

OWNER'S MANUAL

Operation
Maintenance
Specifications

All information in this Owner's Manual is current at the time of publication. However, Genesis Branded Vehicle reserves the right to make changes at any time so that our policy of continual product improvement may be carried out.

This manual applies to all models of this vehicle and includes descriptions and explanations of optional as well as standard equipment.

As a result, you may find material in this manual that does not apply to your specific vehicle.

Please note that some models are equipped with Right-Hand Drive (RHD). The explanations and illustrations for some operations in RHD models are opposite of those written in this manual.

CAUTION: MODIFICATIONS TO YOUR GENESIS BRANDED VEHICLE

Your Genesis Branded Vehicle should not be modified in any way. Such modifications may adversely affect the performance, safety or durability of your Genesis Branded Vehicle and may, in addition, violate conditions of the limited warranties covering the vehicle. Certain modifications may also be in violation of regulations established by the Department of Transportation and other government agencies in your country.

TWO-WAY RADIO OR CELLULAR TELEPHONE INSTALLATION

Your vehicle is equipped with electronic fuel injection and other electronic components. It is possible for an improperly installed/adjusted two-way radio or cellular telephone to adversely affect electronic systems. For this reason, we recommend that you carefully follow the radio manufacturer's instructions or consult your authorized retailer of Genesis Branded products for precautionary measures or special instructions if you choose to install one of these devices.

WARNING! (IF EQUIPPED)

The vehicle is equipped with a device of the system Pan-European eCall or UAE eCALL which calls emergency services. Any self- or unauthorized interference in the system Pan-European eCall or UAE eCALL, in vehicle systems and its components, installing of equipment which is not recommended by vehicle manufacturer and/or in authorized retailer of Genesis Branded products can cause incorrect operation (of the device of) the system Pan-European eCall or UAE eCALL, making erroneous calls, causing failure of the device (in cars) in case of traffic accident or other accidents, when you need emergency care.

This may be dangerous and threaten your life!

SAFETY AND VEHICLE DAMAGE WARNING

This manual includes information titled as DANGER, WARNING, CAUTION and NOTICE.

These titles indicate the following:



DANGER

DANGER indicates a hazardous situation which, if not avoided, will result in death or serious injury.



WARNING

WARNING indicates a hazardous situation which, if not avoided, could result in death or serious injury.



CAUTION

CAUTION indicates a hazardous situation which, if not avoided, could result in minor or moderate injury.

NOTICE

NOTICE indicates a situation which, if not avoided, could result in vehicle damage.

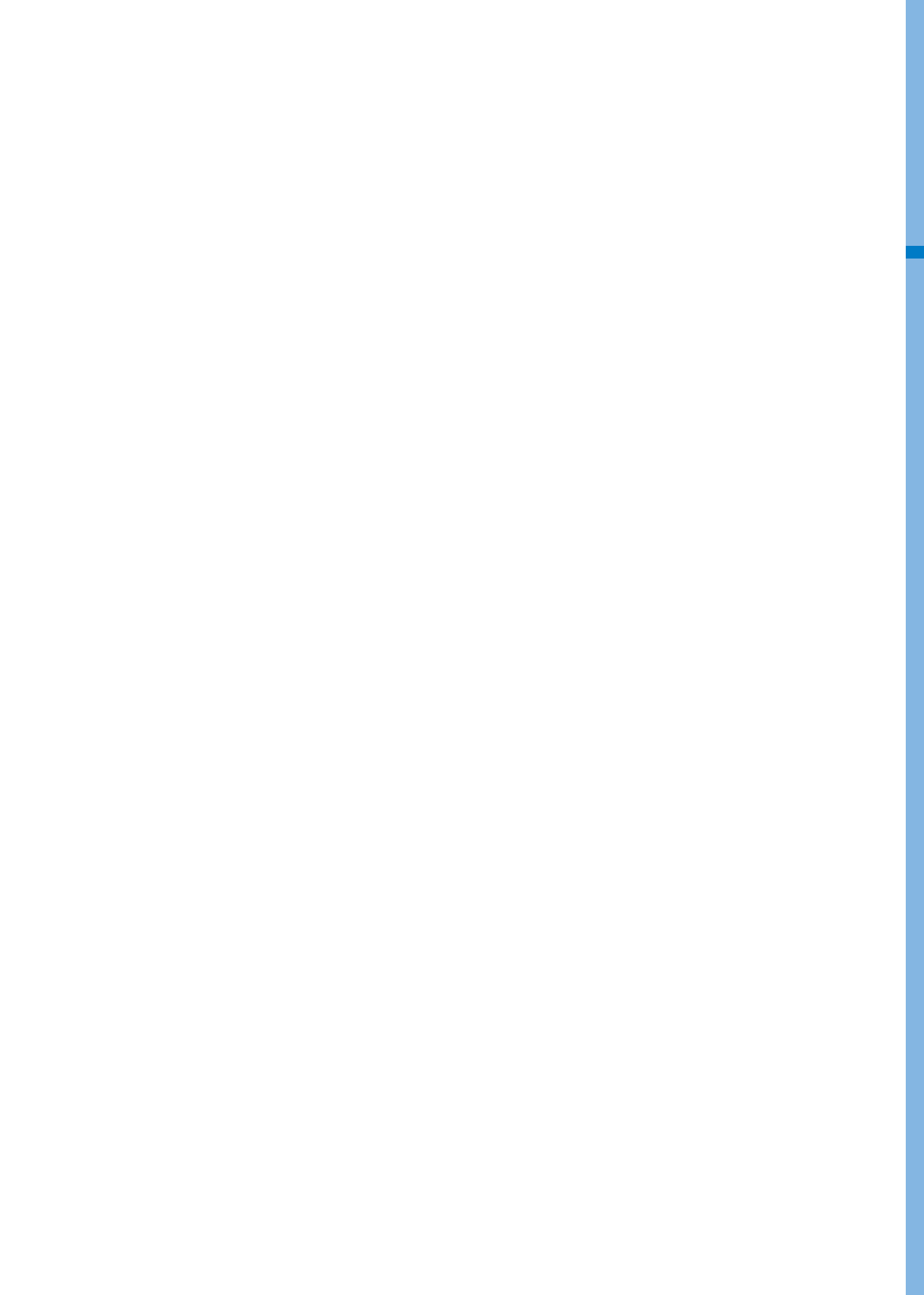

Table of contents

Foreword	1
Vehicle information	2
Safety system	3
Instrument cluster	4
Convenience features	5
Driving your vehicle	6
Driver assistance system	7
Emergency situations	8
Maintenance	9
Index	I

FOREWORD

Congratulations, and thank you for choosing Genesis Branded Vehicle. We are pleased to welcome you to the growing number of discerning people who drive Genesis Branded Vehicle. We are very proud of the advanced engineering and high-quality construction of each Genesis Branded Vehicle we build.

Your Owner's Manual will introduce you to the features and operation of your new Genesis Branded Vehicle. To become familiar with your new Genesis Branded Vehicle, so that you can fully enjoy it, read this Owner's Manual carefully before driving your new vehicle.

This manual contains important safety information and instructions intended to familiarize you with your vehicle's controls and safety features so you can safely operate your vehicle.

This manual also contains information on maintenance designed to enhance safe operation of the vehicle. It is recommended that all service and maintenance on your car be performed by an authorized retailer of Genesis Branded products. An authorized retailer of Genesis Branded products are prepared to provide high-quality service, maintenance and any other assistance that may be required.

This Owner's Manual should be considered a permanent part of your vehicle, and should be kept in the vehicle so you can refer to it at any time. The manual should stay with the vehicle if you sell it to provide the next owner with important operating, safety and maintenance information.

GENESIS BRAND MOTOR COMPANY



CAUTION

Severe engine and transmission damage may result from the use of poor quality fuels and lubricants that do not meet Genesis Branded Vehicle specifications. You must always use high quality fuels and lubricants that meet the specifications listed on Page 2-15 in the Vehicle Specifications section of the Owner's Manual.

Copyright 2021 Genesis Brand Motor Company. All rights reserved. No part of this publication may be reproduced, stored in any retrieval system or transmitted in any form or by any means without the prior written permission of Genesis Brand Motor Company.

HOW TO USE THIS MANUAL

We want to help you get the greatest possible driving pleasure from your vehicle. Your Owner's Manual can assist you in many ways. We strongly recommend that you read the entire manual. In order to minimize the chance of death or injury, you must read the WARNING and CAUTION sections in the manual.

Illustrations complement the words in this manual to best explain how to enjoy your vehicle. By reading your manual, you will learn about features, important safety information, and driving tips under various road conditions.

The general layout of the manual is provided in the Table of Contents. Use the index when looking for a specific area or subject; it has an alphabetical listing of all information in your manual.

Sections: This manual has nine chapters plus an index. Each chapter begins with a brief list of contents so you can tell at a glance if that section has the information you want.

SAFETY MESSAGES

Your safety, and the safety of others, is very important. This Owner's Manual provides you with many safety precautions and operating procedures. This information alerts you to potential hazards that may hurt you or others, as well as damage to your vehicle. Safety messages found on vehicle labels and in this manual describe these hazards and what to do to avoid or reduce the risks.

Warnings and instructions contained in this manual are for your safety. Failure to follow safety warnings and instructions can lead to serious injury or death.

Throughout this manual DANGER, WARNING, CAUTION, NOTICE and the SAFETY ALERT SYMBOL will be used.



This is the safety alert symbol. It is used to alert you to potential physical injury hazards. Obey all safety messages that follow this symbol to avoid possible injury or death. The safety alert symbol precedes the signal words DANGER, WARNING and CAUTION.



DANGER

DANGER indicates a hazardous situation which, if not avoided, will result in death or serious injury.



WARNING

WARNING indicates a hazardous situation which, if not avoided, could result in death or serious injury.



CAUTION

CAUTION indicates a hazardous situation which, if not avoided, could result in minor or moderate injury.

NOTICE

NOTICE indicates a situation which, if not avoided, could result in vehicle damage.

FUEL REQUIREMENTS

Gasoline engine

Unleaded

For the optimal vehicle performance, we recommend you use unleaded gasoline which has an octane rating of RON (Research Octane Number) 95 / AKI (Anti Knock Index) 91 or higher. You may use unleaded gasoline with an octane rating of RON 91-94 / AKI 87-90 but it may result in slight performance reduction of the vehicle. (Do not use methanol blended fuels)

Your new vehicle is designed to obtain maximum performance with UNLEADED FUEL, as well as minimize exhaust emissions and spark plug fouling.

NOTICE

NEVER USE LEADED FUEL. The use of leaded fuel is detrimental to the catalytic converter and will damage the engine control system's oxygen sensor and affect emission control.

Never add any fuel system cleaning agents to the fuel tank other than what has been specified (We recommend that you consult an authorized retailer of Genesis Branded products for details.)



WARNING

- Do not "top off" after the nozzle automatically shuts off when refueling.
- Always check that the fuel cap is installed securely to prevent fuel spillage in the event of an accident.

Gasoline containing alcohol and methanol

Gasohol, a mixture of gasoline and ethanol (also known as grain alcohol), and gasoline or gasohol containing methanol (also known as wood alcohol) are being marketed along with or instead of leaded or unleaded gasoline.

Do not use gasohol containing more than 10% ethanol, and do not use gasoline or gasohol containing any methanol. Either of these fuels may cause drivability problems and damage to the fuel system, engine control system and emission control system.

Discontinue using gasohol of any kind if drivability problems occur.

Vehicle damage or driveability problems may not be covered by the manufacturer's warranty if they result from the use of:

1. Gasohol containing more than 10% ethanol.
2. Gasoline or gasohol containing methanol.
3. Leaded fuel or leaded gasohol.

NOTICE

Never use gasohol which contains methanol. Discontinue use of any gasohol product which impairs drivability.

Other fuels

Using fuel additives such as:

- Silicone fuel additive
- MMT (Magnanese, Mn) fuel additive
- Ferrocene (iron-based) fuel additive
- Other metallic-based fuel additives

may result in cylinder misfire, poor acceleration, engine stalling, damage to the catalyst, or abnormal corrosion, and may cause damage to the engine resulting in a reduction in the overall life of the powertrain.

NOTICE

Damage to the fuel system or performance problem caused by the use of these fuels may not be covered by your New Vehicle Limited Warranty.

Use of MTBE

Genesis Branded Vehicle recommends avoiding fuels containing MTBE (Methyl Tertiary Butyl Ether) over 15.0% vol. (Oxygen Content 2.7% weight) in your vehicle.

Fuel containing MTBE over 15.0% vol. (Oxygen Content 2.7% weight) may reduce vehicle performance and produce vapor lock or hard starting.

NOTICE

Your New Vehicle Limited Warranty may not cover damage to the fuel system and any performance problems that are caused by the use of fuels containing methanol or fuels containing MTBE (Methyl Tertiary Butyl Ether) over 15.0% vol. (Oxygen Content 2.7% weight.)

Do not use methanol

Fuels containing methanol (wood alcohol) should not be used in your vehicle. This type of fuel can reduce vehicle performance and damage components of the fuel system, engine control system and emission control system.

Fuel Additives

Genesis Branded Vehicle recommends that you use unleaded gasoline which has an octane rating of RON (Research Octane Number) 95 / AKI (Anti Knock Index) 91 or higher. For customers who do not use good quality gasolines, and have problems starting or the engine does not run smoothly, one bottle of additive added to the fuel tank is recommended according to the maintenance schedule (**refer to chapter 9, “Normal Maintenance Schedule”**).

Additives are available from your authorized retailer of Genesis Branded products along with information on how to use them. Do not mix other additives.

Operation in foreign countries

If you are going to drive your vehicle in another country, be sure to:

- Observe all regulations regarding registration and insurance.
- Determine that acceptable fuel is available.

Diesel engine

Diesel fuel

Diesel engine must be operated only on commercially available diesel fuel that complies with EN 590 or comparable standard. (EN stands for “European Norm”). Do not use marine diesel fuel, heating oils, or non-approved fuel additives, as this will increase wear and cause damage to the engine and fuel system.

The use of non-approved fuels and/or fuel additives will result in a limitation of your warranty rights.

Diesel fuel of above cetane 51 is used in your vehicle. If two types of diesel fuel are available, use summer or winter fuel properly according to the following temperature conditions.

- Above -5°C (23°F) ... Summer type diesel fuel.
- Below -5°C (23°F) ... Winter type diesel fuel.

Watch the fuel level in the tank very carefully : If the engine stops through fuel failure, the circuits must be completely purged to permit restarting.

NOTICE

Do not let any gasoline or water enter the tank. This would make it necessary to drain it out and to bleed the lines to avoid jamming the injection pump and damaging the engine.

NOTICE

Diesel Fuel (if equipped with DPF)

It is recommended to use regulated automotive diesel fuel for diesel vehicle equipped with the DPF system. If you use diesel fuel including high sulfur (more than 50 ppm sulfur) and unspecified additives, it can cause the DPF system to be damaged and white smoke can be emitted.

Biodiesel

Commercially supplied Diesel blends of no more than 7% biodiesel, commonly known as “B7 Diesel” may be used in your vehicle if Biodiesel meets EN 14214 or equivalent specifications. (EN stands for “European Norm”). The use of biofuels exceeding 7% made from rapeseed methyl ester (RME), fatty acid methyl ester (FAME), vegetable oil methyl ester (VME) etc. or mixing diesel exceeding 7% with biodiesel will cause increased wear or damage to the engine and fuel system. Repair or replacement of worn or damaged components due to the use of non approved fuels will not be covered by the manufactures warranty.

NOTICE

- **Never use any fuel that fails to meet the latest petroleum industry specification.**
- **Never use any fuel additives or treatments that are not recommended or approved by the vehicle manufacturer.**

VEHICLE MODIFICATIONS

- This vehicle should not be modified. Modification of your vehicle could affect its performance, safety or durability and may even violate governmental safety and emissions regulations.

In addition, damage or performance problems resulting from any modification may not be covered under warranty.

- If you use unauthorized electronic devices, it may cause the vehicle to operate abnormally, wire damage, battery discharge and fire. For your safety, do not use unauthorized electronic devices.

NOTICE

Some warning sounds (including welcome/good-bye sound, etc.) are generated from the interior speakers or amplifiers. If necessary, we recommend you to purchase Genesis/Hyundai Part to replace an interior speaker or amplifier. Any unauthorized product may cause a malfunction of the interior speakers or amplifiers.

VEHICLE BREAK-IN PROCESS

By following a few simple precautions for the first 1,000 km (600 miles) you may add to the performance, economy and life of your vehicle.

- Do not race the engine.
- While driving, keep your engine speed (RPM, or revolutions per minute) between 2,000 RPM and 4,000 RPM (Gasoline engine) or within 3,000 RPM (Diesel engine).
- Do not maintain a single speed for long periods of time, either fast or slow. Varying engine speed is needed to properly break-in the engine.
- Avoid hard stops, except in emergencies, to allow the brakes to seat properly.
- Fuel economy and engine performance may vary depending on vehicle break-in process and be stabilized after 6,000 km (4,000 miles). New engines may consume more oil during the vehicle break-in period.
- Do not tow a trailer during the first 2,000 km (1,200 miles) of operation.

RETURNING USED VEHICLES (FOR EUROPE)

Genesis Branded Vehicle promotes an environmentally sound treatment for end of life vehicles and offers to take back your Genesis Branded Vehicle end of life vehicles in accordance with the European Union (EU) End of Life Vehicles Directive.

You can get detailed information from your national Genesis Branded Vehicle homepage.

2. Vehicle information

Exterior overview (I).....	2-2
Exterior overview (II).....	2-3
Interior overview (I)	2-4
Interior overview (II)	2-5
Instrument panel overview (I).....	2-6
Instrument panel overview (II).....	2-7
Instrument panel overview (III).....	2-8
Engine compartment (I)	2-9
Engine compartment (II).....	2-10
Dimensions.....	2-11
Engine.....	2-11
Bulb wattage	2-12
Tires and wheels	2-13
Load and speed capacity tires (for europe)	2-14
Air conditioning system.....	2-14
Vehicle weight and luggage volume	2-14
Recommended lubricants and capacities	2-15
Recommended SAE viscosity number	2-16
Vehicle Identification Number (VIN)	2-18
Vehicle certification label.....	2-18
Tire specification and pressure label.....	2-19
Engine number.....	2-19
Air conditioner compressor label	2-20
Declaration of conformity	2-20
Fuel label	2-21
Gasoline engine.....	2-21
Diesel engine	2-21

EXTERIOR OVERVIEW (I)

■ Front view



- | | | | |
|----------------------------------|------|--------------------------------------|------------|
| 1. Hood..... | 5-48 | 5. Sunroof..... | 5-43 |
| 2. Headlamp..... | 9-76 | 6. Front windshield wiper blades ... | 5-79, 9-39 |
| 3. Tires and wheels..... | 9-45 | 7. Windows | 5-38 |
| 4. Outside rearview mirror | 5-34 | 8. Front radar | 7-4 |

EXTERIOR OVERVIEW (II)

■ Rear view

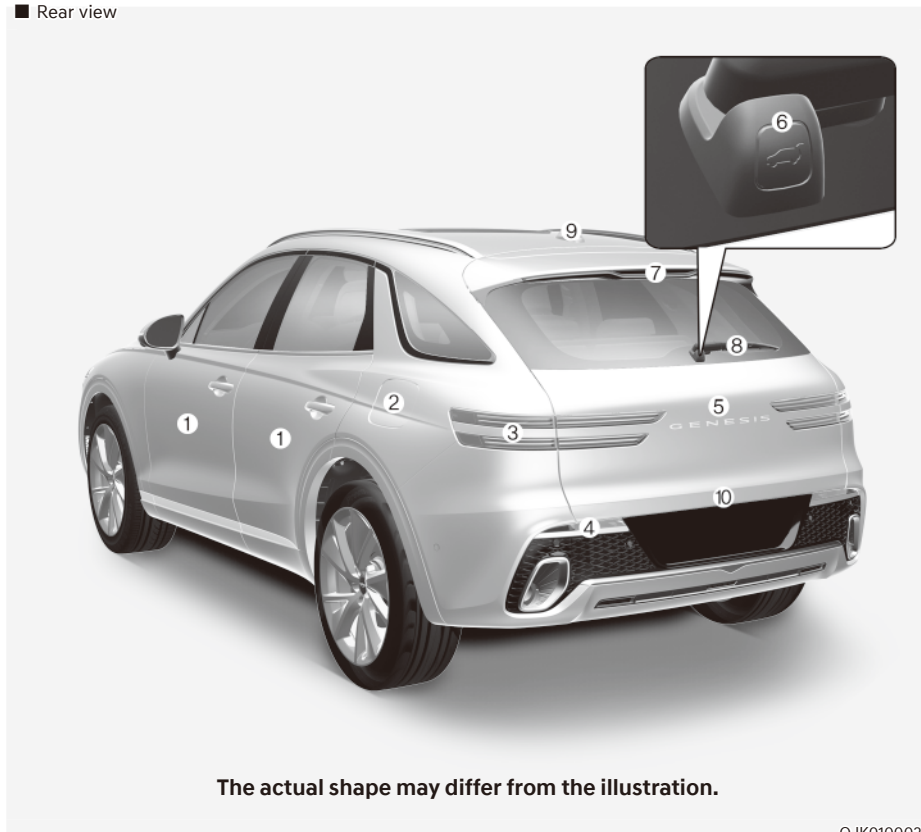

OJK010002

- | | | | |
|-------------------------------|------|------------------------------------|-------|
| 1. Door..... | 5-15 | 6. Tailgate open/close button..... | 5-52 |
| 2. Fuel filler door..... | 5-58 | 7. High mounted stop lamp..... | 9-80 |
| 3. Rear combination lamp..... | 9-79 | 8. Rear window wiper blades..... | 9-40 |
| 4. Reverse lamp..... | 9-79 | 9. Antenna..... | 5-120 |
| 5. Tailgate..... | 5-49 | 10. Rear view camera..... | 7-120 |

INTERIOR OVERVIEW (I)

■ Left-hand drive



The actual shape may differ from the illustration.

OJK010003

- | | | | |
|--|------|--|------|
| 1. Inside door handle..... | 5-16 | 10. DBC (Downhill Brake Control) button..... | 6-38 |
| 2. Integrated memory system | 5-26 | 11. ESC (Electronic Stability Control) OFF button..... | 6-32 |
| 3. Outside rearview mirror control switch | 5-35 | 12. Power tailgate open/close button..... | 5-51 |
| 4. Outside rearview mirror folding button | 5-35 | 13. EPB (Electronic Parking Brake) switch | 6-23 |
| 5. Central door lock switch | 5-17 | 14. Hood release lever..... | 5-48 |
| 6. Power window switches | 5-38 | 15. Steering wheel tilt/telescopic switch.. | 5-30 |
| 7. Power window lock button / | 5-41 | 16. Steering wheel | 5-29 |
| Electronic child safety lock button..... | 5-20 | 17. Seat..... | 3-3 |
| 8. ISG (Idle Stop & Go) OFF button..... | 6-54 | | |
| 9. Instrument panel illumination control switch..... | 4-5 | | |

INTERIOR OVERVIEW (II)

■ Right-hand drive



The actual shape may differ from the illustration.

OJK010003R

- | | | | |
|---|------|--|------|
| 1. Inside door handle..... | 5-16 | 10. DBC (Downhill Brake Control) button..... | 6-38 |
| 2. Integrated memory system | 5-26 | 11. ESC (Electronic Stability Control) OFF button..... | 6-32 |
| 3. Outside rearview mirror control switch | 5-35 | 12. Power tailgate open/close button..... | 5-51 |
| 4. Outside rearview mirror folding button | 5-35 | 13. EPB (Electronic Parking Brake) switch | 6-23 |
| 5. Central door lock switch | 5-17 | 14. Hood release lever..... | 5-48 |
| 6. Power window switches | 5-38 | 15. Steering wheel tilt/telescopic switch.. | 5-30 |
| 7. Power window lock button / | 5-41 | 16. Steering wheel..... | 5-29 |
| Electronic child safety lock button..... | 5-20 | 17. Seat..... | 3-3 |
| 8. ISG (Idle Stop & Go) OFF button..... | 6-54 | | |
| 9. Instrument panel illumination control switch | 4-5 | | |

INSTRUMENT PANEL OVERVIEW (I)

■ Left-hand drive



The actual shape may differ from the illustration.

OJK010004L

1. Instrument cluster	4-4	13. Wireless charging system pad.....	5-112
2. Horn.....	5-31	14. Cup holder	5-107
3. Driver's front air bag.....	3-52	15. Rotary shifter (Rotary gear shift dial).....	6-13
4. Engine Start/Stop button.....	6-6	16. Auto Hold button.....	6-27
5. Infotainment system	5-121	17. Drive mode button /	6-43
6. Hazard warning flasher button.....	8-3	Terrain mode button.....	6-43
7. Automatic climate control	5-83	18. Parking/View button	7-121
8. Passenger's front air bag	3-52	19. Parking Safety button.....	7-145
9. Glove box	5-105	20. Rear seat climate control	5-87
10. Wireless charging system indicator	5-112	21. Rear seat USB charger	5-110
11. USB port.....	5-120	22. Power outlet /	5-109
12. USB charger	5-110	AC inverter	5-111

INSTRUMENT PANEL OVERVIEW (II)

■ Right-hand drive



The actual shape may differ from the illustration.

OJK010004R

- | | | | |
|--|-------|--|-------|
| 1. Instrument cluster | 4-4 | 13. Wireless charging system pad | 5-112 |
| 2. Horn | 5-31 | 14. Cup holder | 5-107 |
| 3. Driver's front air bag | 3-52 | 15. Rotary shifter
(Rotary gear shift dial) | 6-13 |
| 4. Engine Start/Stop button | 6-6 | 16. Auto Hold button | 6-27 |
| 5. Infotainment system | 5-121 | 17. Drive mode button / | 6-43 |
| 6. Hazard warning flasher button | 8-3 | Terrain mode button | 6-43 |
| 7. Automatic climate control system | 5-83 | 18. Parking/View button | 7-121 |
| 8. Passenger's front air bag | 3-52 | 19. Parking Safety button | 7-145 |
| 9. Glove box | 5-105 | 20. Rear seat climate control | 5-87 |
| 10. Wireless charging system indicator | 5-112 | 21. Rear seat USB charger | 5-110 |
| 11. USB port | 5-120 | 22. Power outlet / | 5-109 |
| 12. USB charger | 5-110 | AC inverter | 5-111 |

INSTRUMENT PANEL OVERVIEW (III)

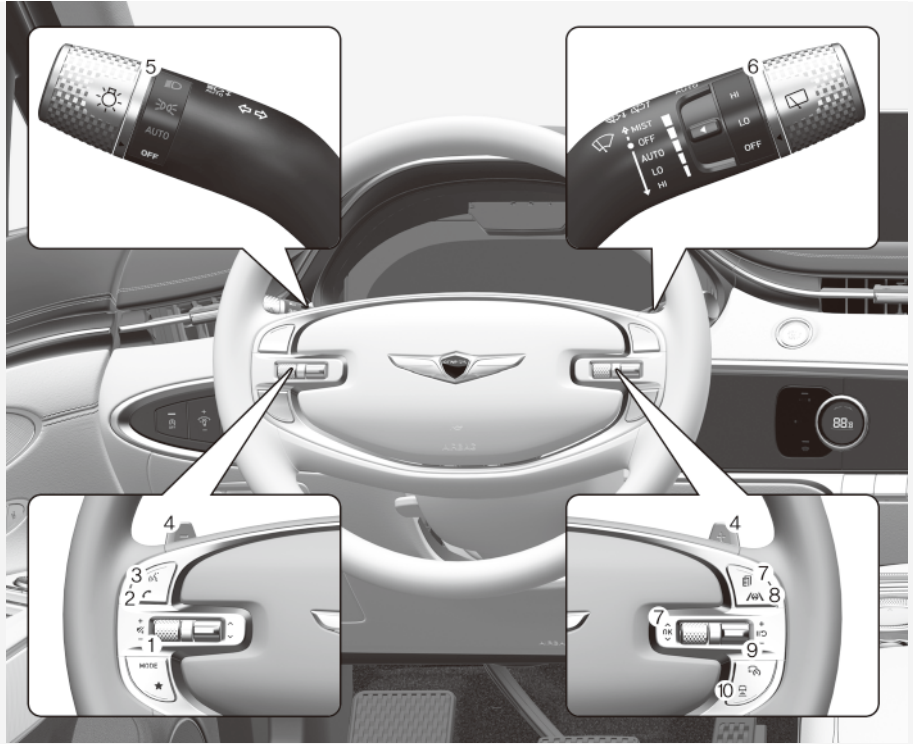

The actual shape may differ from the illustration.

OJK010005

- | | |
|---|-------------|
| 1. Audio remote control buttons | 5-120 |
| 2. Bluetooth® hands-free phone button | 5-122 |
| 3. Voice recognition button | 5-121 |
| 4. Paddle shifter | 6-20 |
| 5. Lighting control lever | 5-63 |
| 6. Wiper and washer control lever..... | 5-79 |
| 7. LCD display control | 4-32 |
| 8. Lane Driving Assist button..... | 7-27, 7-104 |
| 9. Driving Assist button | 7-59 |
| 10. Vehicle Distance button..... | 7-80 |

ENGINE COMPARTMENT (I)

■ 2.5 T-GDI

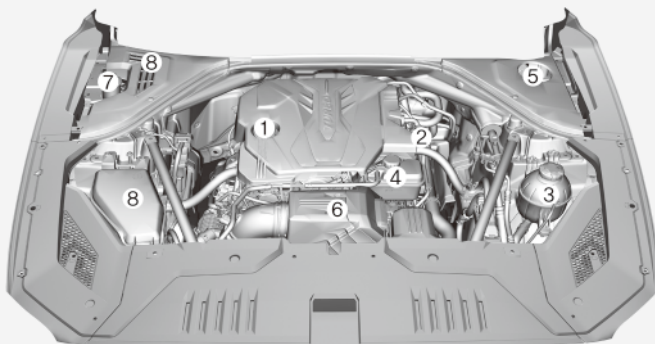

■ 3.5 T-GDI

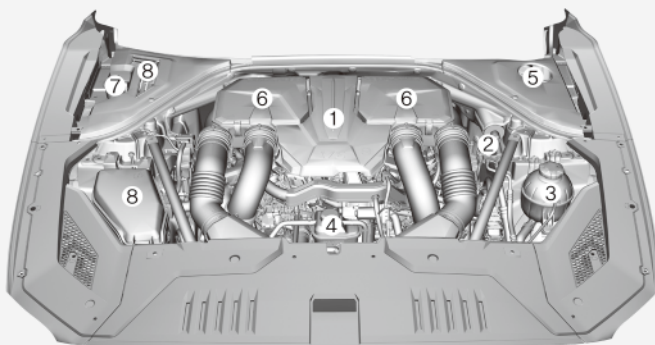

The actual engine compartment in the vehicle may differ from the illustration.

OJK091001N/OJK090002L

- | | | | |
|--|------|--|------|
| 1. Engine oil filler cap | 9-29 | 5. Brake fluid reservoir | 9-35 |
| 2. Engine oil dipstick | 9-28 | 6. Air cleaner | 9-37 |
| 3. Engine coolant reservoir | 9-32 | 7. Windshield washer fluid reservoir | 9-36 |
| 4. Liquid-cooled intercooler
coolant reservoir..... | 9-32 | 8. Fuse box | 9-55 |

ENGINE COMPARTMENT (II)

■ 2.2 TCI

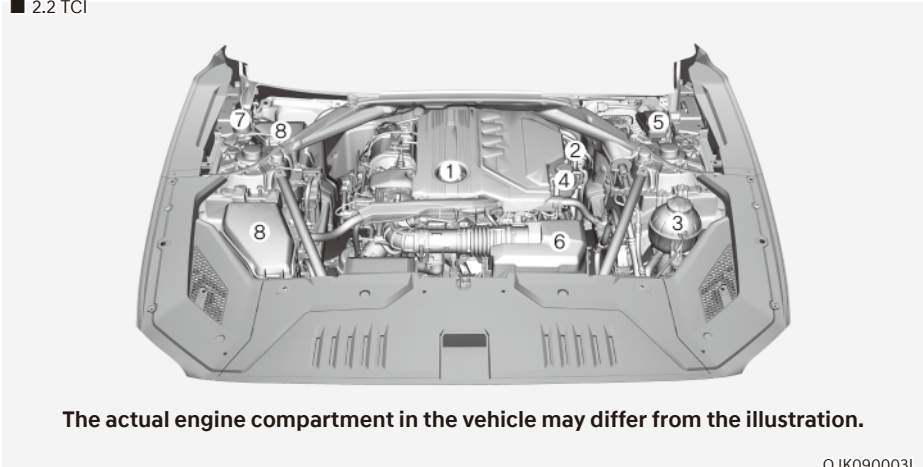

- | | | | |
|--|------|--|------|
| 1. Engine oil filler cap | 9-29 | 5. Brake fluid reservoir | 9-35 |
| 2. Engine oil dipstick | 9-28 | 6. Air cleaner | 9-37 |
| 3. Engine coolant reservoir | 9-32 | 7. Windshield washer fluid reservoir | 9-36 |
| 4. Liquid-cooled intercooler
coolant reservoir..... | 9-32 | 8. Fuse box..... | 9-55 |

DIMENSIONS

Items		mm (in)	
Overall length		4,715 (185.63)	
Overall width		1,910 (75.20)	
Overall height		1,630 (64.17)	
Tread	Tire size	Front	Rear
	18 in	1,651 (65)	1,667 (65.63)
	19 in	1,649 (64.92)	1,665 (65.55)
	21 in	1,641 (64.60)	1,657 (65.24)
Wheelbase		2,875 (113.19)	

ENGINE

Engine	Displacement cc (cu. in)	Bore x Stroke mm (in.)	Firing order	No. of cylinders
2.5 T-GDI	2497 (152.4)	88.5 x 101.5 (3.5 x 4)	1-3-4-2	4
3.5 T-GDI	3470 (211.8)	92 x 87 (3.6 x 3.4)	1-2-3-4-5-6	6
2.2 TCI	2151 (131.3)	83 x 99.4 (3.3 x 3.9)	1-3-4-2	4

BULB WATTAGE

Light bulb		Bulb type	Wattage
Front	Headlamp	Low	LED
		High, Low beam assist	LED
	Turn signal lamp		LED
	Position lamp		LED
	Daytime Running Lamp (DRL)		LED
	Puddle lamp		LED
Rear	Stop lamp		LED
	Tail lamp		LED
	Turn signal lamp		LED
	Reverse lamp		LED
	License plate lamp		LED
	Fog lamp		LED
High mounted stop lamp		LED	
Interior	Front seat map and room lamp		LED
	Rear seat room lamp (without sunroof)		LED
	Rear seat personal lamp (with sunroof)		LED
	Vanity mirror lamp		LED
	Glove box lamp		LED
	Handle lamp / Mood lamp / Door courtesy lamp		LED
	Luggage compartment lamp		LED

TIRES AND WHEELS

Items	Tire size	Wheel size	Inflation pressure kPa (psi)				Wheel bolt torque kgf-m (lbf-ft, N-m)
			Normal load		Maximum load		
			Front	Rear	Front	Rear	
Full size tire	235/60R18	8.0J X 18	230 (33)	250 (36)	240 (35)	260 (38)	14~16 (101~116, 137~157)
	235/55R19	8.0J X 19	230 (33)	250 (36)	240 (35)	260 (38)	
	255/40R21	9.0J X 21	230 (33)	260 (38)	240 (35)	280 (41)	
Compact spare tire	T155/90R18	4.0T X 18	420 (60)	420 (60)	420 (60)	420 (60)	
	T155/80R19	4.0T X 19	420 (60)	420 (60)	420 (60)	420 (60)	

NOTICE

- Ambient temperature affects the tire pressure (about 7kPa (psi) for every 7°C (12°F) change). If colder temperatures are anticipated, it is permissible to increase cold tire inflation pressure by up to 20 kPa (3 psi) over the specification. If extreme temperature changes are expected, be sure to check and adjust tire pressure accordingly.
- Tire inflation pressure decreases with higher elevation, and increases with lower elevation (about 10 kPa (2.4 psi) for every kilometer (or mile) elevation change). Be sure to check and adjust tire pressure accordingly when driving through changing elevations.
- Do not exceed the maximum inflation pressure, as found on the sidewall of the tire(s).



CAUTION

When replacing tires, **ALWAYS** use the same size, type, brand, construction and tread pattern supplied with the vehicle. If not, it can damage the related parts or make it work irregularly.

LOAD AND SPEED CAPACITY TIRES (FOR EUROPE)

Items	Tire size	Wheel size	Load capacity		Speed capacity	
			LI *1	kg	SS *2	km/h
Full size tire	235/60R18	8.0J X 18	107	975	W	270
	235/55R19	8.0J x 19	105	925	W	270
	255/40R21	9.0J x 21	102	850	Y	300
Compact spare tire	T155/90R18	4.0T X 18	107	975	M	130
	T155/80R19	4.0T X 19	105	925	M	130

*1 LI : LOAD INDEX

*2 SS : SPEED SYMBOL

AIR CONDITIONING SYSTEM

Item		Weight of volume	Classification
Refrigerant	Type A	625±25 g (22.05±0.88 oz.)	R-1234yf
	Type B	675±25 g (23.81±0.88 oz.)	R-134a
Compressor lubricant		100±10 g (3.52±0.35 oz.)	PAG

We recommend that you contact an authorized retailer of Genesis Branded products dealer for more details.

VEHICLE WEIGHT AND LUGGAGE VOLUME

Item	2.5 T-GDI		3.5 T-GDI	2.2 TCI	
	2WD	AWD	AWD	2WD	AWD
Gross vehicle weight	2,435 kg (5368 lbs.)	2,500 kg (5512 lbs.)	2,585 kg (5699 lbs.)	2,480 kg (5467 lbs.)	2,545 kg (5611 lbs.)

Luggage volume		
2.5 T-GDI	3.5 T-GDI	2.2 TCI
542 ℓ (19.1 cu.ft)		

RECOMMENDED LUBRICANTS AND CAPACITIES

To help achieve proper engine and powertrain performance and durability, use only lubricants of the proper quality. The correct lubricants also help promote engine efficiency that results in improved fuel economy.

These lubricants and fluids are recommended for use in your vehicle.

Lubricant		Volume	Classification
Engine oil *1 *2 Recommends	2.5 T-GDI	6.2 ℓ (6.5 US qt.)	API SN PLUS /SP or ILSAC GF-6 *3 SAE: 0W-30
	3.5 T-GDI	7.0 ℓ (7.4 US qt.)	API SN PLUS/SP or ILSAC GF-6 *3 SAE: 0W-30
	Except Middle East* For Middle East*		ACEA A5/B5 *4 SAE: 5W-30
	2.2 TCI	5.6 ℓ (5.9 US qt.)	ACEA C5 (or C3 or C2) SAE: 0W-20
Urea solution (Diesel engine)		14 ℓ (15 US qt.)	ISO 22241 or DIN 70070
Automatic transmission fluid		9.2 ℓ (9.7 US qt.)	GS ATF SP-IV-RR, Genesis/ HYUNDAI genuine ATF SP-IV- RR
Engine coolant	2.5 T-GDI	8.6 ℓ (9.1 US qt.)	Mixture of antifreeze and water (Phosphate-based Ethylene glycol coolant for aluminum radiator)
	3.5 T-GDI	9.7 ℓ (10.2 US qt.)	
	2.2 TCI	8.9 ℓ (9.4 US qt.)	
Liquid-cooled intercooler coolant	2.5 T-GDI	1.48 ℓ (1.56 US qt.)	
	3.5 T-GDI	1.48 ℓ (1.56 US qt.)	
	2.2 TCI	2.0 ℓ (2.11 US qt.)	
Brake fluid *5		As required	SAE J1704 DOT0-4LV, FMVSS116 DOT-4, ISO4925 CLASS-6
Front differential oil (AWD) *6		0.67±0.025 ℓ (0.71±0.026 US qt.)	HYPOID GEAR OIL API GL-5 SAE 75W/85 (SK HK SYN GEAR OIL 75W85 FM PLUS OR EQUIVALENT)
Rear differential oil *6		1.2±0.05 ℓ (1.27±0.05 US qt.)	HYPOID GEAR OIL API GL-5 SAE 75W/85 (SK HK SYN GEAR OIL 75W85 FM PLUS OR EQUIVALENT)

Lubricant	Volume	Classification
Transfer case oil (AWD)	Gear/Clutch : 0.42 ± 0.021 ℓ (0.44 ± 0.022 US qt.) Actuator : 0.27 ± 0.010 ℓ (0.28 ± 0.011 US qt.)	SHELL TF0870B
e-LSD oil	0.41 ± 0.015 ℓ (0.43 ± 0.016 US qt.)	SHELL TF0870C
Fuel	66 ℓ (17.43 US gal.)	Refer to “Fuel requirements” in chapter 1.

* Middle East includes Livia, Algeria, Iran, Morocco, Sudan, Tunisia and Egypt

*1: Refer to the recommended SAE viscosity numbers on the next page.

*2: Engine oils labeled Energy Conserving Oil are now available. Along with other additional benefits, they contribute to fuel economy by reducing the amount of fuel necessary to overcome engine friction. Often, these improvements are difficult to measure in everyday driving, but in a year’s time, they can offer significant cost and energy savings.

*3: Requires < API SN PLUS (or above) Full synthetic> grade engine oil. If a lower grade engine oil (mineral oil including Semi-synthetic) is used, then the engine oil and engine oil filter must be replaced as indicated severe maintenance condition.

*4: Requires <ACEA A5/B5 Full synthetic> grade engine oil. If a lower grade engine oil (mineral oil including Semi-synthetic) is used, then the engine oil and engine oil filter must be replaced as indicated severe maintenance condition.

*5: To maintain the best braking performance and ABS/ESC performance, we recommend that you use genuine brake fluid that conform to specifications.

*6: If the front/rear differential is submerged, we recommend that you visit an authorized retailer of Genesis Branded products to replace the differential oil.

Recommended SAE viscosity number



CAUTION

Always be sure to clean the area around any filler plug, drain plug, or dipstick before checking or draining any lubricant. This is especially important in dusty or sandy areas and when the vehicle is used on unpaved roads. Cleaning the plug and dipstick areas will prevent dirt and grit from entering the engine and other mechanisms that could be damaged.

Engine oil viscosity (thickness) has an effect on fuel economy and cold weather operating (engine start and engine oil flowability). Lower viscosity engine oils can provide better fuel economy and cold weather performance, however, higher viscosity engine oils are required for satisfactory lubrication in hot weather. Using oils of any viscosity other than those recommended could result in engine damage.

When choosing an oil, consider the range of temperature your vehicle will be operated in before the next oil change. Proceed to select the recommended oil viscosity from the chart.

		Temperature Range for SAE Viscosity Numbers										
Temperature		°C	-30	-20	-10	0	10	20	30	40	50	
		(°F)	-10	0	20	40	60	80	100	120		
Gasoline Engine Oil	2.5 T-GDI		0W-30									
	3.5 T-GDI (except Middle East*)		0W-30									
	3.5 T-GDI (for Middle East*)		5W-30									
Diesel Engine Oil	2.2 TCI		5W-30									
			0W-20/30									

* Middle East includes Livia, Algeria, Iran, Morocco, Sudan, Tunisia and Egypt



An engine oil displaying this American Petroleum Institute (API) Certification Mark conforms to the International Lubricant Specification Advisory Committee (ILSAC). It is recommended to only use engine oils that uphold this API Certification Mark.

VEHICLE IDENTIFICATION NUMBER (VIN)

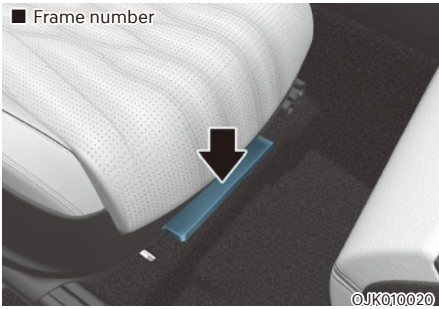

The vehicle identification number (VIN) is the number used in registering your vehicle and in all legal matters pertaining to its ownership, etc.

The number is punched on the floor under the right front seat. To check the number, open the cover.

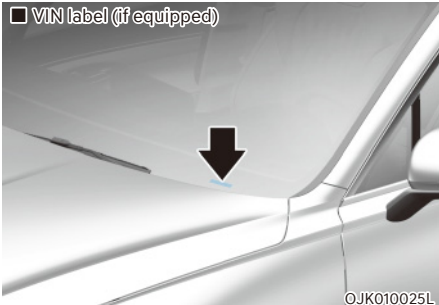

The VIN is also on a plate attached to the top of the left side dashboard. The number on the plate can easily be seen through the windshield from outside.

VEHICLE CERTIFICATION LABEL



The vehicle certification label attached on the driver's (or front passenger's) side center pillar gives the vehicle identification number (VIN).

TIRE SPECIFICATION AND PRESSURE LABEL



The tires supplied on your new vehicle are chosen to provide the best performance for normal driving. The tire label located on the driver's side center pillar gives the tire pressures recommended for your vehicle.

ENGINE NUMBER

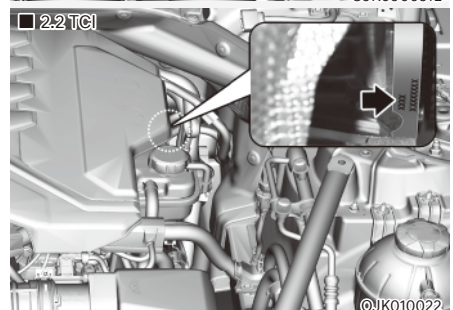
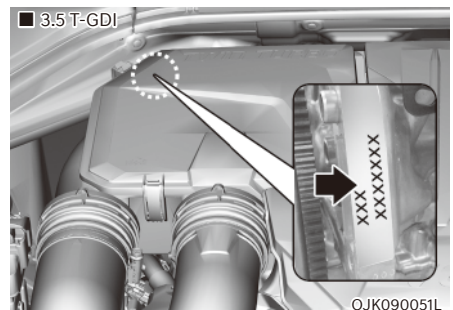
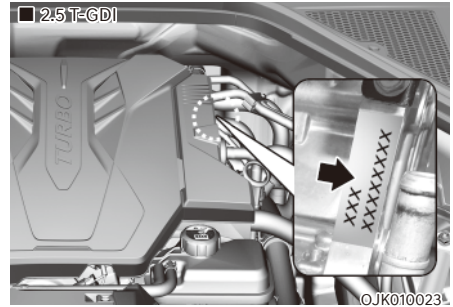

The engine number is stamped on the engine block as shown in the drawing.

AIR CONDITIONER COMPRESSOR LABEL

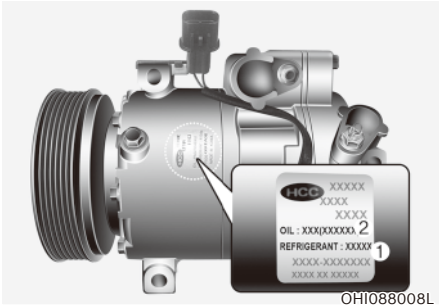

A compressor label informs you the type of compressor your vehicle is equipped with such as model, supplier part number, production number, refrigerant (1) and refrigerant oil (2).

DECLARATION OF CONFORMITY (IF EQUIPPED)

■ Example

CE CE 0678

CE0678

The radio frequency components of the vehicle comply with requirements and other relevant provisions of Directive 1995/5/EC.

Further information including the manufacturer's declaration of conformity is available on Genesis Branded Vehicle web site as follows;

<http://service.hyundai-motor.com>

FUEL LABEL (IF EQUIPPED)

Gasoline engine

The fuel label is attached on the fuel filler door.



- A. Octane rating of unleaded gasoline
 1. RON/ROZ : Research Octane Number
 2. (R+M)/2, AKI : Anti Knock Index
- B. Identifiers for Petrol-type fuels
 - * This symbol means usable fuel. Do not use any other fuel.
- C. For further details, refer to the “Fuel Requirement” section in the chapter 1.

Diesel engine

The fuel label is attached on the fuel filler door.

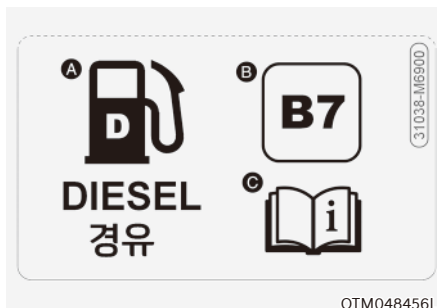

- A. Fuel : Diesel
- B. Identifiers for FAME containing Diesel-type fuels
 - * This symbol means usable fuel. Do not use any other fuel.
- C. For further details, refer to the “Fuel Requirement” section in the chapter 1.

3. Safety system

Important safety precautions	3-2
Always wear your seat belt	3-2
Restrain all children.....	3-2
Air bag hazards.....	3-2
Driver distraction.....	3-2
Control your speed.....	3-2
Keep your vehicle in safe condition	3-2
Seats	3-3
Safety precautions	3-6
Front seats	3-7
Rear seats	3-12
Headrest.....	3-16
Seat warmers.....	3-20
Air ventilation seats.....	3-23
Seat belts.....	3-26
Seat belt safety precautions.....	3-26
Seat belt warning light.....	3-27
Seat belt restraint system	3-29
Pre-Active Seat Belt (PSB).....	3-33
Additional seat belt safety precautions	3-34
Care of seat belts.....	3-36
Child Restraint System (CRS).....	3-37
Our recommendation: Children always in the rear.....	3-37
Selecting a Child Restraint System (CRS).....	3-38
Installing a Child Restraint System (CRS)	3-40
Air bag - supplemental restraint system	3-49
Where are the air bags?	3-52
How does the air bags system operate?.....	3-57
What to expect after an air bag inflates	3-60
Why didn't my air bag go off in a collision?.....	3-61
SRS care.....	3-66
Additional safety precautions.....	3-67
Air bag warning labels.....	3-67

IMPORTANT SAFETY PRECAUTIONS

You will find many safety precautions and recommendations throughout this section, and throughout this manual. The safety precautions in this section are among the most important.

Always wear your seat belt

A seat belt is your best protection in all types of accidents. Air bags are designed to supplement seat belts, not replace them. So even though your vehicle is equipped with air bags, ALWAYS make sure you and your passengers wear your seat belts, and wear them properly.

Restrain all children

All children under age 13 should ride in your vehicle properly restrained in a rear seat, not the front seat. Infants and small children should be restrained in an appropriate Child Restraint System. Larger children should use a booster seat with the lap/shoulder belt until they can use the seat belt properly without a booster seat.

Air bag hazards

While air bags can save lives, they can also cause serious or fatal injuries to occupants who sit too close to them, or who are not properly restrained. Infants, young children, and short adults are at the greatest risk of being injured by an inflating air bag. Follow all instructions and warnings in this manual.

Driver distraction

Driver distraction presents a serious and potentially deadly danger, especially for inexperienced drivers. Safety should be the first concern when behind the wheel and drivers need to be aware of the wide array of potential distractions, such as drowsiness, reaching for objects, eating, personal grooming, other passengers, and using mobile phones.

Drivers can become distracted when they take their eyes and attention off the road or their hands off the wheel to focus on activities other than driving. To reduce your risk of distraction and an accident:

- ALWAYS set up your mobile devices (for example, MP3 players, phones, navigation units, etc.) when your vehicle is parked or safely stopped.
- ONLY use your mobile device when allowed by laws and conditions permit safe use. NEVER text or email while driving. Most countries have laws prohibiting drivers from texting. Some countries and cities also prohibit drivers from using handheld phones.
- NEVER let the use of a mobile device distract you from driving. You have a responsibility to your passengers and others on the road to always drive safely, with your hands on the wheel as well as your eyes and attention on the road.

Control your speed

Excessive speed is a major factor in crash injuries and deaths. Generally, the higher the speed, the greater the risk, but serious injuries can also occur at lower speeds. Never drive faster than is safe for current conditions, regardless of the maximum speed posted.

Keep your vehicle in safe condition

Having a tire blowout or a mechanical failure can be extremely hazardous. To reduce the possibility of such problems, check your tire pressures and condition frequently, and perform all regularly scheduled maintenance.

SEATS

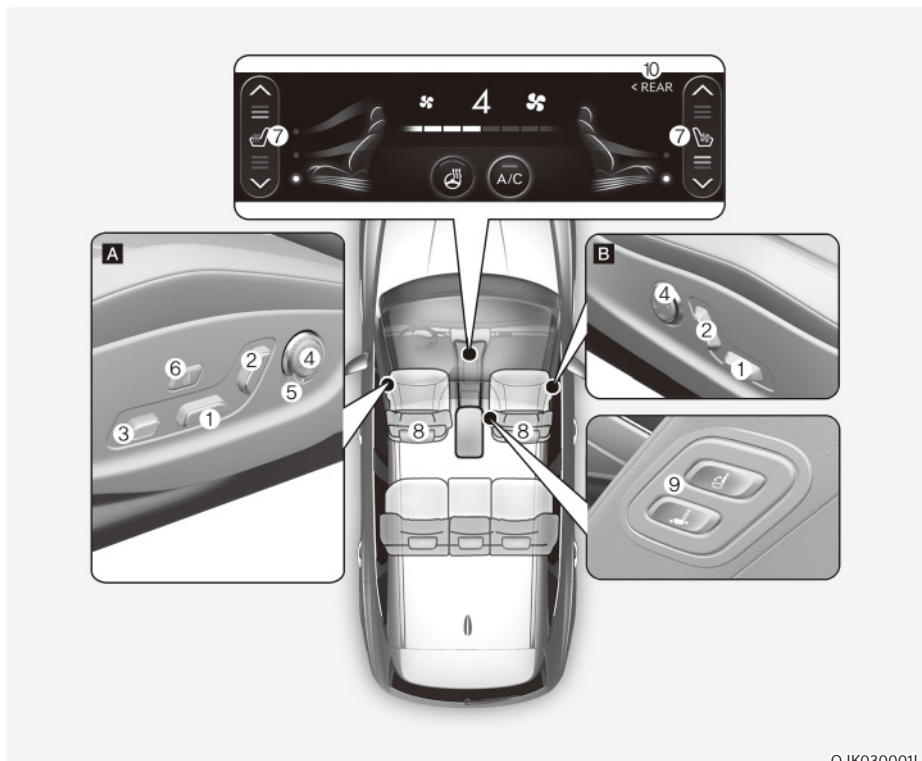

[A] : Driver's side, [B] : Passenger's side

Front seat

- (1) Seat sliding forward or rearward /
Seat cushion tilt /
Seat cushion height
- (2) Seatback angle
- (3) Seat cushion extension /
Seat cushion support
- (4) Lumbar support

- (5) Seatback bolster
- (6) Comfortable stretch
- (7) Seat warmer / Air ventilation seat
- (8) Headrest
- (9) Walk-in seat switch
- (10) Rear adjustment

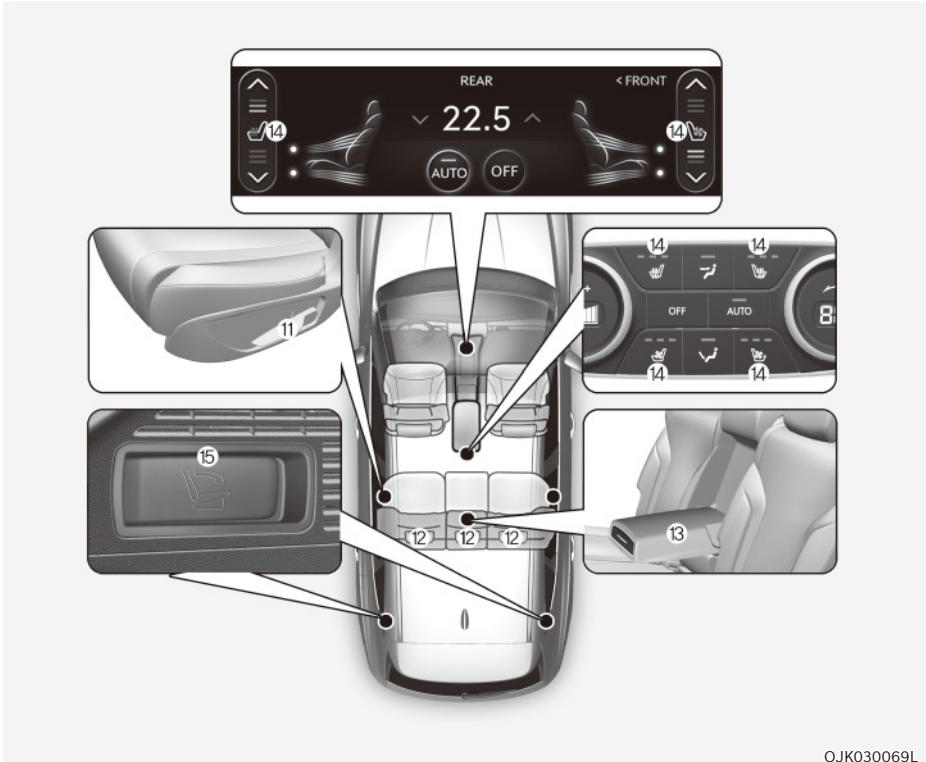

Rear seat

- (11) Seatback angle (Manual)
- (12) Headrest

- (13) Armrest
- (14) Seat warmer / Air ventilation seat
- (15) Seatback remote folding lever

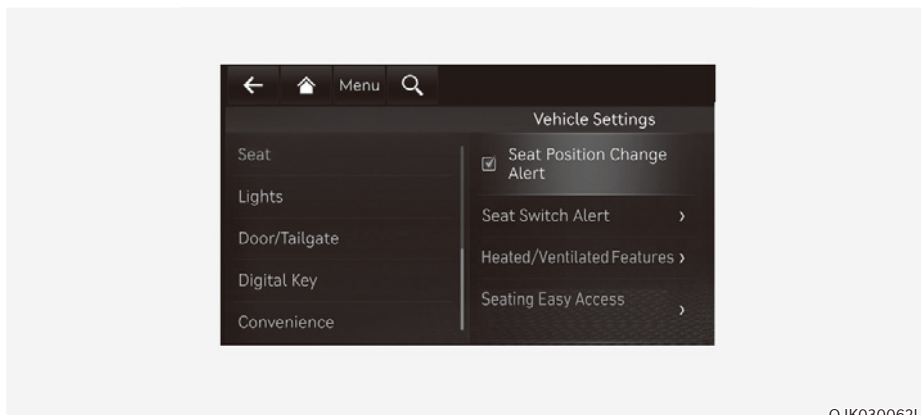

OJK030062L

Infotainment system

Select 'Setup → Vehicle Settings → Seat' from the Settings menu in the infotainment system screen, you may use various convenience functions.

- Seat position change alert : Seat change information is displayed.
- Seat switch alert : Detailed information of the seat switch and image is displayed when the switch is touched or the switch is moved.
- Heated/Ventilated features
 - Auto. Controls That Use Climate Control Settings (for driver's seat) : The seat temperature is automatically controlled.
 - Seat heater balance : When the seat heater is on, you may lower the seat heater (warmer) setting, or may turn the seat heater off for either the seatback or seat cushion.
- Seating easy access
 - Steering wheel easy access : Moves the steering wheel when the driver enters or leaves the vehicle.
 - Driver seat easy access : The distance (Normal/Extended/Off) the seat automatically moves when the driver enters or leaves the vehicle may be selected.
- Ergo-motion seat
 - Comfortable stretch : The operation intensity and operation time for Comfortable Stretch may be selected.
 - Smart posture assist : The seat is adjusted to assist the driver's posture after driving for an hour.
 - Smart support : The driver's seat bolster is increased when SPORT mode is selected or when driving at high speed.

For detailed information, scan the QR code in the separately supplied simple manual.

Information

The information provided may differ depending on which functions are applicable to your vehicle.

Safety precautions

Adjusting the seats so that you are sitting in a safe and comfortable position plays an important role for the safety of the driver and passengers, along with seat belts and air bags when in an accident.

WARNING

Do not use a cushion that reduces friction between the seat and the passenger. The passenger's hips may slide under the lap portion of the seat belt during an accident or a sudden stop.

Serious or fatal internal injuries could result because the seat belt cannot operate properly.

Air bags

You can take steps to reduce the risk of being injured by an inflating air bag. Sitting too close to an air bag greatly increases the risk of injury in the event the air bag inflates. Move your seat as far back as possible from front air bags, while still maintaining control of the vehicle.

WARNING

To reduce the risk of serious injury or death from an inflating air bag, take the following precautions:

- Adjust the driver's seat as far to the rear as possible maintaining the ability to control the vehicle.
- Adjust the front passenger seat as far to the rear as possible.
- Hold the steering wheel by the rim with hands at the 9 o'clock and 3 o'clock positions to minimize the risk of injuries to your hands and arms.
- NEVER place anything or anyone between you and the air bag.
- Do not allow the front passenger to place feet or legs on the dashboard to minimize the risk of leg injuries.

Seat belts

Always fasten your seat belt before starting any trip. At all times, passengers should sit upright and be properly restrained. Infants and small children must be restrained in appropriate Child Restraint Systems. Children who have outgrown a booster seat and adults must be restrained using the seat belts.

WARNING

Take the following precautions when adjusting your seat belt:

- NEVER use one seat belt for more than one occupant.
- Always position the seatback upright with the lap portion of the seat belt snug and low across the hips.
- NEVER allow children or small infants to ride on a passenger's lap.
- Do not route the seat belt across your neck, across sharp edges, or reroute the shoulder strap away from your body.
- Do not allow the seat belt to become caught or jammed.

Front seats

The front seat can be adjusted by using the control switches located on the outside of the seat cushion. Before driving, adjust the seat to the proper position so that you can easily control the steering wheel, foot pedals and controls on the instrument panel.



WARNING

Take the following precautions when adjusting your seat:

- **NEVER** attempt to adjust the seat while the vehicle is moving. The seat could respond with unexpected movement and may cause loss of vehicle control resulting in an accident.
- Do not place anything under the front seats. Loose objects in the driver's foot area could interfere with the operation of the foot pedals, causing an accident.
- Do not allow anything to interfere with the normal position and proper locking of the seatback.
- Do not place a cigarette lighter on the floor or seat. When you operate the seat, gas may exit out of the lighter causing a fire.
- Use extreme caution when picking up small objects trapped under the seats or between the seat and the center console. Your hands might be cut or injured by the sharp edges of the seat mechanism.
- If there are occupants in the rear seats, be careful while adjusting the front seat position.
- Make sure that the seat is locked in place after the adjustment. If not, the seat might move unexpectedly resulting in an accident.



CAUTION

To prevent injury:

- Do not adjust your seat while wearing your seat belt. Moving the seat cushion forward may cause strong pressure on your abdomen.
- Do not allow your hands or fingers to get caught in the seat mechanisms while the seat is moving.



WARNING

NEVER allow children in the vehicle unattended. The power seats are operable when the vehicle is turned off.

NOTICE

To prevent damage to the seats:

- Always stop adjusting the seats when the seat has been adjusted as far forward or rearward as possible.
- Do not adjust the seats longer than necessary when the vehicle is turned off. This may result in unnecessary battery drain.
- Do not operate two or more seats at the same time. This may result in an electrical malfunction.

Forward and rearward adjustment

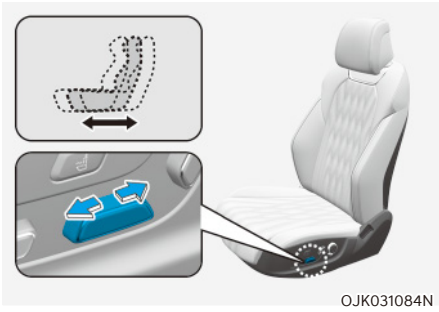

To move the seat forward or rearward:

1. Push the control switch forward or rearward.
2. Release the switch once the seat reaches the desired position.

Seat cushion tilt/height adjustment

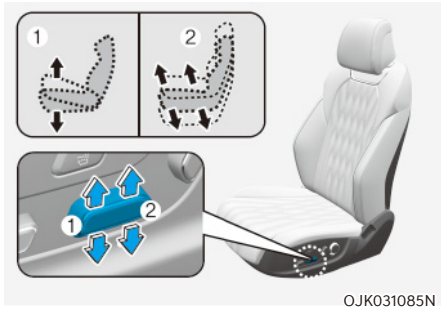

Seat cushion tilt (1)

To change the angle of the front part of the seat cushion:

Push the front portion of the control switch up to raise or down to lower the front part of the seat cushion.

Release the switch once the seat reaches the desired position.

Seat cushion height (2)

To change the height of the seat cushion:

Push the rear portion of the control switch up to raise or down to lower the height of the seat cushion.

Release the switch once the seat reaches the desired position.

Seatback angle adjustment

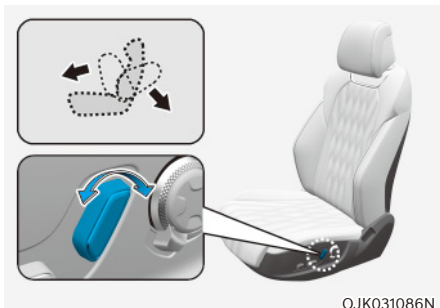

To recline the seatback:

1. Push the control switch forward or rearward.
2. Release the switch once the seatback reaches the desired position.

Reclining seatback

Sitting in a reclined position when the vehicle is in motion can be dangerous. Even when buckled up, the protections of your restraint system (seat belts and air bags) is greatly reduced by reclining your seatback.



WARNING

NEVER ride with a reclined seatback when the vehicle is moving.

Riding with a reclined seatback increases your chance of serious or fatal injuries in the event of a collision or sudden stop.

Driver and passengers should ALWAYS sit well back in their seats, properly belted, and with the seatbacks upright.

Seat belts must be snug against your hips and chest to work properly. When the seatback is reclined, the shoulder belt cannot do its job because it will not be snug against your chest. Instead, it will be in front of you. During an accident, you could be thrown into the seat belt, causing neck or other injuries.

The more the seatback is reclined, the greater chance the passenger's hips will slide under the lap belt or the passenger's neck will strike the shoulder belt.

Seat cushion extension adjustment (for driver's seat) (if equipped)

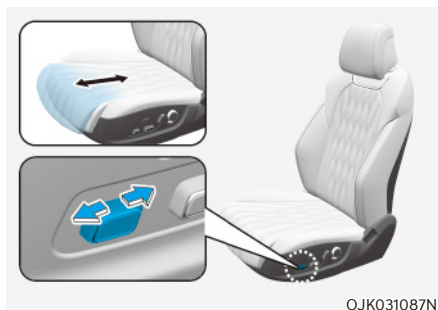

To move the front part of the cushion forward or rearward:

1. Push the control switch forward or rearward.
2. Release the switch once the seat cushion reaches the desired length.

Seat cushion support adjustment (for driver's seat) (if equipped)

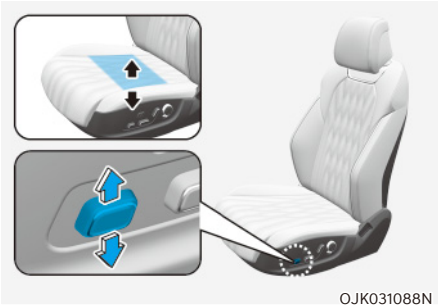

To adjust cushion support:

1. Push the control switch up to increase cushion support or down to decrease cushion support.
2. Release the switch once the seat cushion support reaches the desired position.

Lumbar support (if equipped)

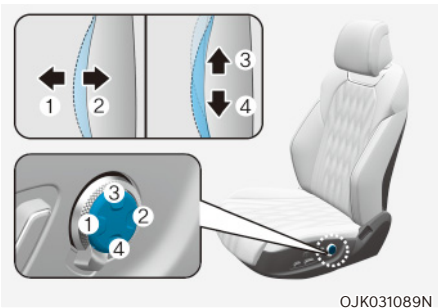

To adjust the lumbar support:

1. Press the front portion of the switch (1) to increase support or the rear portion of the switch (2) to decrease support.
2. Press switch (3) or (4) to move the support position up or down.
3. Release the switch once the lumbar support reaches the desired position.

Seat bolster adjustment (for driver's seat) (if equipped)

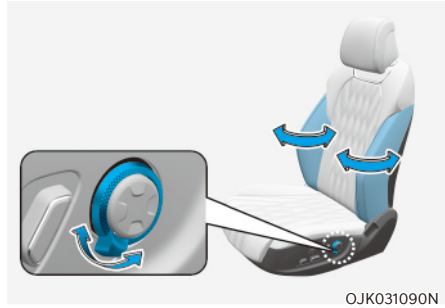

To adjust seat bolster:

1. Push the adjustment lever clockwise, the seatback bolster will be adjusted inward. Push the switch counterclockwise, the seatback bolster will be adjusted outward.
2. Release the lever once the bolster reaches the desired position.

Ergo-motion seat (for driver's seat) (if equipped)

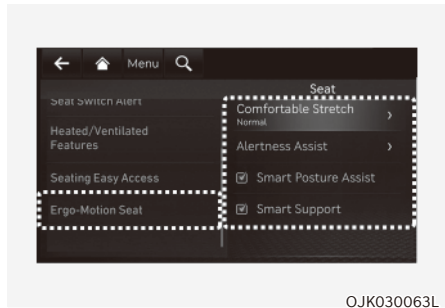

Select 'Ergo-Motion Seat' from the infotainment system's Settings menu to select and set up supplemental functions for the driver.



WARNING

Before actually using each function, try the functions with the vehicle parked.

Comfortable stretch

Comfortable stretch is a function that helps relieve fatigue of the driver's pelvis and lower back due to driving.

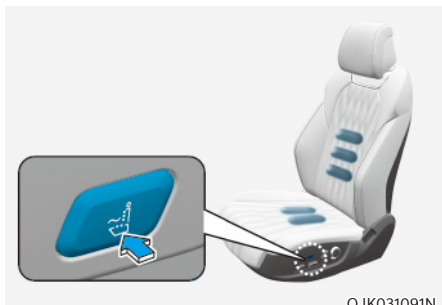

OJK031091N

Every time you press the button, you may select a mode or turn off the function in the following order.

- Pelvic stretching: The cushion portion moves, helping the left and right movement of the pelvis.
- Lumbar stretching: The seatback portion moves, helping back and forth movement of the lower back.
- Whole Body stretching: The cushion and seatback moves in sequence, helping the whole body reduce fatigue.
- Off: Turns off Comfortable Stretch.

Also, you can change the operation intensity and operation time from the Settings menu in the infotainment system screen.

- Intensity: Setup → Vehicle Settings → Seat → Ergo-Motion Seat → Comfortable Stretch → Strong/Normal
- Time: Setup → Vehicle Settings → Seat → Ergo-Motion Seat → Comfortable Stretch → Operational Time → Short(10s)/Long(20s)

Smart posture assist

After driving for an hour, Smart posture assist automatically adjusts the pelvis and back portion of the driver's seat to assist the driver's posture.

You can activate or deactivate Smart posture assist function from the Settings menu in the infotainment system screen. Select:

- Setup → Vehicle Settings → Seat → Ergo-Motion Seat → Smart Posture Assist

Smart support

The driver's seat bolster support increases when SPORT mode is selected for Drive Mode and when driving at high speed.

You can activate or deactivate Posture Assist function from the Settings menu in the infotainment system screen. Select:

- Setup → Vehicle Settings → Seat → Ergo-Motion Seat → Smart Support

Walk-in switch



The rear seat passenger may use the switches to control the front passenger seat.

- Sliding forward or rearward:
Press the switch (1) or (2) to move the front passenger seat forward or rearward.
- Seatback angle:
Press the switch (3) or (4) to recline the front passenger seatback forward or rearward.

Seatback pocket

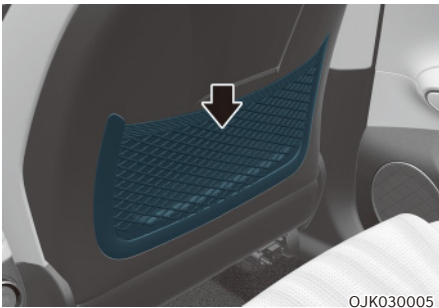

The seatback pocket is provided on the back of the front seatbacks.



CAUTION

Do not put heavy or sharp objects in the seatback pockets. In an accident they could come loose from the pocket and injure occupants.

Rear seats



WARNING

Take the following precautions:

- Adjusting the seats
 - NEVER attempt to adjust the seat while the vehicle is moving. The seat may suddenly move and may injure the passenger.
 - Make sure that the seat is locked in place after the adjustment. If not, the seat might move unexpectedly resulting in an accident.
- Folding the seats
 - Do not fold the seatback when the seat is occupied (for example, passenger, pets or luggage). It may injure the passenger or pet, or damage the luggage.
 - Never allow passengers to sit on top of the folded down seatback while the vehicle is moving. This is not a proper seating position and no seat belts are available for use. This could result in serious injury or death in case of an accident or sudden stop.
 - Objects carried on the folded down seatback should not extend higher than the top of the front seatbacks. This could allow cargo to slide forward and cause injury or damage during sudden stops.

- When returning the rear seatback from a folded to an upright position, hold the seatback and return it slowly. Ensure that the seatback is completely locked into its upright position by pushing on the top of the seatback. In an accident or sudden stop, the unlocked seatback could allow cargo to move forward with great force and enter the passenger compartment, which could result in serious injury or death.
- Loading cargo
 - Make sure the engine is off, the gear shifted to P (Park), and the parking brake is securely applied whenever loading or unloading cargo. Failure to take these steps may allow the vehicle to move if the shift button or shift dial is inadvertently pressed or rotated to another position.
 - When cargo is loaded through the rear passenger seats, ensure the cargo is properly secured to prevent it from moving while driving.
- Do not place objects in the rear seats, since they cannot be properly secured and may hit vehicle occupants in a collision causing serious injury or death.



CAUTION

Do not allow your hands or fingers to get caught in the seat mechanisms while adjusting the seats.

NOTICE

To prevent damage to the vehicle:

- Rear seat belts
 - Before folding the seatback, insert the seat belt buckle in the holder between the seatback and cushion. And insert the seat belt webbing in the guide to prevent the seat belt from being damaged.
- Cargo
 - Be careful when loading cargo through the rear passenger seats to prevent damage to the vehicle interior.

Manual adjustment

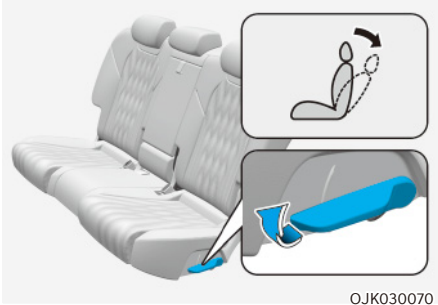

Seatback angle

To recline the seatback:

1. Pull up the seatback recline lever.
2. Hold the lever and adjust the seatback of the seat to the position you desire.
3. Release the lever and make sure the seatback is locked in place. The lever **MUST** return to its original position for the seatback to lock.

* The seatbacks can be folded with the seatback recline lever.

Folding the rear seats

The rear seatbacks can be folded to facilitate carrying long items or to increase the luggage capacity of the vehicle.

To fold down the rear seatback:

1. Set the front seatback to the upright position and if necessary, slide the front seat forward.

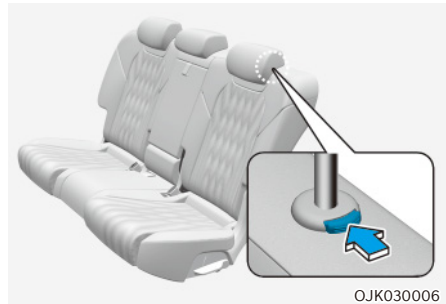

2. Lower the rear headrests to the lowest position.

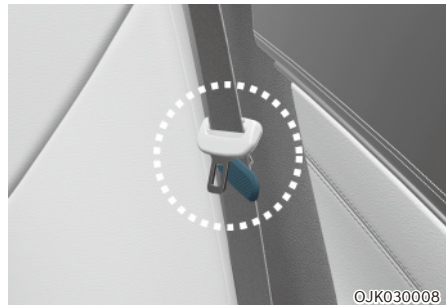

3. Route the seat belt webbing through the rear seat belt guides to prevent the belts from being trapped behind or under the seats.

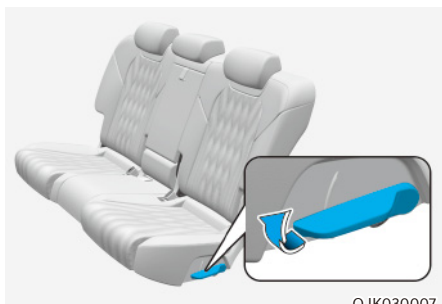

OJK030007

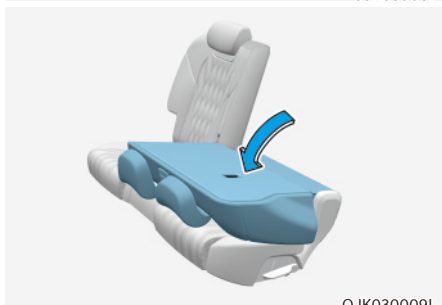

OJK030009L

4. Pull up the seatback folding lever, then fold the seat toward the front of the vehicle. When you return the seatback to its upright position, always be sure it has locked into position by pushing on the top of the seatback.

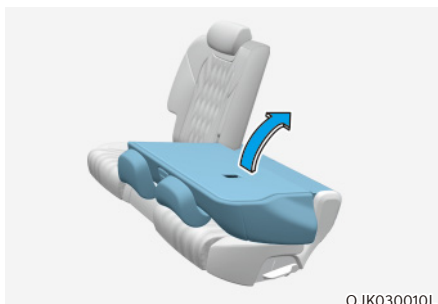

OJK030010L

5. To use the rear seat, lift and unfold the seatback to the upright position by pulling up the folding lever. Push the seatback firmly until it clicks into place. Make sure the seatback is locked in place.
6. Return the rear seat belt to the proper position.

Seatback remote folding

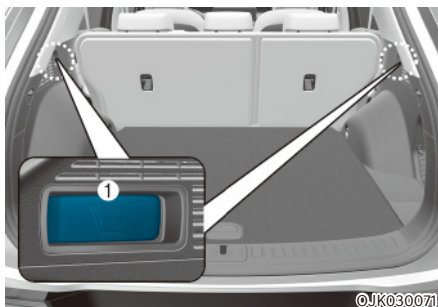

OJK030071

Pull the rear seat back folding switch (1) located in the both sides of the cargo area.

Armrest



The armrest is located in the center of the rear seat. Pull the armrest down from the seatback to use it.

Headrest

The vehicle's front and rear seats have adjustable headrests. The headrests provide comfort for passengers, but more importantly they are designed to help protect passengers from whiplash and other neck and spinal injuries during an accident, especially in a rear impact collision.



WARNING

To help reduce the risk of serious injury or death in an accident, take the following precautions when adjusting your headrests:

- Always properly adjust the headrests for all passengers **BEFORE** starting the vehicle.
- **NEVER** let anyone ride in a seat with the headrest removed or reversed.

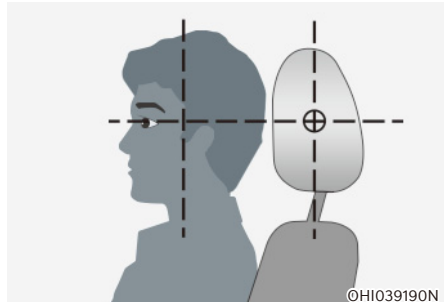

- Adjust the headrests so the middle of the headrest is at the same height as the height of the top of the eyes.
- **NEVER** adjust the headrest position of the driver's seat when the vehicle is in motion.
- Adjust the headrest as close to the passenger's head as possible. Do not use a seat cushion that holds the body away from the seatback.
- Make sure the headrest locks into position after adjusting it.

WARNING

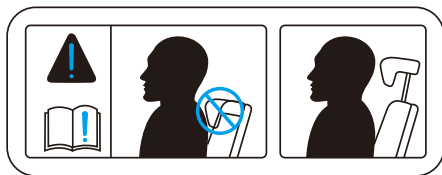

OTL035061

When sitting on the rear seat, do not adjust the height of the headrest to the lowest position.

CAUTION

When there is no occupant in the rear seats, adjust the height of the headrest to the lowest position. The rear seat headrest can reduce the visibility of the rear area.

NOTICE

To prevent damage, NEVER hit or pull on the headrests.

Front seat headrests

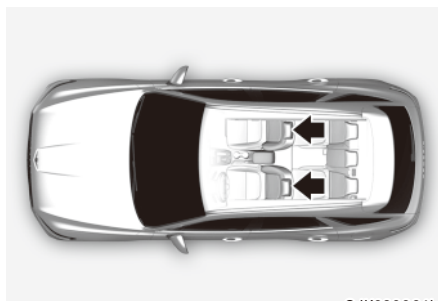

OJK030064L

The driver's and front passenger's seats are equipped with adjustable headrests for the passengers safety and comfort.

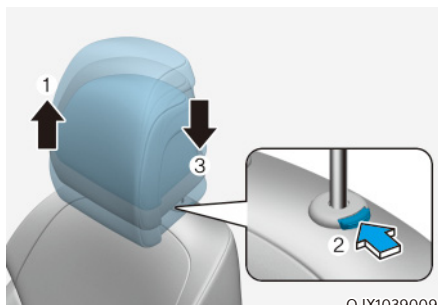

OJX1039009

Adjusting the height up and down

To raise the headrest:

1. Pull it up to the desired position (1).

To lower the headrest:

1. Push and hold the release button (2) on the headrest support.
2. Lower the headrest to the desired position (3).

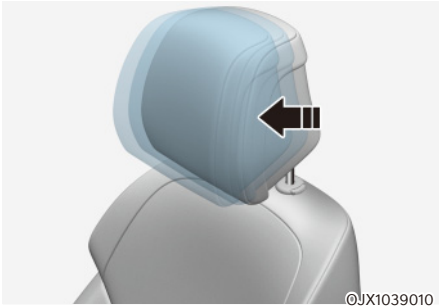

©JX1039010

Forward and rearward adjustment

The headrest may be adjusted forward to 3 different positions by pulling the headrest forward to the desired detent. To adjust the headrest to its furthest rearwards position, pull it fully forward to the farthest position and release it.

NOTICE

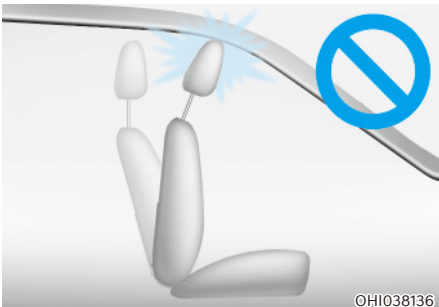

©HI038136

If you recline the seatback towards the front with the headrest and seat cushion raised, the headrest may come in contact with the sunvisor or other parts of the vehicle.

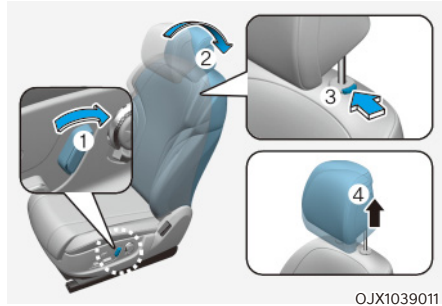

©JX1039011

Removal/Reinstall

To remove the headrest:

1. Recline the seatback (2) with the seatback angle switch (1).
2. Raise the headrest as far as it can go.
3. Press the headrest release button (3) while pulling the headrest up (4).



WARNING

NEVER allow anyone to travel in a seat with the headrest removed.

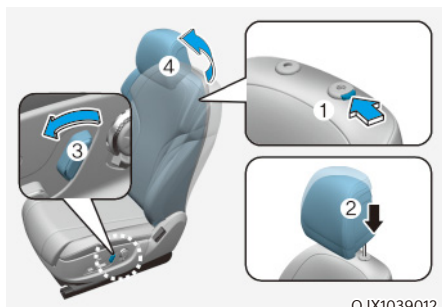

OJX1039012

To reinstall the headrest :

1. Recline the seatback.
2. Put the headrest poles (2) into the holes while pressing the release button (1).
3. Adjust the headrest to the appropriate height.
4. Recline the seatback (4) with the seatback angle switch (3).



WARNING

Always make sure the headrest locks into position after reinstalling and adjusting it properly.

Rear seat headrests

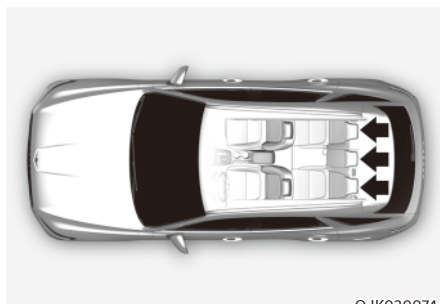

OJK030074

The rear seats are equipped with headrests in all the seating positions for the passenger's safety and comfort.

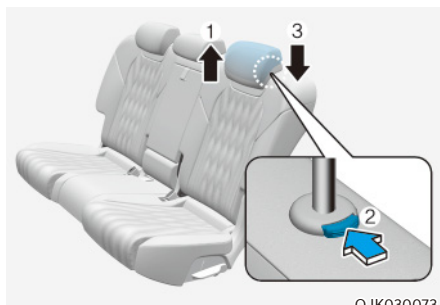

OJK030073

Adjusting the height up and down

To raise the headrest:

1. Pull it up to the desired position (1).

To lower the headrest:

1. Push and hold the release button (2) on the headrest support.
2. Lower the headrest to the desired position (3).

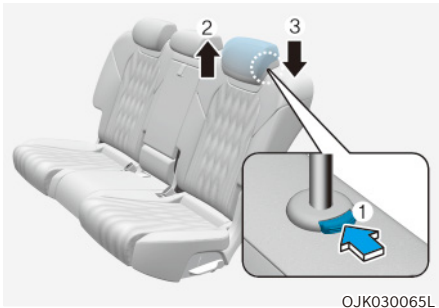

Removal/Reinstallation

To remove the headrest:

1. Raise the headrest as far as it can go.
2. Press the headrest release button (1) while pulling the headrest up (2).

To reinstall the headrest:

1. Put the headrest poles into the holes (3) while pressing the release button (1).
2. Adjust the headrest to the appropriate height.

Seat warmers

Seat warmers are provided to warm the seats during cold weather.

During mild weather or under conditions where the operation of the seat warmer is not needed, keep the seat warmers OFF.

WARNING

The seat warmers can cause a **SERIOUS BURN**, even at low temperatures and especially if used for long periods of time.

Passengers must be able to feel if the seat is becoming too warm so they can turn it off, if needed.

People who cannot detect temperature change or pain to the skin should use extreme caution, especially the following types of passengers:

- Infants, children, elderly or disabled persons, or hospital outpatients.
- People with sensitive skin or who burn easily.
- Fatigued individuals.
- Intoxicated individuals.
- People taking medication that can cause drowsiness or sleepiness.

WARNING

NEVER place anything on the seat that insulates against heat when the seat warmer is in operation, such as a blanket or seat cushion. This may cause the seat warmer to overheat, causing a burn or damage to the seat.

NOTICE



To prevent damage to the seat warmers and seats:



- Never use a solvent such as paint thinner, benzene, alcohol or gasoline to clean the seats.
- Do not place heavy or sharp objects on seats equipped with seat warmers.
- Do not change the seat cover. It may damage the seat warmer.

Front seat warmers



OJK030055L

- While the engine is running, touch either of the  icons to warm the driver's seat or front passenger's seat. The seat warmer will operate and the warning light will illuminate to indicate that the function is in use. You can control the temperature by pressing either  or  icon.

- Manual temperature control
Each time you touch the  or  icon, the temperature setting of the seat is changed as follows :



- Automatic temperature control
The seat warmer starts to automatically control the seat temperature in order to prevent low temperature burns after being manually turned on.

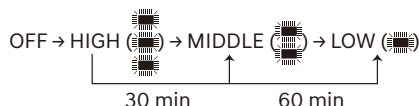

You may manually touch the icon to increase seat temperature. However, the seat temperature is automatically adjusted again.

- Auto. Controls That Use Climate Control Settings (for driver's seat)

The seat warmer automatically controls the seat temperature depending on the ambient temperature when the engine is running.

To use this function, it must be enabled from the Settings menu in the infotainment system screen. Select:

- Setup → Vehicle Settings → Seat → Heated/Ventilated Features → Auto. Controls That Use Climate Control Settings → Seat Warmer/Ventilation

- **Seat Heater Balance**

You may lower the seat warmer setting, or may turn the seat warmer off for either the seatback or seat cushion, when the seat warmer is on.

To use this function, it must be enabled from the Settings menu in the infotainment system screen. Select:

- Setup → Vehicle Settings → Seat → Heated/Ventilated Features → Seat Heater Balance

- When touching the ^ or v icon for more than 1.5 seconds with the seat warmer operating, the seat warmer will turn off.
- The seat warmer defaults to the OFF position whenever the Engine Start/Stop button is pressed to the ON position. However, if the Auto. Controls That Use Climate Control Settings function is On, the driver's seat warmer will turn on and off depending on the ambient temperature.

Rear seat warmers (if equipped)

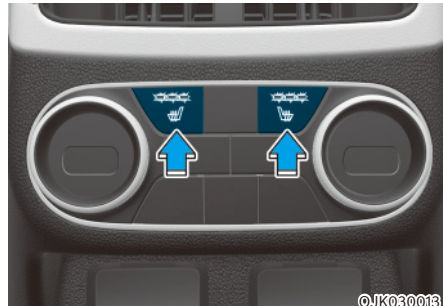

- While the engine is running, press either of the seat warmer switches to warm the rear seat.
- **Manual temperature control**
Each time you press the switch, the temperature setting of the seat is changed as follows :



- **Automatic temperature control**
The seat warmer starts to automatically control the seat temperature in order to prevent low temperature burns after being manually turned on.

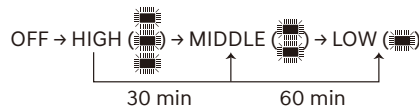

You may manually push the switch to increase seat temperature. However, the seat temperature is automatically adjusted again.

- When pressing the switch for more than 1.5 seconds with the seat warmer operating, the seat warmer will turn off.
- The seat warmer defaults to the OFF position whenever the Engine Start/ Stop button is pressed to the ON position.

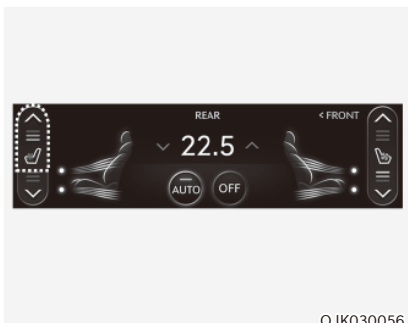

You can also adjust the rear seat warmers from the front seats. With the engine running, touch the seat warmer icon on the climate control system screen.

Air ventilation seats

The air ventilation seats are provided to cool the front seats by blowing air through small vent holes on the surface of the seat cushions and seatbacks.

When the operation of the air ventilation seat is not needed, keep the air ventilation seats OFF.

NOTICE

To prevent damage to the air ventilation seats:

- **Never use a solvent such as paint thinner, benzene, alcohol or gasoline to clean the seats.**
- **Avoid spilling liquids on the surface of the front seats and seatbacks; this may cause the air vent holes to become blocked and not work properly.**
- **Do not place materials such as plastic bags or newspapers under the seats. They may block the air intake causing the air vents to not work properly.**
- **Do not change the seat covers. It may damage the air ventilation seat.**
- **If the air vents do not operate, restart the vehicle. If there is no change, we recommend that you have your vehicle inspected by an authorized retailer of Genesis Branded products.**

**Front air ventilation seats
(if equipped)**



- While the engine is running, touch either of the ^ icons to cool the driver's seat or front passenger's seat. The air ventilation seat will operate and the warning light will illuminate to indicate that the function is in use. You can control the temperature by pressing either ^ or v icon.
- Each time you touch the ^ icon, the airflow changes as follows:



- If the air ventilation seat is positioned at HIGH, the airflow speed will increase according to vehicle speed.
- Use the air ventilation seat with the air conditioning on for more effective ventilation.
- It may take 3~5 minutes after switch operation to feel the temperature change.

- Auto. Controls That Use Climate Control Settings (for driver's seat)
The air ventilation seat automatically controls the seat temperature depending on the ambient temperature when the engine is running.
To use this function, it must be enabled from the Settings menu in the infotainment system screen. Select:
- Setup → Vehicle Settings → Seat → Heated/Ventilated Features → Auto. Controls That Use Climate Control Settings → Seat Warmer/Ventilation
- When touching the ^ or v icon for more than 1.5 seconds with the air ventilation seat operating, the operation will turn off.
- The air ventilation seats defaults to the OFF position whenever the Engine Start/Stop button is pressed to the ON position. However, if the Auto. Controls That Use Climate Control Settings function is on, the driver's seat warmer will turn on and off depending on the ambient temperature.

Rear air ventilation seats (if equipped)

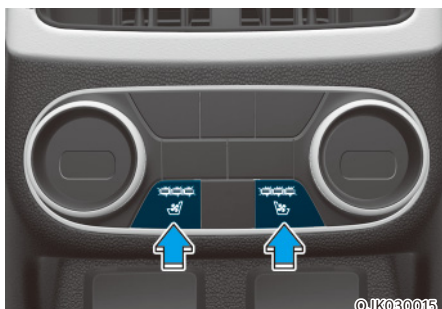

- While the engine is running, press either of the air ventilation switches to cool the seat.
- Each time you press the switch, the air flow changes as follows:



- If the air ventilation seat is positioned at HIGH, the airflow speed will increase according to vehicle speed.
- Use the air ventilation seat with the air conditioning on for more effective ventilation.
- It may take 3~5 minutes after switch operation to feel the temperature change.
- When pressing the switch for more than 1.5 seconds with the air ventilation seat operating, the air ventilation seat will turn off.
- The air ventilation seat defaults to the OFF position whenever the Engine Start/Stop button is pressed to the ON position.

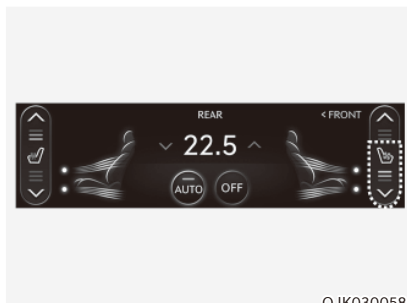

OJK030058

You can also adjust the rear air ventilation seat from the front seats. With the engine running, touch the air ventilation seat icon on the climate control system screen.

SEAT BELTS

This section describes how to use the seat belts properly. It also describes some of the things not to do when using seat belts.

Seat belt safety precautions

Always fasten your seat belt and make sure all passengers have fastened their seat belts before starting any trip. Air bags are designed to supplement the seat belt as an additional safety device, but they are not a substitute. Most countries require all occupants of a vehicle to wear seat belts.



WARNING

Seat belts must be used by **ALL** passengers whenever the vehicle is moving. Take the following precautions when adjusting and wearing seat belts:

- Children under the age of 13 should be properly restrained in the rear seats.
- Never allow children to ride in the front passenger seat, unless the air bag is deactivated. If a child is seated in the front passenger seat, move the seat as far back as possible and properly restrain them in the seat.
- **NEVER** allow an infant or child to be carried on an occupant's lap.
- **NEVER** ride with the seatback reclined when the vehicle is moving.
- Do not allow children to share a seat or seat belt.
- Do not wear the shoulder belt under your arm or behind your back.

- **Never wear a seat belt over fragile objects. If there is a sudden stop or impact, the seat belt can damage it.**
- **Do not use the seat belt if it is twisted. A twisted seat belt will not protect you properly in an accident.**
- **Do not use a seat belt if the webbing or hardware is damaged.**
- **Do not latch the seat belt into the buckles of other seats.**
- **NEVER** unfasten the seat belt while driving. This may cause loss of vehicle control resulting in an accident.
- **Make sure there is nothing in the buckle interfering with the seat belt latch mechanism. This may prevent the seat belt from fastening securely.**
- **No modifications or additions should be made by the user which will either prevent the seat belt adjusting devices from operating to remove slack, or prevent the seat belt assembly from being adjusted to remove slack.**



WARNING

Damaged seat belts and seat belt assemblies will not operate properly. Always replace:

- Frayed, contaminated, or damaged webbing.
- Damaged hardware.
- The entire seat belt assembly after it has been worn in an accident, even if damage to webbing or assembly is not apparent.

Seat belt warning light

Driver's seat belt warning

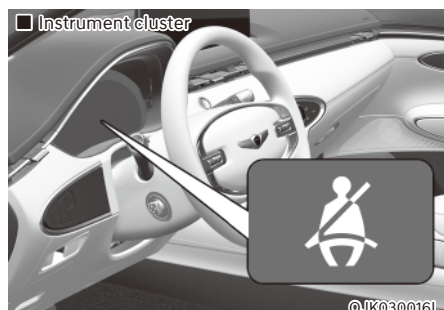

As a reminder to the driver, the seat belt warning light will illuminate for approximately 6 seconds each time the Engine Start/Stop button is in the ON or START position regardless of belt fastening.

If the driver's seat belt is not fastened, the warning chime will sound for about 6 seconds and the warning light will stay ON until the driver's seat belt is fastened.

If the seat belt is not fastened, when vehicle speed is between 9 km/h (5.5 mph) and 20 km/h (12 mph) the warning light will continue to illuminate and warning chime will sound until the seat belt is fastened.

If the seat belt is not fastened, when vehicle speed is above 20 km/h (12 mph), the warning light will blink and warning chime will sound for approximately 100 seconds (warning chime will sound in three stages).

Front passenger's seat belt warning

As a reminder to the front passenger, the front passenger's seat belt warning light will illuminate for approximately 6 seconds each time the Engine Start/Stop button is in the ON or START position regardless of belt fastening.

If the passenger's seat belt is not fastened, the warning light will stay ON until the passenger's seat belt is fastened.

If the seat belt is not fastened, when vehicle speed is above 20 km/h (12 mph), the warning light will blink and warning chime will sound for approximately 100 seconds (warning chime will sound in three stages).

WARNING

Riding in an improper position adversely affects the front passenger's seat belt warning system. It is important for the driver to instruct the passenger to properly be seated as instructed in this manual.

Information

- Although the front passenger seat is not occupied, the seat belt warning light will blink or illuminate for 6 seconds.
- The front passenger's seat belt warning may operate when luggage is placed on the front passenger seat.

Rear passenger's seat belt warning (if equipped)

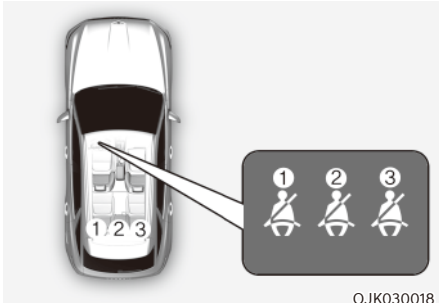

Rear left and right side seatbelt

As a reminder to the rear seat passengers, the corresponding seat belt warning lights will illuminate for approximately 6 seconds each time the Engine Start/Stop button is in the ON or START position regardless of belt fastening.

And then, if the seat belt is still not fastened while driving, or unfastened while driving, it will operate as follows depending on vehicle speed.

Below 20 km/h (12 mph):

The corresponding seat belt warning light will illuminate.

Above 20 km/h (12 mph):

The corresponding seat belt warning light will blink and the warning chime will sound for approximately 35 seconds, and the warning light will continue to illuminate until the seatbelt is fastened.

Rear center seatbelt

With the Engine Start/Stop button in the ON or START position, if the rear center seat passenger's seat belt is not fastened, the corresponding seat belt warning light will illuminate for 70 seconds. But, if the seatbelt is fastened after 6 seconds, the corresponding seat belt warning light will immediately turn off.

If the seat belt is fastened, and then unfastened while driving below 20 km/h (12 mph), the corresponding seat belt warning light will illuminate.

If the seat belt is fastened, and then unfastened while driving above 20 km/h (12 mph), the corresponding seat belt warning light will blink and the warning chime will sound for approximately 35 seconds.

Seat belt restraint system

Lap/shoulder belt

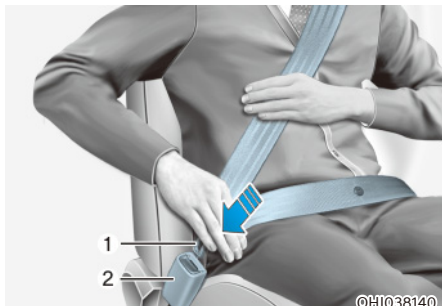

To fasten your seat belt:

Pull it out of the retractor and insert the metal tab (1) into the buckle (2). There will be an audible “click” when the tab locks into the buckle.

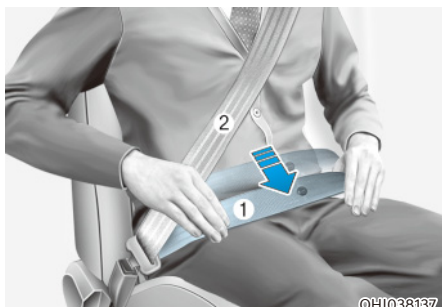

You should place the lap belt (1) portion across your hips and the shoulder belt (2) portion across your chest.

The seat belt automatically adjusts to the proper length after the lap belt portion is adjusted manually so that it fits snugly around your hips. If you lean forward in a slow, easy motion, the belt will extend and move with you.

If there is a sudden stop or impact, the belt will lock into position. It will also lock if you try to lean forward too quickly.

NOTICE

If you are not able to smoothly pull enough of the seat belt out from the retractor, firmly pull the seat belt out and release it. After release, you will be able to pull the belt out smoothly.

WARNING

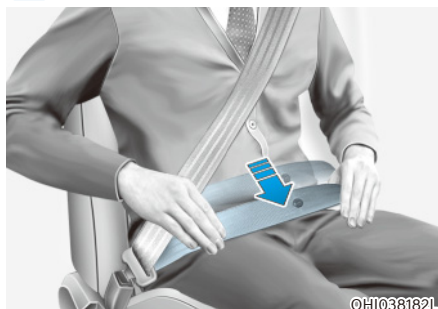

Improperly positioned seat belts may increase the risk of serious injury in an accident. Take the following precautions when adjusting the seat belt:

- Position the lap portion of the seat belt as low as possible across your hips, not on your waist, so that it fits snugly. This allows your strong pelvic bones to absorb the force of the crash, reducing the chance of internal injuries.
- Position one arm under the shoulder belt and the other over the belt, as shown in the illustration.
- Always position the shoulder belt anchor into the locked position at the appropriate height.
- Never position the shoulder belt across your neck or face.

Height adjustment

You can adjust the height of the shoulder belt anchor to one of the four different positions for maximum comfort and safety.

The shoulder portion should be adjusted so it lies across your chest and midway over your shoulder nearest the door, not over your neck.

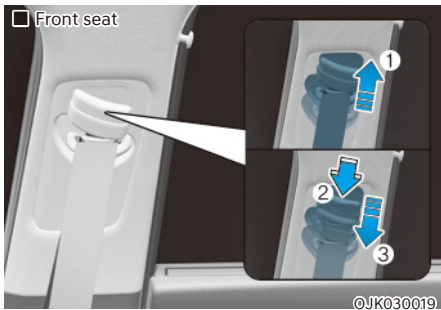

To adjust the height of the seat belt anchor, lower or raise the height adjuster into an appropriate position.

To raise the height adjuster, pull it up (1). To lower it, push it down (3) while pressing the height adjuster button (2).

Release the button to lock the anchor into position. Try sliding the height adjuster to make sure that it has locked into position.

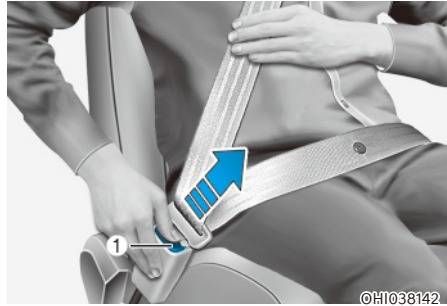

To release your seat belt:

Press the release button (1) in the locking buckle.

When it is released, the belt should automatically draw back into the retractor. If this does not happen, check the belt to be sure it is not twisted, then try again.

Rear center seatbelt (3-point rear center seat belt)

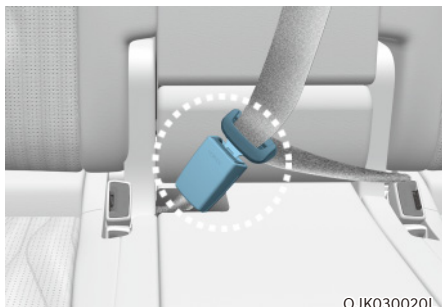

When using the rear center seat belt, the buckle with the “CENTER” mark must be used.

i Information

If you are not able to pull out the safety belt from the retractor, firmly pull the belt out and release it. After release, you will be able to pull the belt out smoothly.

! WARNING

Make sure that the seatback is locked in place when using the rear center seat belt.

If not, the seatback may move when there is a sudden stop or collision, which could result in serious injury.

Pre-tensioner seat belt



[1] : Retractor pre-tensioner seat belt
Front seat and rear outboard seat (if equipped)

Your vehicle is equipped with driver's and front passenger's and rear passengers Pre-tensioner Seat Belts (Retractor Pre-tensioner). The purpose of the pre-tensioner is to make sure the seat belts fit tightly against the occupant's body in certain frontal or side collision(s). The pre-tensioner seat belts may be activated in crashes where the frontal or side collision(s) is severe enough, together with the air bags.

When the vehicle stops suddenly, or if the occupant tries to lean forward too quickly, the seat belt retractor will lock into position.

In certain frontal collisions, the pre-tensioner will activate and pull the seat belt into tighter contact against the occupant's body.

If the system senses excessive tension on the driver or passenger's seat belt when the pre-tensioner system activates, the load limiter inside the retractor pre-tensioner will release some of the pressure on the affected seat belt (if equipped with load limiter).

⚠ WARNING

- Always wear your seat belt and sit properly in your seat.
- Do not use the seat belt if it is loose or twisted. A loose or twisted seat belt will not protect you properly in an accident.
- Do not place anything near the buckle. This may adversely affect the buckle and cause it to function improperly.
- Always replace your pre-tensioners after activation or an accident.
- NEVER inspect, service, repair or replace the pre-tensioners yourself. We recommend that you have the pre-tensioners inspected, serviced, repaired or replaced by an authorized retailer of Genesis Branded products.
- Do not hit the seat belt assemblies.

⚠ WARNING

Do not touch the pre-tensioner seat belt assemblies for several minutes after they have been activated. When the pre-tensioner seat belt mechanism deploys during a collision, the pre-tensioner can become hot and can burn you.

⚠ CAUTION

Body work on the front area of the vehicle may damage the pre-tensioner seat belt system. Therefore, we recommend the system to be serviced by an authorized retailer of Genesis Branded products.

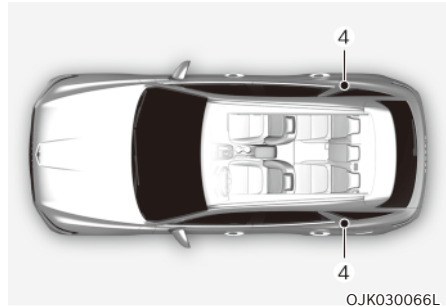
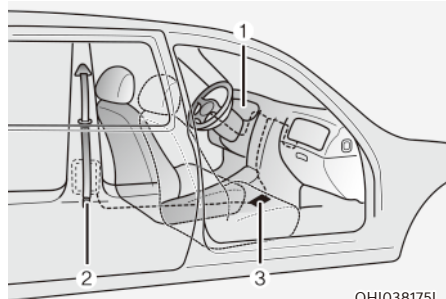

The Pre-Tensioner Seat Belt System consists mainly of the following components. Their locations are shown in the illustration above:

- (1) SRS air bag warning light
- (2) Retractor pre-tensioner
- (3) SRS control module
- (4) Rear Retractor pre-tensioner (if equipped)

NOTICE

The sensor that activates the SRS control module is connected with the pre-tensioner seat belts. The SRS air bag warning light on the instrument cluster will illuminate for approximately 3~6 seconds after the Engine Start/Stop button is in the ON position, and then it should turn off.

If the pre-tensioner is not working properly, the warning light will illuminate even if the SRS air bag is not malfunctioning. If the warning light does not illuminate, stays illuminated or illuminates when the vehicle is being driven, we recommend the pre-tensioner seat belts and/or SRS control module be inspected by an authorized retailer of Genesis Branded products as soon as possible.

i Information

- Pre-tensioner seat belts may be activated in certain frontal or side collisions or rollover situations (if equipped with rollover sensor).
- When the pre-tensioner seat belts are activated, a loud noise may be heard and fine dust, which may appear to be smoke, may be visible in the passenger compartment. These are normal operating conditions and are not hazardous.
- Although it is non-toxic, the fine dust may cause skin irritation and should not be inhaled for prolonged periods. Wash all exposed skin areas thoroughly after an accident in which the pre-tensioner seat belts were activated.

Pre-Active Seat Belt (PSB) (if equipped)

The purpose of the Pre-Active Seat Belt is to tighten the seat belt when a collision is sensed, during emergency braking, or when a loss of control is sensed.

NOTICE

Pre-Active Seat Belt is a supplementary system. Pre-Active Seat Belt activates only when the passenger is wearing his/her seat belt.

Pre-Active Seat Belt operation

In order to maximize the safety of the passenger, Pre-Active Seat Belt system operates as below.

- Full retraction
 - The seat belt is tightened when:
 - Emergency braking situation occurs
 - Losing control of the vehicle
 - The vehicle detects a collision
 - Driving on a frozen road
 - Driving on a rough road with severe impact
 - Unstable rolling of the vehicle occurs
- Slack removal
 - Tightens a loose seat belt if vehicle speed is over 15 km/h (9 mph).
- Belt parking
 - Tightens a loose seat belt when the seat belt is unfastened.

Warning message



Check Pre-Active Seat Belt

The Pre-Active Seat Belt warning message will appear if there is a problem with your Pre-Active Seat Belt.

We recommend that the system be inspected by an authorized retailer of Genesis Branded products if the warning message comes on while the vehicle is in motion. When the Pre-Active Seat Belt warning message disappears, the master warning light (⚠️) will illuminate.

Additional seat belt safety precautions

Seat belt use during pregnancy

The seat belt should always be used during pregnancy. The best way to protect your unborn child is to protect yourself by always wearing the seat belt.

Pregnant women should always wear a lap-shoulder seat belt. Place the shoulder belt across your chest, routed between your breasts and away from your neck. Place the lap belt below your belly so that it fits **SNUGLY** across your hips and pelvic bone, under the rounded part of the belly.



WARNING

To reduce the risk of serious injury or death to an unborn child during an accident, pregnant women should NEVER place the lap portion of the seat belt above or over the area of the abdomen where the unborn child is located.

Seat belt use and children

Infant and small children

Most countries have Child Restraint System laws which require children to travel in approved Child Restraint System devices, including booster seats. The age at which seat belts can be used instead of Child Restraint System differs among countries, so you should be aware of the specific requirements in your country, and where you are travelling. Infant and Child Restraint System must be properly placed and installed in a rear seat.

For more information refer to the “Child Restraint Systems” section in this chapter.

**WARNING**

ALWAYS properly restrain infants and small children in a Child Restraint System appropriate for the child's height and weight.

To reduce the risk of serious injury or death to a child and other passengers, NEVER hold a child in your lap or arms when the vehicle is moving. The violent forces created during an accident will tear the child from your arms and throw the child against the interior of the vehicle.

Small children are best protected from injury in an accident when properly restrained in the rear seat by a Child Restraint System that meets the requirements of the Safety Standards of your country. Before buying any Child Restraint System, make sure that it has a label certifying that it meets Safety Standard of your country.

The Child Restraint System must be appropriate for your child's height and weight. Check the label on the Child Restraint System for this information. Refer to "Child Restraint Systems" section in this chapter.

Larger children

Children under age 13 and who are too large for a booster seat should always occupy the rear seat and use the available lap/shoulder belts. A seat belt should lie across the upper thighs and be snug across the shoulder and chest to restrain the child safely. Check belt fit periodically. A child's squirming could put the belt out of position. In the event of an accident, children are afforded the best safety restrained by a proper Child Restraint System in the rear seats.

If a larger child over age 13 must be seated in the front seat, the child must be securely restrained by the available lap/shoulder belt and the seat should be placed in the rearmost position.

If the shoulder belt portion slightly touches the child's neck or face, try placing the child closer to the center of the vehicle. If the shoulder belt still touches their face or neck, they need to be returned to an appropriate booster seat in the rear seat.

**WARNING**

- **Always make sure larger children's seat belts are worn and properly adjusted.**
- **NEVER allow the shoulder belt to contact the child's neck or face.**
- **Do not allow more than one child to use a single seat belt.**

Seat belt use and injured people

A seat belt should be used when an injured person is being transported. Consult a physician for specific recommendations.

One person per belt

Two people (including children) should never attempt to use a single seat belt. This could increase the severity of injuries in case of an accident.

Do not lie down

Sitting in a reclined position when the vehicle is in motion can be dangerous. Even when buckled up, the protections of your restraint system (seat belts and/or air bags) is greatly reduced by reclining your seatback.

Seat belts must be snug against your hips and chest to work properly.

During an accident, you could be thrown into the seat belt, causing neck or other injuries.

The more the seat back is reclined, the greater the chance for the passenger's hips to slide under the lap belt or the passenger's neck to strike the shoulder belt.



WARNING

- **NEVER ride with a reclined seatback when the vehicle is moving.**
- **Riding with a reclined seatback increases your chance of serious or fatal injuries in the event of a collision or sudden stop.**
- **Driver and passengers should always sit well back in their seats, properly belted, and with the seatbacks upright.**

Care of seat belts

Seat belt systems should never be disassembled or modified. In addition, care should be taken to assure that seat belts and belt hardware are not damaged by seat hinges, doors or other abuse.

Periodic inspection

All seat belts should be inspected periodically for wear or damage of any kind. Any damaged parts should be replaced as soon as possible.

Keep belts clean and dry

Seat belts should be kept clean and dry. If belts become dirty, they can be cleaned by using a mild soap solution and warm water. Bleach, dye, strong detergents or abrasives should not be used because they may damage and weaken the fabric.

When to replace seat belts

The entire seat belt assembly or assemblies should be replaced if the vehicle has been involved in an accident. This should be done even if no damage is visible. We recommend that you consult an authorized retailer of Genesis Branded products.

CHILD RESTRAINT SYSTEM (CRS)

Our recommendation: Children always in the rear



WARNING

Always properly restrain children in the vehicle. Children of all ages are safer when riding in the rear seats. Never place a rearward-facing Child Restraint System on the front passenger seat, unless the air bag is deactivated.

Children under age 13 should always ride in the rear seats and must always be properly restrained to minimize the risk of injury in an accident, sudden stop or sudden maneuver.

According to accident statistics, children are safer when properly restrained in the rear seats than in the front seat. Children too large for a Child Restraint System must use the seat belts provided.

Most countries have regulations which require children to travel in approved Child Restraint Systems.

The laws governing the age or height/weight restrictions at which seat belts can be used instead of Child Restraint System differs among countries, so you should be aware of the specific requirements in your country, and where you are travelling.

Child Restraint Systems must be properly installed in the vehicle seat. Always use a commercially available Child Restraint System that meets the requirements of your country.

Child Restraint System (CRS)

Infants and younger children must be restrained in an appropriate rearward-facing or forward-facing CRS that has first been properly secured to the seat of the vehicle. Read and comply with the instructions for installation and use provided by the manufacturer of the Child Restraint System.



WARNING

- **Always follow the Child Restraint System manufacturer's instructions for installation and use.**
- **Always properly restrain your child in the Child Restraint System.**
- **Do not use an infant carrier or a child safety seat that "hooks" over a seatback, it may not provide adequate protection in an accident.**
- **After an accident, we recommend a retailer of Genesis Branded products to check the Child Restraint System, seat belts, ISOFIX anchorages and top-tether anchorages.**

Selecting a Child Restraint System (CRS)

When selecting a Child Restraint System for your child, always:

- Make sure the Child Restraint System has a label certifying that it meets applicable Safety Standards of your country.

A Child Restraint System may only be installed if it was approved in accordance with the requirements of ECE-R44 or ECE-R129.

- Select a Child Restraint System based on your child's height and weight. The required label or the instructions for use typically provide this information.
- Select a Child Restraint System that fits the vehicle seating position where it will be used.
- Read and comply with the warnings and instructions for installation and use provided with the Child Restraint System.

Child Restraint System types

There are three main types of Child Restraint Systems: rearward-facing, forward-facing and booster Child Restraint Systems.

They are classified according to the child's age, height and weight.

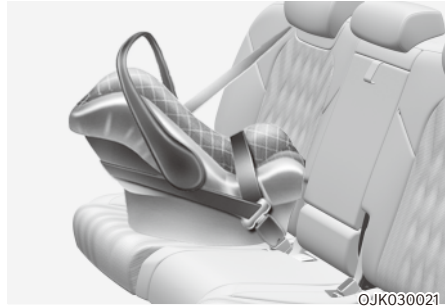

Rearward-facing Child Restraint System

A rearward-facing Child Restraint System provides restraint with the seating surface against the back of the child. The harness system holds the child in place, and in an accident, acts to keep the child positioned in the Child Restraint Systems and reduce the stress to the fragile neck and spinal cord.

All children under the age of one year must always ride in a rearward-facing Child Restraint System. There are different types of rearward-facing Child Restraint Systems: infant-only Child Restraint Systems can only be used rearward-facing. Convertible and 3-in-1 Child Restraint Systems typically have higher height and weight limits for the rearward-facing position, allowing you to keep your child rearward-facing for a longer period of time.

Keep using Child Restraint Systems in the rearward-facing position as long as children fit within the height and weight limits allowed by the Child Restraint System's manufacturer.



Forward-facing Child Restraint System

A forward-facing Child Restraint System provides restraint for the child's body with a harness. Keep children in a forward-facing Child Restraint System with a harness until they reach the top height or weight limit allowed by your Child Restraint System's manufacturer.

Once your child outgrows the forward-facing Child Restraint System, your child is ready for a booster seat.

Booster seats

A booster seat is a Child Restraint System designed to improve the fit of the vehicle's seat belt system. A booster seat positions the seat belt so that it fits properly over the stronger parts of your child's body. Keep your children in booster seats until they are big enough to fit in a seat belt properly.

For a seat belt to fit properly, the lap belt must lie comfortable across the upper thighs, not the stomach. The shoulder belt should lie comfortable across the shoulder and chest and not across the neck or face. Children under age 13 must always be properly restrained to minimize the risk of injury in an accident, sudden stop or sudden maneuver.

Installing a Child Restraint System (CRS)



WARNING

Before installing your Child Restraint System always:

Read and follow the instructions provided by the manufacturer of the Child Restraint System.

Failure to follow all warnings and instructions could increase the risk of the SERIOUS INJURY or DEATH if an accident occurs.



WARNING

If the vehicle headrest prevents proper installation of a Child Restraint System, the headrest of the respective seating position shall be readjusted or entirely removed.

After selecting a proper Child Restraint System for your child and checking that the Child Restraint System fits properly on the seating position, there are three general steps for a proper installation:

- **Properly secure the Child Restraint System to the vehicle.** All Child Restraint Systems must be secured to the vehicle with the lap belt or lap part of a lap/shoulder belt or with the ISOFIX top-tether and/or ISOFIX anchorage and/or with the support leg.

- **Make sure the Child Restraint System is firmly secured.** After installing a Child Restraint System to the vehicle, push and pull the seat forward and from side-to-side to verify that it is securely attached to the seat. A Child Restraint System secured with a seat belt should be installed as firmly as possible. However, some side-to-side movement can be expected.

When installing a Child Restraint System, adjust the vehicle seat and seatback (up and down, forward and rearward) so that your child fits in the Child Restraint System in a comfortable manner.

- **Secure the child in the Child Restraint System.** Make sure the child is properly strapped in the Child Restraint System according to the Child Restraint System manufacturer's instructions.



CAUTION

A Child Restraint System in a closed vehicle can become very hot. To prevent burns, check the seating surface and buckles before placing your child in the Child Restraint System.

Suitability of each seating position for belted & ISOFIX Child Restraint Systems according to UN regulations (for Europe)

(Information for vehicle users and CRS manufacturers)

- Yes : Suitable for fitment of the designated category of CRS
- No : Not suitable for fitment of the designated category of CRS
- “-” : Not applicable
- The table is based on left-hand drive vehicle. Except for the front passenger seat, the table is valid for right-hand drive vehicle. For right-hand drive vehicle front passenger seat, please use information for the seating position number 3.

CRS categories		Seating positions					
		1,2	3		4	5	6
			Airbag ON	Airbag OFF			
Universal belted CRS	All mass groups	-	No	Yes ¹⁾ (F, R)	Yes ²⁾ (F, R)	Yes ³⁾ (F, R)	Yes ²⁾ (F, R)
i-size CRS	ISOFIX CRF : F2, F2X, R1, R2	-	No	No	Yes (F, R)	No	Yes (F, R)
Carry-cot (ISOFIX lateral facing CRS)	ISOFIX CRF: L1, L2	-	No	No	No	No	No
ISOFIX infant* CRS (* : ISOFIX baby CRS)	ISOFIX CRF : R1	-	No	No	Yes (R)	No	Yes (R)
ISOFIX toddler CRS - small	ISOFIX CRF : F2, F2X, R2, R2X	-	No	No	Yes (F, R)	No	Yes (F, R)
ISOFIX toddler CRS - large* (* : not booster seats)	ISOFIX CRF : F3,R3	-	No	No	Yes (F, R)	No	Yes (F, R)
Booster Seat - reduced Width	ISO CRF : B2	-	Yes	No	Yes	No	Yes
Booster Seat - full Width	ISO CRF : B3	-	Yes	No	Yes	No	Yes

* **F** : Forward facing, **R** : Rearward facing

Note¹⁾ : To install Universal CRS, 1st row passenger seat height should be at its highest position.

Note²⁾ : To install Universal CRS to 2nd row outer seating positions, 1st row seat should be adjust forward properly.

Note³⁾ : Never install CRS with a support leg on 2nd row center seating position.

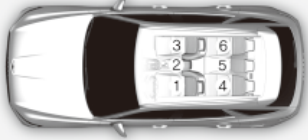
Seat number	Position in the vehicle	Seating positions
1	Front left	
2	Front center	
3	Front right	
4	Second row left	
5	Second row center	
6	Second row right	

OJK030067L

- * If the vehicle headrest prevents proper installation of a CRS, the headrest of the seating position shall be readjusted or entirely removed.
- * Never place a rearward facing Child Restraint System on the front passenger seat, unless the air bag is deactivated.

Recommended CRS for Vehicle according to UN regulations

(Information for use by vehicle users and CRS manufacturers)

Mass group	Name	Manufacturer	Type of Fixation	ECE Approval Number
Group 0+	BABY-SAFE 2 i-SIZE and BABY-SAFE i-SIZE BASE	Britax Römer	ISOFIX with support leg rearward facing	R129/00 - E1 - 000008
Group I	Duo Plus	Britax Römer	ISOFIX and top-tether	R44/04 - E1 - 04301133
Group II	KidFix II R	Britax Römer	ISOFIX and vehicle belt, using CRS lap belt guide	R44/04 - E1 - 04301304
Group III	Junior III	Graco	Vehicle belt	R44/04 - E11 - 03.44.165

CRS Manufacturer information

Britax Römer <http://www.britax.com>

Graco : <http://www.gracobaby.com>

Suitability of each seating position for belted & ISOFIX Child Restraint Systems according to UN regulations (except Europe)

(Information for vehicle users and CRS manufacturers)

- Yes : Suitable for fitment of the designated category of CRS
- No : Not suitable for fitment of the designated category of CRS
- “-” : Not applicable
- The table is based on left-hand drive vehicle. Except for the front passenger seat, the table is valid for right-hand drive vehicle. For right-hand drive vehicle front passenger seat, please use information for the seating position number 3.

CRS categories		Seating positions					
		1,2	3		4	5	6
			Airbag ON	Airbag OFF			
Universal belted CRS	All mass groups	-	No	Yes ¹⁾ (F)	Yes ²⁾ (F, R)	Yes ³⁾ (F, R)	Yes ²⁾ (F, R)
i-size CRS	ISOFIX CRF : F2, F2X, R1, R2	-	No	No	No	No	No
Carry-cot (ISOFIX lateral facing CRS)	ISOFIX CRF: L1, L2	-	No	No	No	No	No
ISOFIX infant* CRS (* : ISOFIX baby CRS)	ISOFIX CRF : R1	-	No	No	Yes (R)	No	Yes (R)
ISOFIX toddler CRS - small	ISOFIX CRF : F2, F2X, R2, R2X	-	No	No	Yes (F, R)	No	Yes (F, R)
ISOFIX toddler CRS - large* (* : not booster seats)	ISOFIX CRF : F3, R3	-	No	No	Yes (F, R)	No	Yes (F, R)
Booster Seat - reduced Width	ISO CRF : B2	-	Yes	No	Yes	No	Yes
Booster Seat - full Width	ISO CRF : B3	-	Yes	No	Yes	No	Yes

* **F** : Forward facing, **R** : Rearward facing

Note¹⁾ : To install Universal CRS, 1st row passenger seat height should be at its highest position.

Note²⁾ : To install Universal CRS to 2nd row outer seating positions, 1st row seat should be adjust forward properly.

Note³⁾ : Never install CRS with a support leg on 2nd row center seating position.

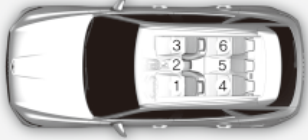
Seat number	Position in the vehicle	Seating positions
1	Front left	
2	Front center	
3	Front right	
4	Second row left	
5	Second row center	
6	Second row right	

OJK030067L

- * If the vehicle headrest prevents proper installation of a CRS, the headrest of the seating position shall be readjusted or entirely removed.
- * Never place a rearward facing Child Restraint System on the front passenger seat, unless the air bag is deactivated.

ISOFIX anchorage and top-tether anchorage (ISOFIX anchorage system) for children

The ISOFIX system holds a Child Restraint System during driving and in an accident. This system is designed to make installation of the Child Restraint System easier and reduce the possibility of improperly installing your Child Restraint System. The ISOFIX system uses anchors in the vehicle and attachments on the Child Restraint System. The ISOFIX system eliminates the need to use seat belts to secure the Child Restraint System to the rear seats. ISOFIX anchorages are metal bars built into the vehicle. There are two lower anchors for each ISOFIX seating position that will accommodate a Child Restraint System with lower attachments.

To use the ISOFIX system in your vehicle, you must have a Child Restraint System with ISOFIX attachments.

The Child Restraint System manufacturer will provide you with instructions on how to use the Child Restraint System with its attachments for the ISOFIX anchorages.

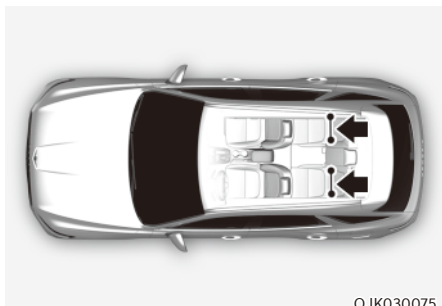



ISOFIX anchorages have been provided in the left and right outboard rear seating positions. Their locations are shown in the illustration.

⚠ WARNING

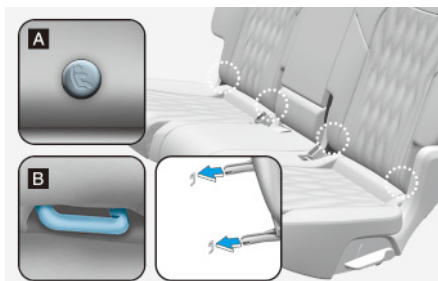
Do not attempt to install a Child Restraint System using ISOFIX anchorages in the rear center seating position. There are no ISOFIX anchorages provided for this seat. Using the outboard seat anchorages, for the CRS installation on the rear center seating position, can damage the anchorages.



[A] : ISOFIX Anchorage Position Indicator
(Type A- , Type B- )
[B] : ISOFIX Anchorage

ISOFIX anchorages are located between the seatback and the seat cushion of the rear seat left and right outboard seating positions, indicated by the symbols.

Securing a Child Restraint System with the “ISOFIX Anchorage System”

To install an i-Size or ISOFIX-compatible Child Restraint System in either of the rear outboard seating positions:

1. Move the seat belt buckle away from the ISOFIX anchorages.
2. Move any other objects away from the anchorages that could prevent a secure connection between the Child Restraint System and the ISOFIX anchorages.

- Place the Child Restraint System on the vehicle seat, then attach the seat to the ISOFIX anchorages according to the instructions provided by the Child Restraint System manufacturer.
- Follow the instructions of the Child Restraint System's manufacturer for proper installation and connection of the ISOFIX attachments on the Child Restraint System to the ISOFIX anchorages.



WARNING

Take the following precautions when using the ISOFIX system:

- **Read and follow all installation instructions provided with your Child Restraint System.**
- **To prevent the child from reaching and taking hold of unretracted seat belts, buckle all unused rear seat belts and retract the seat belt webbing behind the child. Children can be strangled if a shoulder belt becomes wrapped around their neck and the seat belt tightens.**
- **NEVER attach more than one Child Restraint System to a single anchorage. This could cause the anchor or attachment to come loose or break.**
- **Always have the ISOFIX system inspected by your dealer after an accident. An accident can damage the ISOFIX system and may not properly secure the Child Restraint System.**

Securing a Child Restraint System seat with "Top-tether Anchorage" system

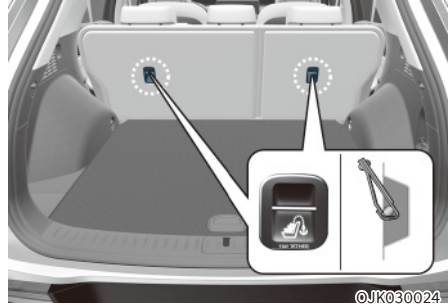

Top-tether anchorages for Child Restraint Systems are located on the rear of the seatbacks.



1. Route the Child Restraint System top-tether strap over the seatback. Placing the top tether strap, please follow the instructions of the Child Restraint System manufacturer.
2. Connect the top-tether strap to the top-tether anchorage, then tighten the top-tether strap according to the instructions of your Child Restraint System's manufacturer to firmly attach the Child Restraint System to the seat.



WARNING

Take the following precautions when installing the top-tether:

- Read and follow all installation instructions provided with your Child Restraint System.
- NEVER attach more than one Child Restraint System to a single ISOFIX top-tether anchorage. This could cause the anchorage or attachment to come loose or break.
- Do not attach the top-tether to anything other than the correct top-tether anchorage. It may not work properly if attached to something else.
- Child Restraint System anchorages are designed to withstand only those loads imposed by correctly fitted Child Restraint System. Under no circumstances are they to be used for adult seat belts or harnesses or for attaching other items or equipment to the vehicle.

Securing a Child Restraint System with a lap/shoulder belt

When not using the ISOFIX system, all Child Restraint Systems must be secured to a rear seat with the lap part of a lap/shoulder belt.

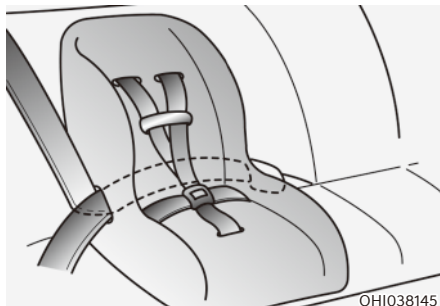

Installing a Child Restraint System with a lap/shoulder belt

To install a Child Restraint System on the rear seats, do the following:

1. Place the Child Restraint System on a rear seat and route the lap/shoulder belt around or through the Child Restraint System, following the Child Restraint System manufacturer's instructions. Make sure the seat belt webbing is not twisted.

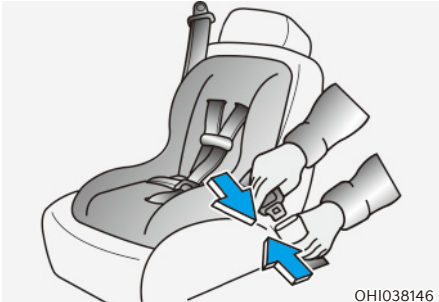

2. Fasten the lap/shoulder belt latch into the buckle. Listen for the distinct “click” sound.

i Information

Position the release button so that it is easy to access in case of an emergency.



3. Remove as much slack from the belt as possible by pushing down on the Child Restraint System while feeding the shoulder belt back into the retractor.
4. Push and pull on the Child Restraint System to confirm that the seat belt is holding it firmly in place.

If your Child Restraint System manufacturer recommends the use of a top-tether with the lap/shoulder belt, see page 3-48.

To remove the Child Restraint System, press the release button on the buckle and then pull the lap/shoulder belt out of the Child Restraint System and allow the seat belt to retract fully.

⚠ WARNING

If a child restraint is installed in the second row center seat, move the second row seat far back as possible, to minimize contact with the front center air bag (if equipped with front center air bag).

AIR BAG - SUPPLEMENTAL RESTRAINT SYSTEM

■ Left-hand drive

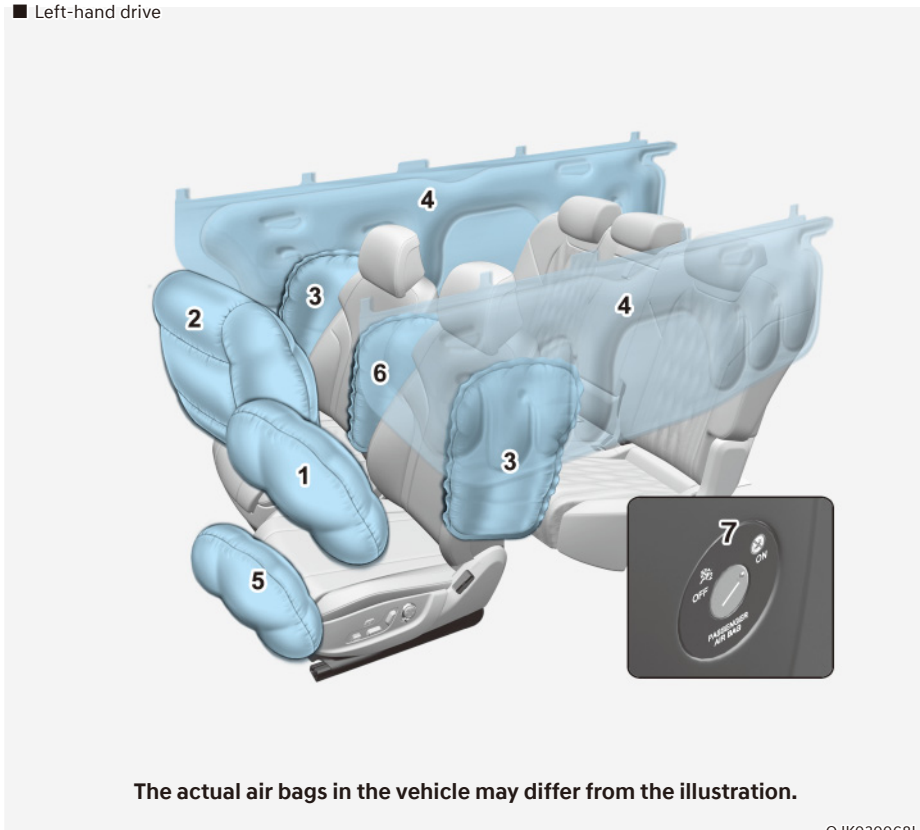

The actual air bags in the vehicle may differ from the illustration.

OJK030068L

1. Driver's front air bag
2. Passenger's front air bag
3. Side air bag
4. Curtain air bag
5. Driver's knee air bag
6. Front center air bag
7. Front passenger air bag ON/OFF switch*

* : if equipped

■ Right-hand drive

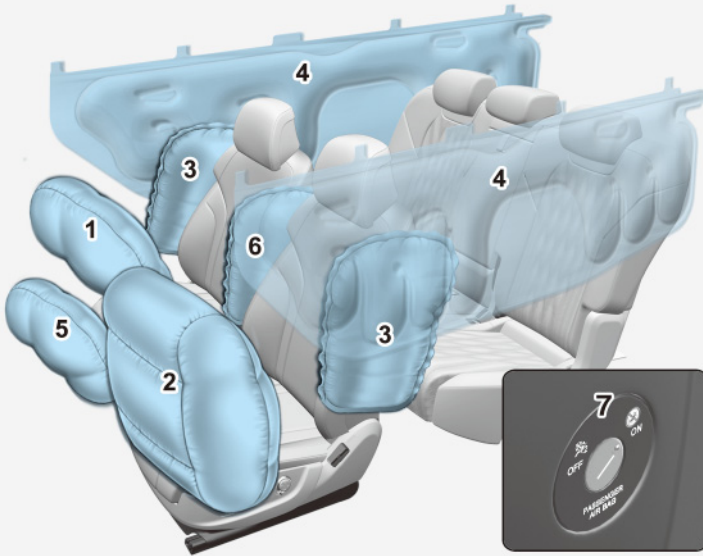

The actual air bags in the vehicle may differ from the illustration.

OJK030068R

- 1. Driver's front air bag
- 2. Passenger's front air bag
- 3. Side air bag
- 4. Curtain air bag
- 5. Driver's knee air bag
- 6. Front center air bag
- 7. Front passenger air bag ON/OFF switch (if equipped)

The vehicles are equipped with a Supplemental Air Bag System for the driver's seat and front passenger's seats.

The front air bags are designed to supplement the three-point seat belts. For these air bags to provide protection, the seat belts must be worn at all times when driving.

You can be severely injured or killed in an accident if you are not wearing a seat belt. Air bags are designed to supplement seat belts, but do not replace them. Also, air bags are not designed to deploy in every collision. In some accidents, the seat belts are the only restraint protecting you.



WARNING

AIR BAG SAFETY PRECAUTIONS

ALWAYS use seat belts and Child Restraint Systems - every trip, every time, everyone! Even with air bags, you can be seriously injured or killed in a collision if you are improperly belted or not wearing your seat belt when the air bag inflates.

NEVER place a child in any Child Restraint System or booster seat in the front passenger seat, unless the air bag is deactivated.

An inflating air bag could forcefully strike the infant or child causing serious or fatal injuries.

ABC - Always Buckle Children under age 13 in the back seat. It is the safest place for children of any age to ride. If a child age 13 or older must be seated in the front seat, he or she must be properly belted and the seat should be moved as far back as possible.

All occupants should sit upright with the seatback in an upright position, centered on the seat cushion with their seat belt on, legs comfortably extended and their feet on the floor until the vehicle is parked and the vehicle is turned off. If an occupant is out of position during an accident, the rapidly deploying air bag may forcefully contact the occupant causing serious or fatal injuries.

You and your passengers should never sit or lean unnecessarily close to the air bags or lean against the door or center console.

Move your seat as far back as possible from front air bags, while still maintaining control of the vehicle.

Where are the air bags?

Driver's and passenger's front air bags



Your vehicle is equipped with a Supplemental Restraint System (SRS) and lap/shoulder belts at both the driver and passenger seating positions.

The SRS consists of air bags which are located in the center of the steering wheel, in the driver's side lower crash pad below the steering wheel, and the passenger's side front panel pad above the glove box.

The air bags are labeled with the letters "AIR BAG" embossed on the pad covers.

The purpose of the SRS is to provide the vehicle's driver and front passengers with additional protection than that offered by the seat belt system alone in case of a frontal impact of sufficient severity.

WARNING

To reduce the risk of serious injury or death from inflating front air bags, take the following precautions:

- Seat belts must be worn at all times to help keep occupants positioned properly.
- Move your seat as far back as possible from front air bags, while still maintaining control of the vehicle.
- Never lean against the door or center console.
- Do not allow the front passenger to place their feet or legs on the dashboard.
- No objects (such as crash pad cover, mobile phone holder, cup holder, perfume or stickers) should be placed over or near the air bag modules on the steering wheel, instrument panel, windshield glass, and the front passenger's panel above the glove box. Such objects could cause harm if the vehicle is in a crash severe enough to cause the air bags to deploy.
- Do not attach any objects on the front windshield and inside mirror.



©JX1039126L

Passenger's front air bag ON/OFF switch (if equipped)

The purpose of the switch is to disable the passenger's front air bag in order to transport occupants who are at increased risk for air bag-related injury due to age, size, or medical condition.

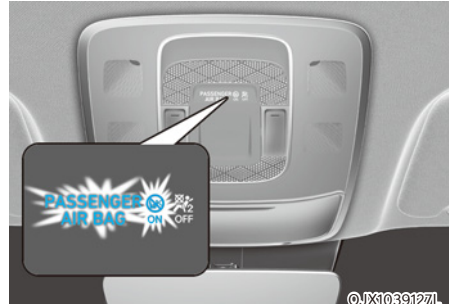

©JX1039127L

To reactivate the passenger's front air bag:

Insert the key or a similar rigid device into the passenger's front air bag ON/OFF switch and turn it to the ON position. The passenger air bag ON indicator (ⓧ) will illuminate.



©JX1039068L

To deactivate the passenger's front air bag:

Insert the key or a similar rigid device into the passenger's front air bag ON/OFF switch and turn it to the OFF position. The passenger air bag OFF indicator (ⓧ) will illuminate and stay on until the passenger's front air bag is reactivated.

i Information

The passenger's front air bag ON/OFF indicator generally illuminates for about 4 seconds after the Engine Start/Stop button is in the ON position. But, if the Engine Start/Stop button is pressed to the ON position within 3 minutes after the engine was turned off, the indicator will not illuminate.

⚠ WARNING

Never allow an adult passenger to ride in the front passenger seat when the passenger air bag OFF indicator is illuminated. During a collision, the air bag will not inflate if the indicator is illuminated. Turn on the passenger's front air bag or have your passenger move to the rear seat.

⚠ WARNING

If the passenger's front air bag ON/OFF switch malfunctions, the following conditions may occur:

- The air bag warning light (🚨) on the instrument cluster will illuminate.
- The passenger air bag OFF indicator (🚫) will not illuminate and the ON indicator (🚗) will come on. The passenger's front air bag will inflate in a frontal impact even though the passenger's front air bag ON/OFF switch is set to the OFF position.
- We recommend that an authorized retailer of Genesis Branded products inspect the passenger's front air bag ON/OFF switch and the SRS air bag system as soon as possible.

Side air bags and front center air bag (if equipped)

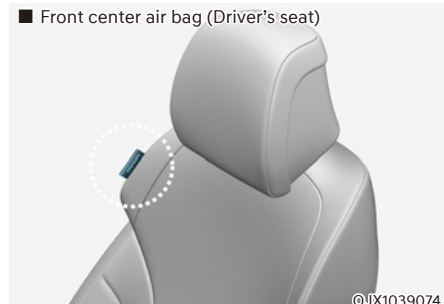
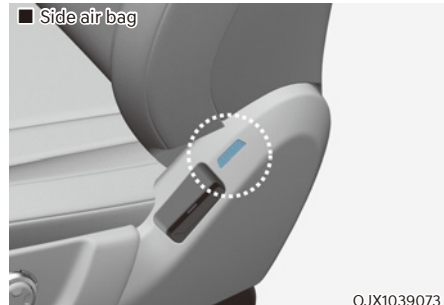

Your vehicle is equipped with a side air bag in each front seat. Additionally, a front center air bag is provided in the inboard side of the driver seatback. The purpose of the air bag is to provide the vehicle's additional protection than that offered by the seat belt alone.

The side air bags and front center air bag are designed to deploy during certain side impact collisions, depending on the crash severity.

For vehicles equipped with a rollover sensor the front center air bag, side and/or curtain air bags and pre-tensioners on both sides of the vehicle may deploy if a rollover or possible rollover is detected.

The side air bags and front center air bag are not designed to deploy in all side impact or rollover situations.



WARNING

To reduce the risk of serious injury or death from an inflating side air bag and front center air bag, take the following precautions:

- **Seat belts must be worn at all times to help keep occupants positioned properly.**
- **Do not allow passengers to lean their heads or bodies onto doors, put their arms on the doors, stretch their arms out of the window, or place objects between the doors and seats.**
- **Hold the steering wheel at the 9 o'clock and 3 o'clock positions, to minimize the risk of injuries to your hands and arms.**
- **Do not use any accessory seat covers. This could reduce or prevent the effectiveness of the system.**
- **Do not hang other objects except clothes. In an accident it may cause vehicle damage or personal injury especially when air bag is inflated.**
- **Do not place any objects over the air bag or between the air bag and yourself. Also, do not attach any objects around the area the air bag inflates such as the door, side door glass, front and rear pillar.**
- **Do not place any objects between the door and the seat. They may become dangerous projectiles if the side air bag inflates.**
- **Do not install any accessories on the side or near the side air bags.**
- **Do not cause impact to the doors when the Engine Start/Stop button is in the ON or START position as this may cause the side air bags to inflate.**
- **If the seat or seat cover is damaged, we recommend that the system be serviced by an authorized retailer of Genesis Branded products.**

Curtain air bags



Curtain air bags are located along both sides of the roof rails above the front and rear doors.

They are designed to help protect the heads of the front seat occupants and the rear outboard seat occupants in certain side impact collisions.

The curtain air bags are designed to deploy during certain side impact collisions, depending on the crash severity.

For vehicles equipped with a rollover sensor the side and/or curtain air bags and pre-tensioners on both sides of the vehicle may deploy if a rollover or possible rollover is detected.

The curtain air bags are not designed to deploy in all side impact or rollover situations.

WARNING

To reduce the risk of serious injury or death from an inflating curtain air bag, take the following precautions:

- All seat occupants must wear seat belts at all times to help keep occupants positioned properly.
- Properly secure Child Restraint System as far away from the door as possible.
- Do not place any objects over the air bag. Also, do not attach any objects around the area the air bag inflates such as the door, side door glass, front and rear pillar, roof side rail.
- Do not hang other objects except clothes, especially hard or breakable objects.
In an accident, it may cause vehicle damage or personal injury.
- Do not allow passengers to lean their heads or bodies onto doors, put their arms on the doors, stretch their arms out of the window, or place objects between the doors and seats.
- Do not open or repair the side curtain air bags.

How does the air bags system operate?

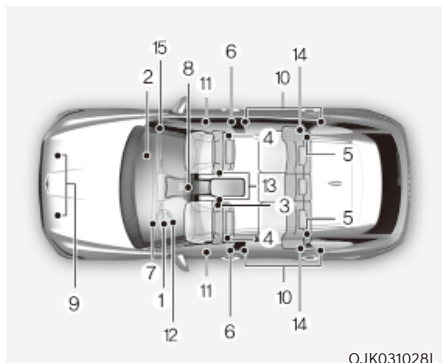

OJK031028L

The SRS consists of the following components:

- (1) Driver's front air bag module
- (2) Passenger's front air bag module
- (3) Front center air bag module (if equipped)
- (4) Side air bag modules
- (5) Curtain air bag modules
- (6) Front retractor pre-tensioner
- (7) Air bag warning light
- (8) SRS control module (SRSCM) / Rollover sensor (if equipped)
- (9) Front impact sensors
- (10) Side impact sensors (acceleration)
- (11) Side impact sensors (pressure)
- (12) Driver's knee air bag module
- (13) Driver's and front passenger's seat belt buckle sensors
- (14) Rear retractor pre-tensioner (if equipped)
- (15) Front passenger's air bag ON/OFF switch (if equipped)

Information

Front passenger's air bag ON/OFF lamp is located on the overhead console.

The SRSCM (Supplemental Restraint System Control Module) continually monitors all SRS components while the Engine Start/Stop button is ON to determine if a crash impact is severe enough to require air bag deployment or pre-tensioner seat belt deployment.



SRS warning light

The SRS (Supplemental Restraint System) air bag warning light on the instrument panel displays the air bag symbol depicted in the illustration. The system checks the air bag electrical system for malfunctions. The light indicates that there is a potential problem with your air bag system, which could include your side and/or curtain air bags used for rollover protection (if equipped with rollover sensor).



WARNING

If your SRS malfunctions, the air bag may not inflate properly during an accident increasing the risk of serious injury or death.

If any of the following conditions occur, your SRS is malfunctioning:

- **The light does not turn on for approximately three to six seconds when the Engine Start/Stop button is in the ON position.**
- **The light stays on after illuminating for approximately three to six seconds.**
- **The light comes on while the vehicle is in motion.**
- **The light blinks when the engine is running.**

We recommend that an authorized retailer of Genesis Branded products inspect the SRS as soon as possible if any of these conditions occur.

During a moderate to severe frontal collision, sensors will detect the vehicle's rapid deceleration. If the rate of deceleration is high enough, the control unit will inflate the front air bags, at the time and with the force needed.

The front air bags help protect the driver and front passenger by responding to frontal impacts in which seat belts alone cannot provide adequate restraint. When needed, the side air bags help provide protection in the event of a side impact or rollover by supporting the side upper body area.

- Air bags are activated (able to inflate if necessary) only when the Engine Start/Stop button is in the ON or START position, and it can be activated within about 3 minutes after the engine is turned off.
- Air bags inflate in the event of certain frontal or side collisions to help protect the occupants from serious physical injury.
- Generally, air bags are designed to inflate based upon the severity of a collision, its direction, or etc. These two factors determine whether the sensors produce an electronic deployment/inflation signal.
- The front air bags will completely inflate and deflate in an instant. It is virtually impossible for you to see the air bags inflate during an accident. It is much more likely that you will simply see the deflated air bags hanging out of their storage compartments after the collision.

- In addition to inflating in serious side collisions, vehicles equipped with a rollover sensor, side and/or curtain air bags and front center air bag will inflate if the sensing system detects a rollover.

When a rollover is detected, curtain air bags will remain inflated longer to help provide protection from ejection, especially when used in conjunction with the seat belts. (if equipped with a rollover sensor)

- To help provide protection, the air bags must inflate rapidly. The speed of air bag inflation is a consequence of extremely short time in which to inflate the air bag between the occupant and the vehicle structures before the occupant impacts those structures. This speed of inflation reduces the risk of serious or life-threatening injuries and is thus a necessary part of air bag design. However, the rapid air bag inflation can also cause injuries which can include facial abrasions, bruises and broken bones because the inflation speed also causes the air bags to expand with a great deal of force.
- There are even circumstances under which contact with the air bag can cause fatal injuries, especially if the occupant is positioned excessively close to the air bag.

You can take steps to reduce the risk of being injured by an inflating air bag. The greatest risk is sitting too close to the air bag. An air bag needs space to inflate. It is recommended that drivers sit as far as possible between the center of the steering wheel and the chest while still maintaining control of the vehicle.

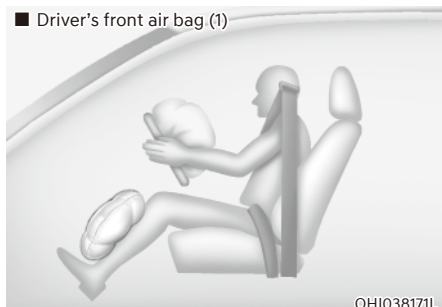

When the SRSCM detects a sufficiently severe impact to the front of the vehicle, it will automatically deploy the front air bags.

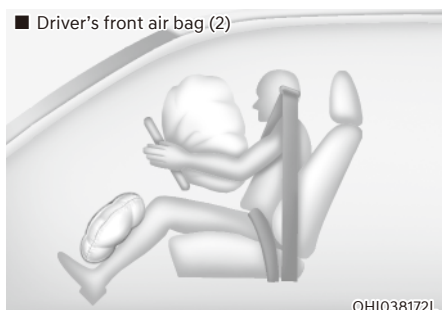

Upon deployment, tear seams molded directly into the pad covers will separate under pressure from the expansion of the air bags. Further opening of the covers allows full inflation of the air bags.

A fully inflated air bag, in combination with a properly worn seat belt, slows the driver's or the front passenger's forward motion, reducing the risk of head and chest injury.

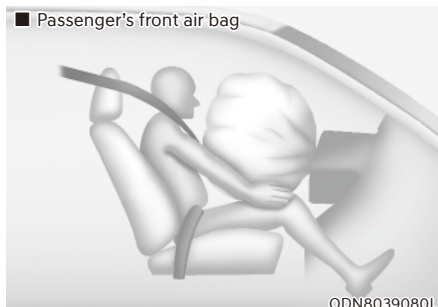
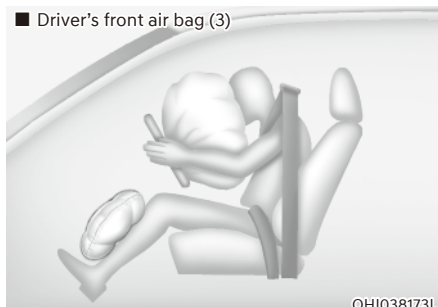

After complete inflation, the air bag immediately starts deflating, enabling the driver to maintain forward visibility and the ability to steer or operate other controls.

WARNING

To prevent objects from becoming dangerous projectiles when the passenger's air bag inflates:

- Do not install or place any objects (drink holder, CD holder, stickers, etc.) on the front passenger's panel above the glove box where the passenger's air bag is located.
- Do not install a container of liquid air freshener near the instrument cluster or on the instrument panel surface.

What to expect after an air bag inflates

After a frontal or side air bag inflates, it will deflate very quickly. Air bag inflation will not prevent the driver from seeing out of the windshield or being able to steer. Curtain air bags may remain partially inflated for some time after they deploy.



WARNING

After an air bag inflates, take the following precautions:

- **Open your windows and doors as soon as possible after impact to reduce prolonged exposure to the smoke and powder released by the inflating air bag.**
- **Do not touch the air bag storage area's internal components immediately after an air bag has inflated. The parts that come into contact with an inflating air bag may be very hot.**
- **Always wash exposed skin areas thoroughly with cold water and mild soap.**
- **We recommend that an authorized retailer of Genesis Branded products replace the air bag immediately after deployment. Air bags are designed to be used only once.**

Noise and smoke from inflating air bag

When the air bags inflate, they make a loud noise and may produce smoke and powder in the air inside of the vehicle. This is normal and is a result of the ignition of the air bag inflator. After the air bag inflates, you may feel substantial discomfort in breathing because of the contact of your chest with both the seat belt and the air bag, as well as from breathing the smoke and powder. The powder may aggravate asthma for some people. If you experience breathing problems after an air bag deployment, seek medical attention immediately.

Though the smoke and powder are nontoxic, they may cause irritation to the skin, eyes, nose, throat, etc. If this is the case, wash and rinse with cold water immediately and seek medical attention if the symptoms persist.

Do not install a Child Restraint System on the front passenger seat

■ Type A



OH1038169L

■ Type B

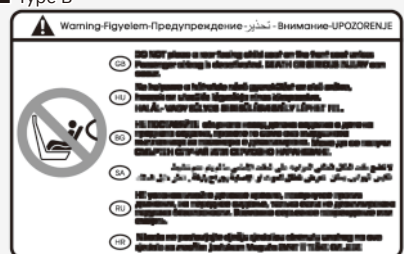

OH1038170L

Never install a Child Restraint System in the front passenger seat, unless the air bag is deactivated

WARNING

NEVER use a rearward facing Child Restraint on a seat protected by an **ACTIVE AIRBAG** in front of it, **DEATH** or **SERIOUS INJURY** to the **CHILD** can occur.

Why didn't my air bag go off in a collision?

There are certain types of accidents in which the air bag would not be expected to provide additional protection. These include rear impacts, second or third collisions in multiple impact accidents, as well as low speed impacts. Damage to the vehicle indicates a collision energy absorption, and is not an indicator of whether or not an air bag should have inflated.

Air bag collision sensors

WARNING

To reduce the risk of an air bag deploying unexpectedly and causing serious injury or death:

- Do not hit or allow any objects to impact the locations where air bags or sensors are installed.
- Do not perform maintenance on or around the air bag sensors. If the location or angle of the sensors is altered, the air bags may deploy when they should not or may not deploy when they should.
- Installing bumper guards with non-genuine Genesis or non-equivalent parts may adversely affect the collision and airbag deployment performance.

To ensure correct function of the airbag system, we recommend to replace the bumper with genuine Genesis part or the equivalent (of the genuine part) specified for your vehicle.

- Press the Engine Start/Stop button to the OFF or ACC position and wait for 3 minutes when the vehicle is being towed to prevent inadvertent air bag deployment.
- We recommend that all air bag repairs are conducted by an authorized retailer of Genesis Branded products.

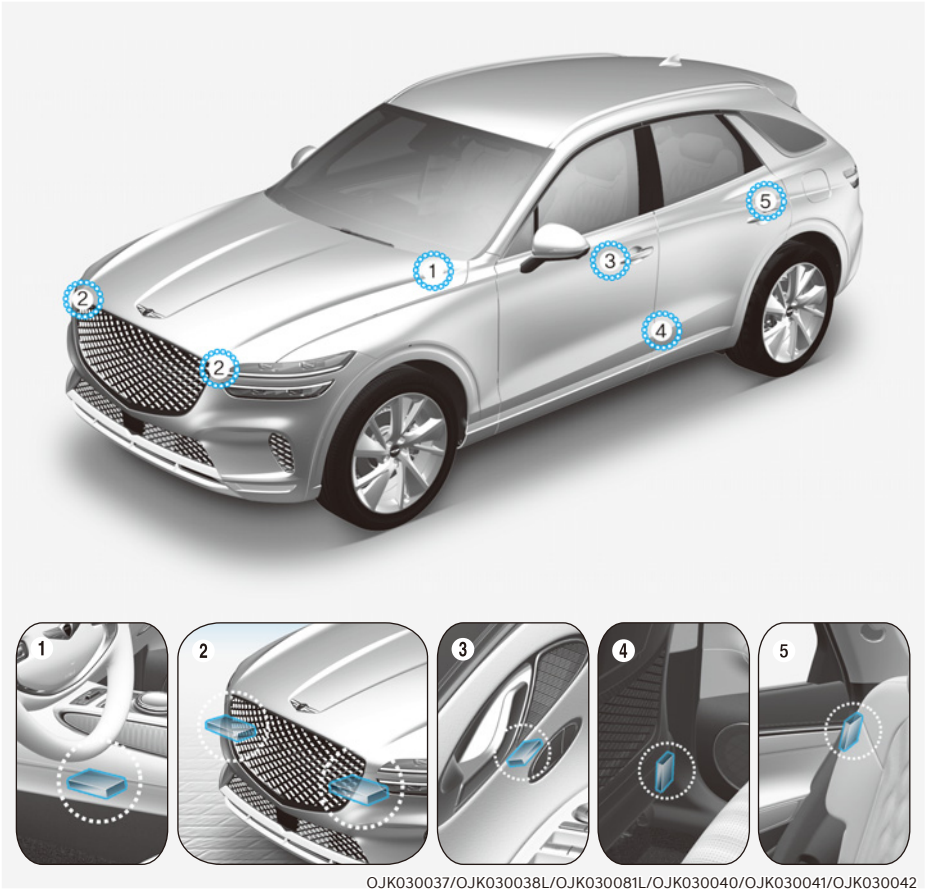

- 1. SRS control module / Rollover sensor
- 2. Front impact sensor
- 3. Side impact sensor (Pressure)
- 4. Side impact sensor (Acceleration)
- 5. Side impact sensor (Acceleration)

Air bag inflation conditions



Front air bags

Front air bags are designed to inflate in a frontal collision depending on the severity of impact of the front collision.

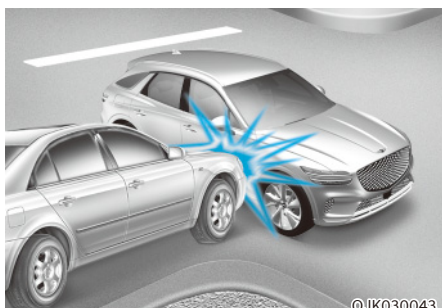

Side and curtain air bags and front center air bag

Side and curtain air bags and front center air bag are designed to inflate when an impact is detected by side collision sensors depending on the severity of impact resulting from a side impact collision.

Although the driver's and front passenger's air bags are designed to inflate in frontal collisions, they also may inflate in other types of collisions if the front impact sensors detect a sufficient impact. Side and curtain air bags and front center air bag are designed to inflate in side impact collisions, but they may inflate in other collisions if the side impact sensors detect a sufficient impact.

Also, the side and curtain air bags and front center air bag are designed to inflate when a rollover is detected by a rollover sensor (if equipped with rollover sensor).

If the vehicle chassis is impacted by bumps or objects on unimproved roads, the air bags may deploy. Drive carefully on unimproved roads or on surfaces not designed for vehicle traffic to prevent unintended air bag deployment.

Air bag non-inflation conditions



In certain low-speed collisions the air bags may not deploy. The air bags are designed not to deploy in such cases because they may not provide benefits beyond the protection of the seat belts.



Front air bags are not designed to inflate in rear collisions, because occupants are moved backward by the force of the impact. In this case, inflated air bags would not provide any additional benefit.

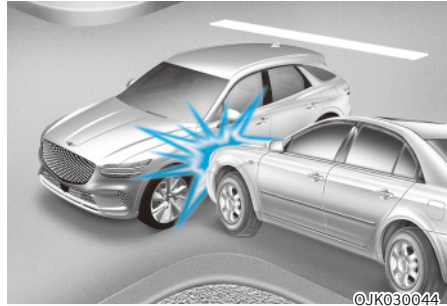

Front air bags may not inflate in side impact collisions, because occupants move in the direction of the collision, and thus in side impacts, front air bag deployment would not provide additional occupant protection.

However, side and curtain air bags and front center air bag may inflate depending on the severity of impact.

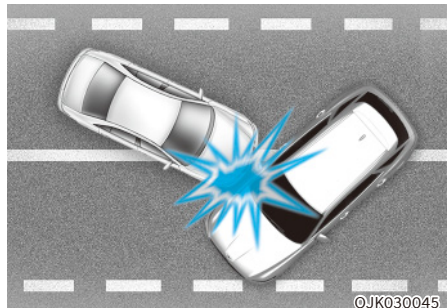

In an angled collision, the force of impact may direct the occupants in a direction where the air bags would not be able to provide any additional benefit, and thus the sensors may not deploy any air bags.

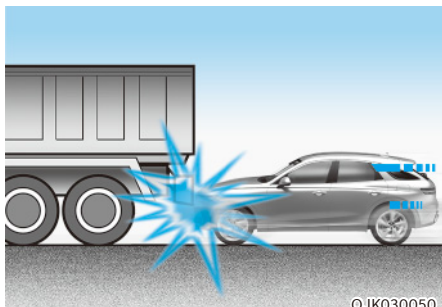

OJK030050

Just before impact, drivers often brake heavily. Such heavy braking lowers the front portion of the vehicle causing it to “ride” under a vehicle with a higher ground clearance. Air bags may not inflate in this “underride” situation because deceleration forces that are detected by sensors may be significantly reduced by such “underride” collisions.

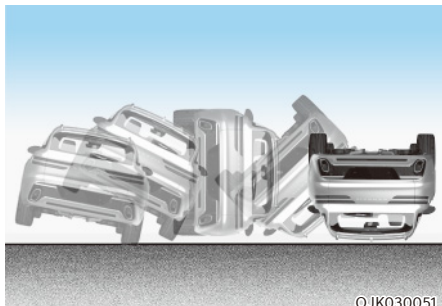

OJK030051

Front air bags may not inflate in rollover accidents because front air bag deployment would not provide additional occupant protection.

i Information

With rollover sensor

The side and curtain air bags and front center air bag may inflate in a rollover situation, when it is detected by the rollover sensor.

i Information

Without rollover sensor

The side and/or curtain air bags and front center air bag may inflate when the vehicle is rolled over by a side impact collision, if the vehicle is equipped with side and/or curtain air bags.

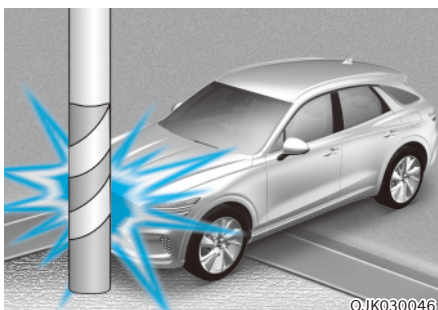

OJK030046

Air bags may not inflate if the vehicle collides with objects such as utility poles or trees, where the point of impact is concentrated and the collision energy is absorbed by the vehicle structure.

SRS care

The SRS is virtually maintenance-free and there are no parts you can safely service by yourself. If the SRS air bag warning light does not illuminate when the Engine Start/Stop button is in the ON position, or continuously remains on, we recommend that the system be immediately inspected by an authorized retailer of Genesis Branded products.

We recommend any work on the SRS system, such as removing, installing, repairing, or any work on the steering wheel, the front passenger's panel, front seats and roof rails be performed by an authorized retailer of Genesis Branded products. Improper handling of the SRS system may result in serious personal injury.



WARNING

To reduce the risk of serious injury or death take the following precautions:

- **Do not attempt to modify or disconnect the SRS components or wiring, including the addition of any kind of badges to the pad covers or modifications to the body structure.**
- **Do not place objects over or near the air bag modules on the steering wheel, instrument panel, and the front passenger's panel above the glove box.**
- **Clean the air bag pad covers with a soft cloth moistened with plain water. Solvents or cleaners could adversely affect the air bag covers and proper deployment of the system.**
- **We recommend that inflated air bags be replaced by an authorized retailer of Genesis Branded products.**
- **If components of the air bag system must be discarded, or if the vehicle must be scrapped, certain safety precautions must be observed. We recommend that you consult an authorized retailer of Genesis Branded products for the necessary information. Failure to follow these precautions could increase the risk of personal injury.**

Additional safety precautions

Passengers should not move out of or change seats while the vehicle is moving. A passenger who is not wearing a seat belt during a crash or emergency stop can be thrown against the inside of the vehicle, against other occupants, or be ejected from the vehicle.

Do not use any accessories on seat belts. Devices claiming to improve occupant comfort or reposition the seat belt can reduce the protection provided by the seat belt and increase the chance of serious injury in a crash.

Do not modify the front seats. Modification of the front seats could interfere with the operation of the supplemental restraint system sensing components or side air bags.

Do not place items under the front seats. Placing items under the front seats could interfere with the operation of the supplemental restraint system sensing components and wiring harnesses.

Do not cause impact to the doors. Impact to the doors when the Engine Start/Stop button is in the ON or START position may cause the air bags to inflate.

Adding equipment to or modifying your air bag equipped vehicle

If you modify your vehicle by changing your vehicle's frame, bumper system, front end or side sheet metal or ride height, this may affect the operation of your vehicle's air bag system.

Air bag warning labels

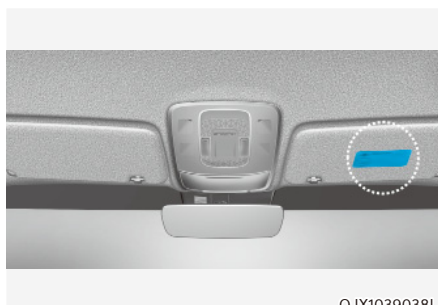

OJX1039038L

Air bag warning labels are attached to alert the passengers of potential risks of the air bag system.

Be sure to read all of the information about the air bags that are installed on your vehicle in this Owner's Manual.

4. Instrument cluster

Instrument cluster	4-4
Instrument cluster control.....	4-5
Instrument panel illumination.....	4-5
Gauges and meters	4-5
Speedometer	4-5
Tachometer	4-6
Engine coolant temperature gauge (for 12.3-inch 3D cluster).....	4-6
Fuel gauge.....	4-7
Outside temperature gauge.....	4-8
Odometer	4-9
Distance to empty	4-9
Fuel economy (for 12.3-inch 3D cluster)	4-10
Transmission shift indicator.....	4-10
Automatic transmission shift indicator	4-10
Automatic transmission shift indicator in Manual Shift mode	4-11
Warning and indicator lights	4-11
Seat belt warning light	4-11
Air bag warning light	4-11
Parking brake & Brake fluid warning light	4-12
Anti-lock Brake System (ABS) warning light	4-13
Electronic Brake Force Distribution (EBD) system warning light	4-13
Electric Power Steering (EPS) warning light	4-14
Charging system warning light.....	4-14
Engine oil pressure warning light	4-14
Engine coolant temperature warning light (for 8-inch cluster).....	4-15
Low fuel level warning light	4-15
Malfunction Indicator Lamp (MIL).....	4-16
Fuel filter warning light(for diesel engine)	4-17
Exhaust system (GPF) warning light (for gasoline engine)	4-18
Exhaust system (DPF) warning light (for diesel engine).....	4-18
SCR warning light (for diesel engine).....	4-18
Master warning light.....	4-19
Electronic Parking Brake (EPB) warning light	4-19
Low tire pressure warning light	4-20
Forward Safety warning light.....	4-20
Lane Safety indicator light	4-21
Over speed warning light	
All Wheel Drive (AWD) warning light	4-21
Intelligent Front-Lighting System warning light.....	4-21

LED headlight warning light.....	4-22
Icy road warning light.....	4-22
Electronic Stability Control (ESC) indicator light.....	4-23
Electronic Stability Control (ESC) OFF indicator light.....	4-23
Immobilizer indicator light.....	4-23
Glow indicator light(for diesel engine).....	4-24
Downhill Brake Control (DBC) indicator light.....	4-24
AUTO STOP indicator light.....	4-25
Turn signal indicator light.....	4-25
High beam indicator light.....	4-25
Low beam indicator light.....	4-26
Light ON indicator light.....	4-26
Rear fog indicator light.....	4-26
High Beam Assist indicator light.....	4-26
Intelligent Front-Lighting System indicator light.....	4-26
AUTO HOLD indicator light.....	4-26
LCD display messages.....	4-27
Shift to P.....	4-27
Vehicle is in N. Press START button and shift to P (and turn vehicle off).....	4-27
Low key battery.....	4-27
Press START button while turning wheel.....	4-27
Check steering wheel lock system.....	4-27
Press brake pedal to start engine.....	4-27
Key not in vehicle.....	4-27
Key not detected.....	4-27
Press START button again.....	4-27
Press START button with key.....	4-28
Check BRAKE SWITCH fuse.....	4-28
Shift to P or N to start engine.....	4-28
Check smart key system.....	4-28
Battery discharging due to external/additional electrical devices.....	4-28
Door, Hood, Tailgate open indicator.....	4-28
Sunroof open indicator.....	4-29
Low tire pressure.....	4-29
Lights.....	4-29

4. Instrument cluster

Wiper	4-30
Low washer fluid	4-30
Low fuel	4-30
Low engine oil	4-30
Engine overheated/Engine has overheated.....	4-31
Check exhaust system	4-31
Check haptic steering wheel system.....	4-31
Check headlight	4-31
Check turn signal	4-31
Check headlamp LED	4-31
LCD display.....	4-32
LCD display control	4-32
View modes	4-32
Driving Assist view	4-33
Turn By Turn (TBT) view	4-33
Utility view.....	4-34
Additional information display	4-38
Option menu.....	4-38
Service messages	4-39
3D cluster / 3D effect (for 12.3-inch 3D cluster)	4-39
Head-up display.....	4-39
Driver Assistance settings	4-39
Speed unit	4-40
3D instrument cluster (for 12.3-inch 3D cluster)	4-40
3D cluster setting.....	4-40
Recommendations to optimize the 3D effect	4-40
Vehicle Settings (infotainment system)	4-43
Setting your vehicle	4-43

INSTRUMENT CLUSTER

■ 8-inch



■ 12.3-inch 3D

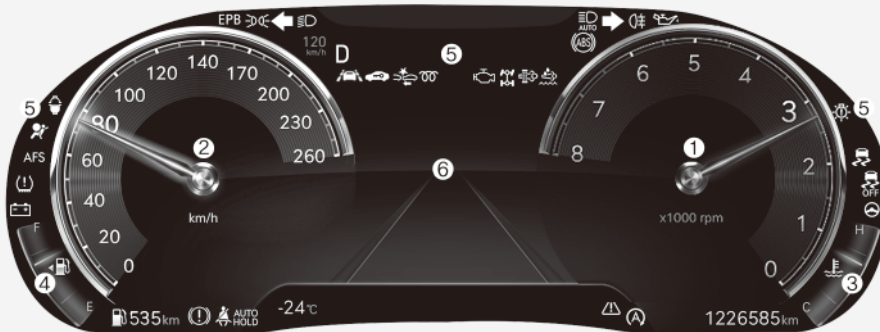

The actual cluster in the vehicle may differ from the illustration.
For more information, refer to “Gauges and meters” section in this chapter.

OJK040078L/OJX1049002L

- | | |
|-------------------------------------|---------------------------------|
| 1. Tachometer | 4. Fuel gauge |
| 2. Speedometer | 5. Warning and indicator lights |
| 3. Engine coolant temperature gauge | 6. LCD display |

i Information

Detailed information on 3D instrument cluster is provided later in this chapter.

Instrument cluster control

Instrument panel illumination

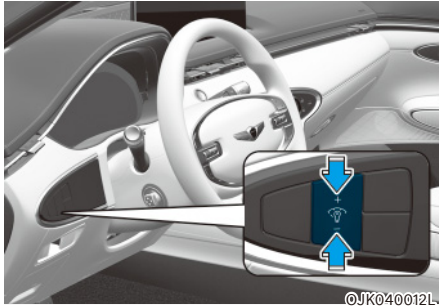

When the vehicle's position lights or headlamps are on, press the illumination control switch to adjust the brightness of the instrument panel illumination.

When pressing the illumination control switch, the interior switch illumination intensity is also adjusted.

The brightness of the instrument panel illumination is displayed on the cluster LCD display.

If the brightness reaches to the maximum or minimum level, a chime will sound.



WARNING

Never adjust the instrument cluster while driving. This could result in loss of control and lead to an accident that may cause death, serious injury, or vehicle damage.

Gauges and meters

Speedometer

- 8-inch
 - km/h



OJX1049030

- km/h, MPH



OJX1049030L

- MPH, km/h



OJX1049060L

- 12.3-inch 3D
 - km/h



OJX1049040

- MPH



OJX1049040L

The speedometer indicates the speed of the vehicle and is calibrated in kilometers per hour (km/h) and/or miles per hour (MPH).

Tachometer

■ 8-inch

- Gasoline engine



OJX1049031L

- Diesel engine



OJX1049031

■ 12.3-inch 3D

- Gasoline engine



OJX1049041L

- Diesel engine



OJX1049041

The tachometer indicates the approximate number of engine revolutions per minute (RPM).

Use the tachometer to select the correct shift points and to prevent lugging and/or over-revving the engine.

NOTICE

Do not operate the engine within the tachometer's RED ZONE. This may cause severe engine damage.

Engine coolant temperature gauge (for 12.3-inch 3D cluster)

■ Type A



OJX1049043

■ Type B



OJX1049043L

This gauge indicates the temperature of the engine coolant when the Engine Start/Stop button is in the ON position.

NOTICE

If the gauge pointer moves beyond the normal range area toward the "H (Hot) or 130" position, it indicates overheating that may damage the engine.

Do not continue driving with an overheated engine. If your vehicle overheats, refer to "If the Engine Overheats" section in chapter 8.

WARNING

Never remove the engine coolant reservoir cap when the engine is hot. The engine coolant is under pressure and could cause severe burn. Wait until the engine is cool before adding coolant to the reservoir.

Information

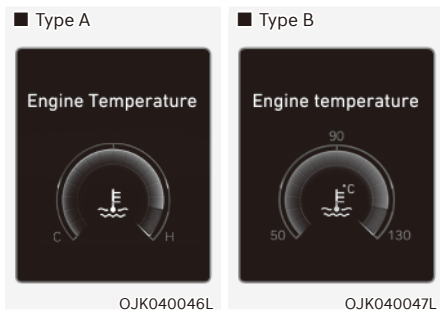

For 8-inch instrument cluster, you can check the engine coolant temperature in the Utility view on the cluster.

Refer to “View Modes” section in chapter 4.

Fuel gauge

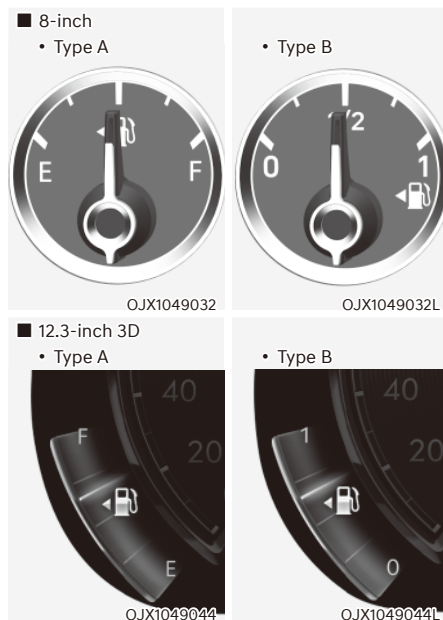

This gauge indicates the approximate amount of fuel remaining in the fuel tank.

Information

- The fuel tank capacity is given in chapter 2.
- The fuel gauge is supplemented by a low fuel warning light, which will illuminate when the fuel tank is nearly empty.
- On inclines or curves, the fuel gauge pointer may fluctuate or the low fuel warning light may come on earlier than usual due to the movement of fuel in the tank.

⚠ WARNING

Running out of fuel can expose vehicle occupants to danger.

You must stop and obtain additional fuel as soon as possible after the warning light comes on or when the gauge indicator comes close to the “E (Empty) or 0” level.

NOTICE

Avoid driving with an extremely low fuel level. Running out of fuel could cause the engine to misfire damaging the catalytic converter.

Outside temperature gauge



This gauge indicates the current outside air temperatures by 1°C (1°F).

Note that the temperature indicated on the LCD display may not change as quickly as the outside temperature (there may be a slight delay before the temperature changes.)

You can change the temperature unit from the Settings menu in the infotainment system screen. Select:

- Setup → General Settings → Unit → Temperature Unit → °C/°F

For detailed information, scan the QR code in a separately supplied simple manual.

Both the temperature unit on the cluster LCD display and climate control screen will change.

Odometer



OJX1049035

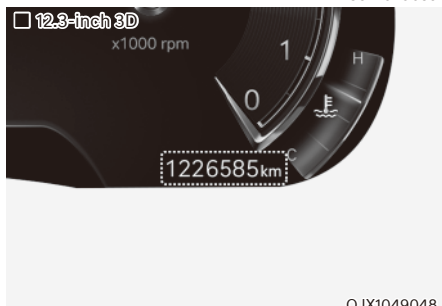

OJX1049048

The odometer indicates the total distance that the vehicle has been driven and should be used to determine when periodic maintenance should be performed.

Distance to empty



OJX1049036

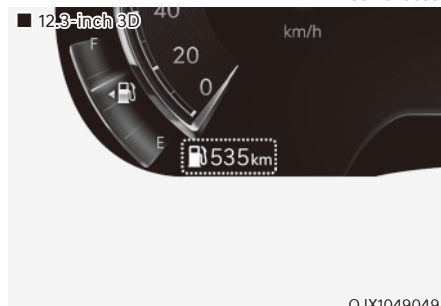

OJX1049049

- The distance to empty is the estimated distance the vehicle can be driven with the remaining fuel.
- If the estimated distance is below 1 km (1 mi.), the trip computer will display “---” as distance to empty.

i Information

- If the vehicle is not on level ground or the battery power has been interrupted, the distance to empty function may not operate correctly.
- The distance to empty may differ from the actual driving distance as it is an estimate of the available driving distance.
- The trip computer may not register additional fuel if less than 9 liters (2.4 gallon) of fuel are added to the vehicle.
- The distance to empty may vary significantly based on driving conditions, driving habits, and condition of the vehicle.

Fuel economy (for 12.3-inch 3D cluster)

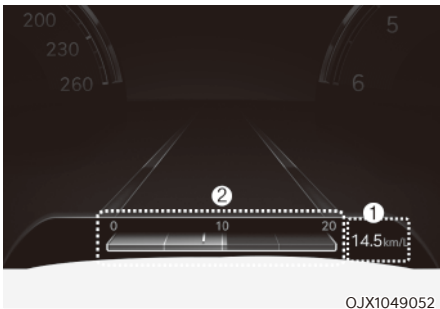

The average fuel economy (1) and instant fuel economy (2) is displayed at the bottom of the cluster.

Automatic reset

To automatically reset the average fuel economy, select between "After Ignition" or "After Refueling" from the Settings menu in the infotainment system screen.

Transmission shift indicator
Automatic transmission shift indicator

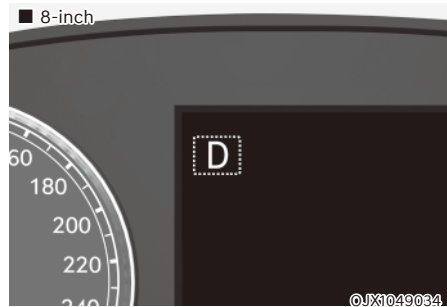

This indicator informs the current gear engaged.

Automatic transmission shift indicator in Manual Shift mode (for Europe, if equipped)

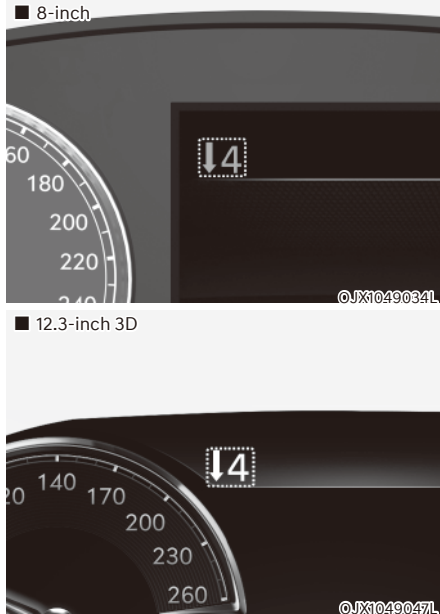

In the Manual Shift mode, this indicator informs which gear is recommended while driving, to save fuel.

For example

↑3: Indicates that shifting up to the 3rd gear is recommended (currently the vehicle is in the 2nd or 1st gear).

↓3: Indicates that shifting down to the 3rd gear is recommended (currently the vehicle is in the 4th, 5th, or 6th gear).

When the system is not working properly, the indicator is not displayed.

Warning and indicator lights

i Information

Make sure that all warning lights are OFF after starting the engine. If any light is still ON, this indicates a situation that needs attention.

Seat belt warning light



This warning light informs the driver that the seat belt is not fastened.

For more details, refer to “Seat Belts” section in chapter 3.

Air bag warning light



This warning light illuminates:

- When you set the Engine Start/Stop button to the ON position.
 - The air bag warning light illuminates for about 6 seconds and then turns off when all checks have been performed.
- The air bag warning light will remain illuminated if there is a malfunction with the Safety Restraint System (SRS) air bag operation.

If this occurs, we recommend that you have the vehicle inspected by an authorized retailer of Genesis Branded products.

Parking brake & Brake fluid warning light



This warning light illuminates:

- When you set the Engine Start/Stop button to the ON position.
 - The parking brake & brake fluid warning light illuminates for about 3 seconds and will then turn off once the parking brake is released.
- Whenever the parking brake is applied.
- Whenever the brake fluid level in the reservoir is low.
 - If the warning light illuminates with the parking brake released, it indicates the brake fluid level in the reservoir is low.

If the brake fluid level in the reservoir is low:

1. Drive carefully to the nearest safe location and stop your vehicle.
2. With the engine stopped, check the brake fluid level immediately and add fluid as required (**For more details, refer to “Brake Fluid” section in chapter 9**). After adding brake fluid, check all brake components for fluid leaks. If a brake fluid leak is found, or if the warning light remains on, or if the brakes do not operate properly, do not drive the vehicle. We recommend that you have the vehicle inspected by an authorized retailer of Genesis Branded products.

Dual-diagonal braking system

Your vehicle is equipped with dual-diagonal braking system. This means you still have braking on two wheels even if one of the dual systems should fail.

With only one of the dual systems working, more than normal pedal travel and greater pedal pressure is required to stop the vehicle.

Also, the vehicle will not stop in as short a distance with only a portion of the brake system working.

If the brakes fail while you are driving, shift to a lower gear for additional engine braking and stop the vehicle as soon as it is safe to do so.



WARNING

Parking Brake & Brake Fluid warning light

Driving the vehicle with a warning light ON is dangerous. If the Parking Brake & Brake Fluid warning light illuminates with the parking brake released, it indicates that the brake fluid level is low.

If this occurs, we recommend that you have the vehicle inspected by an authorized retailer of Genesis Branded products.

Anti-lock Brake System (ABS) warning light



This warning light illuminates:

- When you set the Engine Start/Stop button to the ON position.
 - The ABS warning light illuminates for about 3 seconds and then goes off.
- Whenever there is a malfunction with the ABS.

Note that the hydraulic braking system will still be operational even if there is a malfunction with the ABS.

If this occurs, we recommend that you have the vehicle inspected by an authorized retailer of Genesis Branded products.

Electronic Brake Force Distribution (EBD) system warning light



When the ABS warning and Parking Brake warning lights are on simultaneously, it may indicate a problem with the Electronic Brake Force Distribution system.

If this occurs, we recommend that you have the vehicle inspected by an authorized retailer of Genesis Branded products.



WARNING

Electronic Brake Force Distribution (EBD) system warning light

When both ABS and Parking Brake & Brake Fluid warning lights are on, the brake system will not work normally and you may experience an unexpected and dangerous situation during sudden braking.

If this occurs, avoid high speed driving and abrupt braking.

We recommend that you have the vehicle inspected by an authorized retailer of Genesis Branded products as soon as possible.

NOTICE

Electronic Brake Force Distribution (EBD) system warning light

When the ABS warning light is on or both ABS and Parking Brake & Brake Fluid warning lights are on, the speedometer, odometer, or tripmeter may not work. Also, the EPS warning light may illuminate and the steering effort may increase or decrease.

If this occurs, we recommend that you have the vehicle inspected by an authorized retailer of Genesis Branded products as soon as possible.

Electric Power Steering (EPS) warning light



This warning light illuminates:

- When you set the Engine Start/Stop button to the ON position.
 - The electric powering steering warning light illuminates for about 3 seconds and then goes off.
- Whenever there is a malfunction with the electric power steering.
If this occurs, we recommend that you have the vehicle inspected by an authorized retailer of Genesis Branded products.

Charging system warning light



This warning light illuminates:

When there is a malfunction with either the alternator or electrical charging system.

If there is a malfunction with either the alternator or electrical charging system:

1. Drive carefully to the nearest safe location and stop your vehicle.
2. Turn the engine off and check the alternator drive belt for looseness or breakage.

If the belt is adjusted properly, there may be a problem in the electrical charging system.

If this occurs, we recommend that you have the vehicle inspected by an authorized retailer of Genesis Branded products as soon as possible.

Engine oil pressure warning light



This warning light illuminates:

When the engine oil pressure is low.

If the engine oil pressure is low:

1. Drive carefully to the nearest safe location and stop your vehicle.
2. Turn the engine off and check the engine oil level (**For more details, refer to “Engine Oil” section in chapter 9**). If the level is low, add oil as required.

If the warning light remains on after adding oil or if oil is not available, we recommend that you have the vehicle inspected by an authorized retailer of Genesis Branded products as soon as possible.

Continued driving with the warning light on may cause engine failure.

Information

When engine oil pressure decreases due to insufficient engine oil, etc., the Engine Oil Pressure warning light will illuminate. In addition, the enhanced engine protection system which limits engine power will be activated. If the engine oil pressure is restored, the Engine Oil Pressure warning light and the enhanced engine protection system will turn off. However, for gasoline 2.5 turbo engine, when the engine oil pressure is restored, the warning light and the enhanced engine protection system will turn off after the engine is restarted.

NOTICE

- If the engine is not stopped immediately after the Engine Oil Pressure warning light is illuminated, severe damage could result.
- If the warning light stays on while the engine is running, it indicates that there may be serious engine damage or malfunction. In this case:
 1. Stop the vehicle as soon as it is safe to do so.
 2. Turn off the engine and check the oil level. If the oil level is low, fill the engine oil to the proper level.
 3. Start the engine again. If the warning light stays on after the engine is started, turn the engine off immediately. If this occurs, we recommend that you have the vehicle inspected by an authorized retailer of Genesis Branded products.

Engine coolant temperature warning light (for 8-inch cluster)

The warning light illuminates:

When the temperature of the engine coolant is extremely high.

Do not continue driving with an overheated engine. If your vehicle overheats, refer to “Overheating” section in chapter 8.

NOTICE

If the Engine Coolant Temperature warning light illuminates, it indicates overheating that may damage the engine.

Low fuel level warning light

This warning light illuminates:

When the fuel tank is nearly empty. Add fuel as soon as possible.

NOTICE

Driving with the Low Fuel Level warning light on or with the fuel level below “E or 0” can cause the engine to misfire and damage the catalytic converter.

Malfunction Indicator Lamp (MIL)



This indicator light illuminates:

- When you set the Engine Start/Stop button to the ON position.
 - The malfunction indicator light illuminates for about 3 seconds and then goes off.
- Whenever there is a malfunction with either the emission control system or the engine or the vehicle powertrain.

If this occurs, we recommend that you have the vehicle inspected by an authorized retailer of Genesis Branded products.

NOTICE

- **Driving with the Malfunction Indicator Lamp (MIL) on may cause damage to the emission control system which could affect drivability and/or fuel economy.**
- **If the enhanced engine protection system becomes activated operation due to lack of engine oil, engine power will be limited. If such condition continues repeatedly, the Malfunction Indicator Lamp will illuminate.**

NOTICE

- **Gasoline engine**

If the Malfunction Indicator Lamp (MIL) illuminates, potential catalytic converter damage is possible which could result in loss of engine power.

If this occurs, we recommend that you have the vehicle inspected by an authorized retailer of Genesis Branded products as soon as possible.

- **Diesel engine**

If the Malfunction Indicator Lamp (MIL) blinks, an error related to the engine control system may have occurred which could result in loss of engine power, combustion noise and poor emission.

If this occurs, we recommend that you have the vehicle inspected by an authorized retailer of Genesis Branded products.

NOTICE

Diesel engine with DPF

When the Malfunction Indicator Lamp (MIL) blinks, it may stop blinking after driving the vehicle:

- at more than 60km/h (40 mph), or
- at more than 2nd gear with 1,250 - 2,500 engine RPM for a certain time (for about 30 minutes).

If the Malfunction Indicator Lamp (MIL) continues to blink in spite of the procedure, we recommend that you have the DPF system checked by an authorized retailer of Genesis Branded products.

If you continue to drive with the Malfunction Indicator Lamp (MIL) blinking for a long time, the DPF system can be damaged and fuel consumption can worsen.

**Fuel filter warning light
(for diesel engine)**

This warning light illuminates:

When water has accumulated inside the fuel filter.

If this occurs, we recommend an authorized retailer of Genesis Branded products remove water from the fuel filter.

For more details, refer to "Fuel Filter" section in chapter 9.

NOTICE

- When the Fuel Filter warning light illuminates, engine power (vehicle speed & idle speed) may decrease.
- If you keep driving with the warning light on, engine parts (injector, common rail, high pressure fuel pump) may be damaged. If this occurs, we recommend that you have the vehicle inspected by an authorized retailer of Genesis Branded products as soon as possible.

**Exhaust system (GPF)
warning light (for gasoline
engine, if equipped)**



- This warning light illuminates, when accumulated soot reaches a certain amount.
- When this warning light illuminates, it may turn off after driving the vehicle at more than 80 km/h (50 mph) for about 30 minutes (above 3rd gear with 1500 ~ 4000 engine RPM).

If this warning light blinks in spite of the procedure (at this time LCD warning message will be displayed), we recommend that you have the GPF system checked by an authorized retailer of Genesis Branded products.

NOTICE

If you continue to drive with the GPF warning light blinking for a long time, the GPF system can be damaged and fuel consumption can worsen.

**Exhaust system (DPF)
warning light (for diesel
engine, if equipped)**



- This warning light illuminates when there is a malfunction with the Diesel Particulate Filter (DPF) system.
- When this warning light illuminates, it may turn off after driving the vehicle at more than 60 km/h (40 mph) for about 30 minutes (above 2nd gear with 1,250 - 2,500 engine RPM).

If this warning light blinks in spite of the procedure (at this time LCD warning message will be displayed), we recommend that you have the DPF system checked by an authorized retailer of Genesis Branded products.

NOTICE

If you continue to drive with the DPF warning light blinking for a long time, the DPF system can be damaged and fuel consumption can worsen.

**SCR warning light
(for diesel engine, if
equipped)**



This warning light illuminates:

When the urea solution tank is nearly empty.

If the urea solution tank is nearly empty, refill urea solution as soon as possible.

For more details, refer to "Urea Solution Purity" section in chapter 9.

Master warning light**This warning light illuminates:**

When there is a malfunction in operation in any of the following systems:

- Forward Collision-Avoidance Assist malfunction (if equipped)
- Forward Collision-Avoidance Assist radar blocked (if equipped)
- Blind-Spot Collision Warning malfunction (if equipped)
- Blind-Spot Collision Warning radar blocked (if equipped)
- LED headlamp malfunction (if equipped)
- High Beam Assist malfunction (if equipped)
- Smart Cruise Control malfunction (if equipped)
- Smart Cruise Control radar blocked (if equipped)
- Tire Pressure Monitoring System (TPMS) malfunction

To identify the details of the warning, look at the LCD display.

Electronic Parking Brake (EPB) warning light**EPB****This warning light illuminates:**

- When you set the Engine Start/Stop button to the ON position.
 - The EPB warning light illuminates for about 3 seconds and then goes off.
- Whenever there is a malfunction with EPB.

If this occurs, we recommend that you have the vehicle inspected by an authorized retailer of Genesis Branded products.

Information

The Electronic Parking Brake (EPB) warning light may illuminate when the Electronic Stability Control (ESC) indicator light comes on to indicate that ESC is not working properly. This does not indicate malfunction of EPB.

Low tire pressure warning light



This warning light illuminates:

- When you set the Engine Start/Stop button to the ON position.
 - The low tire pressure warning light illuminates for approximately 3 seconds and then goes off.
- When one or more of your tires are significantly underinflated. (The location of the underinflated tires are displayed on the LCD display.)

For more details, refer to “Tire Pressure Monitoring System (TPMS)” section in chapter 8.

This warning light remains ON after blinking for approximately 60 seconds, or repeatedly blinks ON and OFF in 3 second intervals:

When there is a malfunction with the TPMS.

If this occurs, we recommend that you have the vehicle inspected by an authorized retailer of Genesis Branded products as soon as possible.

For more details, refer to “Tire Pressure Monitoring System (TPMS)” section in chapter 8.

WARNING

Safe Stopping

- **The TPMS cannot alert you to severe and sudden tire damage caused by external factors.**
- **If you notice any vehicle instability, immediately take your foot off the accelerator pedal, apply the brakes gradually with light force, and slowly move to a safe position off the road.**

Forward Safety warning light (if equipped)



This warning light illuminates:

- When you set the Engine Start/Stop button to the ON position.
 - The Forward Safety warning light illuminates for approximately 3 seconds and then goes off.
- Whenever there is a malfunction with Forward Collision-Avoidance Assist.

If this occurs, we recommend that you have the vehicle inspected by an authorized retailer of Genesis Branded products.

For more details, refer to “Forward Collision-Avoidance Assist (FCA)” section in chapter 7.

**Lane Safety indicator light
(if equipped)**

This indicator light illuminates:

- [Green] When the system operating conditions are satisfied.
- [White] When the system operating conditions are not satisfied.
- [Yellow] Whenever there is a malfunction with Lane Keeping Assist.

If this occurs, we recommend that you have the vehicle inspected by an authorized retailer of Genesis Branded products.

For more details, refer to “Lane Keeping Assist (LKA)” section in chapter 7.

**Over speed warning light
(if equipped)**

**120
km/h**

This warning light blinks:

When you drive the vehicle more than 120 km/h.

- This is to prevent you from over speeding.
- The over speed warning chime also sound for approximately 5 seconds.

**All Wheel Drive (AWD)
warning light (if equipped)**

This warning light illuminates:

Whenever there is a malfunction with the AWD system.

If this occurs, we recommend that you have the vehicle inspected by an authorized retailer of Genesis Branded products.

For more details, refer to “All Wheel Drive (AWD)” section in chapter 6.

**Intelligent Front-Lighting
System warning light
(if equipped)**

AFS

This warning light illuminates:

- When you set the Engine Start/Stop Button to the ON position.
 - The Intelligent Front-Lighting System warning light illuminates for approximately 3 seconds and then goes off.
- Whenever there is a malfunction with Intelligent Front-Lighting System.

If this occurs, drive your vehicle to the nearest safe location, and turn the engine off and restart the engine. If the warning light remains on, we recommend that you have the vehicle inspected by an authorized retailer of Genesis Branded products.

**LED headlight warning light
(if equipped)**



This warning light illuminates:

- When you set the Engine Start/Stop button to the ON position.
 - The LED headlight warning light illuminates for approximately 3 seconds and then goes off.
- Whenever there is a malfunction with the LED headlight.

If this occurs, we recommend that you have the vehicle inspected by an authorized retailer of Genesis Branded products.

This warning light blinks:

Whenever there is a malfunction with a LED headlight related part.

If this occurs, we recommend that you have the vehicle inspected by an authorized retailer of Genesis Branded products.

NOTICE

Continuous driving with the LED Headlight warning light on or blinking can reduce LED headlight life.

**Icy road warning light
(if equipped)**



This warning light is to warn the driver the road may be icy.

When the temperature on the outside temperature gauge is approximately below 4°C (40°F), the Icy Road warning light and Outside Temperature Gauge blinks and then illuminates. Also, the warning chime sounds 1 time.

You can activate or deactivate Icy Road Warning function from the Settings menu in the infotainment system screen. Select:

- Setup → Vehicle Settings → Cluster → Content Selection → Icy Road Warning

For detailed information, scan the QR code in the separately supplied simple manual.

 Information

If the Icy Road warning light appears while driving, you should drive more attentively and safely refraining from over-speeding, rapid acceleration, sudden braking or sharp turning, etc.

Electronic Stability Control (ESC) indicator light



This indicator light illuminates:

- When you set the Engine Start/Stop button to the ON position.
 - The Electronic Stability Control indicator light illuminates for about 3 seconds and then goes off.
- Whenever there is a malfunction with ESC system.
If this occurs, we recommend that you have the vehicle inspected by an authorized retailer of Genesis Branded products.

This indicator light blinks:

While ESC is operating.

For more details, refer to “Electronic Stability Control (ESC)” section in chapter 6.

Electronic Stability Control (ESC) OFF indicator light



This indicator light illuminates:

- When you set the Engine Start/Stop button to the ON position.
 - The ESC OFF indicator light illuminates for approximately 3 seconds and then goes off.
- When you deactivate ESC system by pressing the ESC OFF button.

For more details, refer to “Electronic Stability Control (ESC)” section in chapter 6.

Immobilizer indicator light



This indicator light illuminates for up to 30 seconds:

When the vehicle detects the smart key in the vehicle with the Engine Start/Stop button in the ACC or ON position.

- Once the smart key is detected, you can start the engine.
- The indicator light goes off after starting the engine.

This indicator light blinks for a few seconds:

When the smart key is not in the vehicle.

- If the smart key is not detected, you cannot start the engine.

This indicator light illuminates for 2 seconds and goes off:

If the smart key is in the vehicle and the Engine Start/Stop button is ON, but the vehicle cannot detect the smart key.

If this occurs, we recommend that you have the vehicle inspected by an authorized retailer of Genesis Branded products.

This indicator light blinks:

Whenever there is a malfunction with the immobilizer system.

If this occurs, we recommend that you have the vehicle inspected by an authorized retailer of Genesis Branded products.

**Glow indicator light
(for diesel engine)**



This indicator light illuminates:

When the engine is being preheated with the Engine Start/Stop button in the START position.

- The engine can be started after the glow indicator light goes off.
- The illumination time varies depending on the engine coolant temperature, air temperature, and battery condition.

If the indicator light remains on or blinks after the engine has warmed up or while driving, there may be a malfunction with the engine preheating system.

If this occurs, we recommend that you have the vehicle inspected by an authorized retailer of Genesis Branded products.

**Downhill Brake Control (DBC)
indicator light (if equipped)**



This indicator light illuminates:

- When you set the Engine Start/Stop button to the ON position.
 - The downhill brake control indicator light illuminates for about 3 seconds and then goes off.
- When you activate the system by pressing the DBC button.

This indicator light blinks:

When Downhill Brake Control system is operating.

This indicator light illuminates yellow:

Whenever there is a malfunction with Downhill Brake Control system.

If this occurs, we recommend that you have the vehicle inspected by an authorized retailer of Genesis Branded products.

For more details, refer to "Downhill Brake Control (DBC)" section in chapter 6.

**AUTO STOP indicator light
(if equipped)**

This indicator light illuminates:

- [White] When the system operating conditions are satisfied.
- [Green] When the ISG system is activated.
- [Yellow] Whenever there is a malfunction with the ISG function.

If this occurs, we recommend that you have the vehicle inspected by an authorized retailer of Genesis Branded products.

For more details, refer to "ISG (Idle Stop and Go) system" section in chapter 6.

Information

When the engine automatically starts by the ISG system, some warning lights (ABS, ESC, ESC OFF, EPS or Parking brake warning light) may turn on for a few seconds. This happens because of low battery voltage. It does not mean the system has malfunctioned.

Turn signal indicator light

This indicator light blinks:

When you operate the turn signal indicator stalk.

If any of the following occur, there may be a malfunction with the turn signal system.

- The turn signal indicator light illuminates but does not blink
- The turn signal indicator light blinks rapidly
- The turn signal indicator light does not illuminate at all

If any of these conditions occur, we recommend that you have the vehicle inspected by an authorized retailer of Genesis Branded products.

High beam indicator light

This indicator light illuminates:

- When the headlamps are on and in the high beam position
- When the turn signal lever is pulled into the Flash-to-Pass position.

Low beam indicator light



This indicator light illuminates:
When the headlamps are on.

Light ON indicator light



This indicator light illuminates:
When the position lamps or headlamps are on.

Rear fog indicator light (if equipped)



This indicator light illuminates:
When the rear fog lamps are on.

High Beam Assist indicator light (if equipped)



This indicator light illuminates:
When the high-beam is on with the light switch in the AUTO position.
If your vehicle detects oncoming or preceding vehicles, High Beam Assist will switch the high beam to low beam automatically.

For more details, refer to “High Beam Assist (HBA)” section in chapter 5.

Intelligent Front-Lighting System indicator light (if equipped)



This indicator light illuminates:
When the high-beam is on with the light switch in the AUTO position.
If your vehicle detect oncoming or preceding vehicles, the Intelligent Front-Lighting system partially turns off the high beam LED lamps.

For more details, refer to “Intelligent Front-Lighting System” section in chapter 5.

AUTO HOLD indicator light



This indicator light illuminates:

- [White] When you activate Auto Hold by pressing the AUTO HOLD switch.
- [Green] When you stop the vehicle completely by depressing the brake pedal with Auto Hold activated.
- [Yellow] Whenever there is a malfunction with the Auto Hold function.

If this occurs, we recommend that you have the vehicle inspected by an authorized retailer of Genesis Branded products.

For more details, refer to “Electronic Parking Brake (EPB)” section in chapter 6.

LCD display messages

Shift to P

This message is displayed if you try to turn off the vehicle without the gear in the P (Park) position.

If this occurs, the Engine Start/Stop button turns to the ACC position.

Vehicle is in N. Press START button and shift to P (and turn vehicle off)

This message is displayed if you try to turn off the vehicle with the gear in N (Neutral).

To turn off the vehicle:

1. Press the Engine Start/Stop button. The button will change to the ON position.
2. Press the P button to shift to P (Park).
3. Press the Engine Start/Stop button again, then the vehicle will turn off.

Low key battery

This message is displayed if the battery of the smart key is discharged while changing the Engine Start/Stop button to the OFF position.

Press START button while turning wheel (if equipped)

This message is displayed if the steering wheel does not unlock normally when the Engine Start/Stop button is pressed.

You should press the Engine Start/Stop button while turning the steering wheel right and left.

Check steering wheel lock system (if equipped)

This message is displayed if the steering wheel does not lock normally while the Engine Start/Stop button is pressed to the OFF position.

Press brake pedal to start engine

This message is displayed if the Engine Start/Stop button changes to the ACC position twice by pressing the button repeatedly without depressing the brake pedal.

You can start the vehicle by depressing the brake pedal and then pressing the Engine Start/Stop button.

Key not in vehicle

This message is displayed if the smart key is not in the vehicle when you leave the vehicle with the Engine Start/Stop button in the ON or Start position.

Always turn off the engine before leaving your vehicle.

Key not detected

This message is displayed if the smart key is not detected when you press the Engine Start/Stop button.

Press START button again

This message is displayed if you were unable to start the vehicle when the Engine Start/Stop button was pressed.

If this occurs, attempt to start the engine by pressing the Engine Start/ Stop button again.

If the warning message appears each time you press the Engine Start/Stop button, we recommend that you have the vehicle inspected by an authorized retailer of Genesis Branded products.

Press START button with key

This message is displayed if you press the Engine Start/Stop button while the warning message “Key not detected” is displayed.

At this time, the immobilizer indicator light blinks.

Check BRAKE SWITCH fuse

This message is displayed if the brake switch fuse is disconnected.

You need to replace the fuse with a new one before starting the engine.

If that is not possible, you can start the engine by pressing the Engine Start/ Stop button for 10 seconds in the ACC position.

Shift to P or N to start engine

This message is displayed if you try to start the engine in any other position except P (Park) or N (Neutral).

***i* Information**

You can start the engine with the gear in N (Neutral). But, for your safety, we recommend that you start the engine with the gear shifted to P (Park).

Check smart key system

This message is displayed when there is a problem with the smart key system. We recommend that you have the vehicle inspected by an authorized retailer of Genesis Branded products.

Battery discharging due to external/ additional electrical devices

This message is displayed if the 12V battery voltage is weak due to any non-factory electrical accessories (ex. dashboard camera) while parking. Be careful that the battery is not discharged.

If the message appears after removing the non-factory electrical accessories, we recommend that you have the vehicle inspected by an authorized retailer of Genesis Branded products.

Door, Hood, Tailgate open indicator

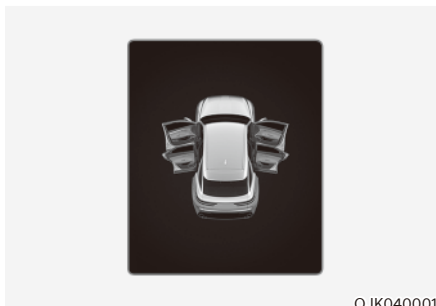

This warning is displayed if any door or hood or tailgate is left open. The warning will indicate which door is open in the display.



CAUTION

Before driving the vehicle, you should confirm that the door/ hood/tailgate is fully closed.

Sunroof open indicator (if equipped)

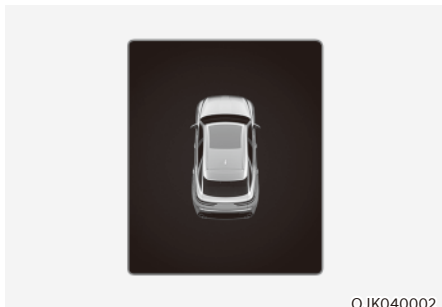

This warning is displayed if you turn off the engine when the sunroof is open. Close the sunroof securely before leaving your vehicle.

Low tire pressure

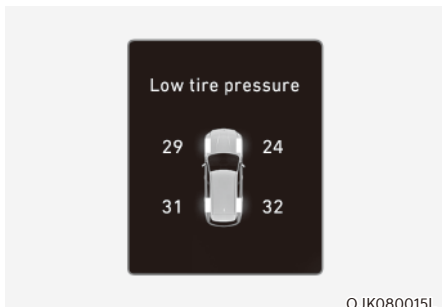

This warning message is displayed if the tire pressure is low. The corresponding tire on the vehicle will be illuminated.

For more details, refer to “Tire Pressure Monitoring System (TPMS)” section in chapter 8.

Lights



This indicator displays which exterior light is selected using the lighting control.

You can activate or deactivate Wiper/Lights display function from the Settings menu in the infotainment system screen. Select:

- Setup → Vehicle Settings → Cluster → Content Selection → Wiper/Lights Display

For detailed information, scan the QR code in the separately supplied simple manual.

Wiper



This indicator displays which wiper speed is selected using the wiper control.

You can activate or deactivate Wiper/Lights display function from the Settings menu in the infotainment system screen. Select:

- Setup → Vehicle Settings → Cluster → Content Selection → Wiper/Lights Display

For detailed information, scan the QR code in the separately supplied simple manual.

Low washer fluid

This message is displayed if the washer fluid level in the reservoir is nearly empty. Have the washer fluid reservoir refilled.

Low fuel

This message is displayed if the fuel tank is almost out of fuel.

When this message is displayed, the low fuel level warning light in the cluster will come on.

It is recommended to look for the nearest fueling station and refuel as soon as possible.

Low engine oil (if equipped)

This warning message is displayed when the engine oil level should be checked.

If this warning message is displayed, check the engine oil level as soon as possible and add engine oil as required.

Slowly pour the recommended oil little by little into a funnel.

Use only the specified engine oil. (Refer to "Recommended Lubricants and Capacities" section in chapter 2.)

Do not overfill the engine oil. Make sure the oil level is not above F (Full) mark on the dipstick.

Information

After adding engine oil, if you travel approximately 50~100 km (31~62 miles) after the engine warms up, the warning message will disappear.

Engine overheated/Engine has overheated

This message is displayed when the engine coolant temperature is above 120°C (248°F). This means that the engine is overheated and may be damaged.

If your vehicle is overheated, refer to “Overheating” section in chapter 8.

Check exhaust system (if equipped)

This message is displayed if there is a problem with the GPF or DPF system. At this time, the GPF warning light will also blink. If this occurs, we recommend that you have the GPF or DPF system checked by an authorized retailer of Genesis Branded products.

GPF : Gasoline Particulate Filter

DPF : Diesel Particulate Filter

Check haptic steering wheel system (if equipped)

This message is displayed if there is a problem with the haptic steering wheel system. We recommend that you have the vehicle inspected by an authorized retailer of Genesis Branded products.

Check headlight (if equipped)

This message is displayed if the headlights are not operating properly. A lamp may need to be replaced.

Make sure to replace the burned out bulb with a new one of the same wattage rating.

Check turn signal (if equipped)

This message is displayed if the turn signal lamps are not operating properly. A lamp may need to be replaced.

Make sure to replace the burned out bulb with a new one of the same wattage rating.

Check headlamp LED (if equipped)

This message is displayed if there is a problem with the LED headlamp. We recommend that you have the vehicle inspected by an authorized retailer of Genesis Branded products.

LCD DISPLAY

LCD display control

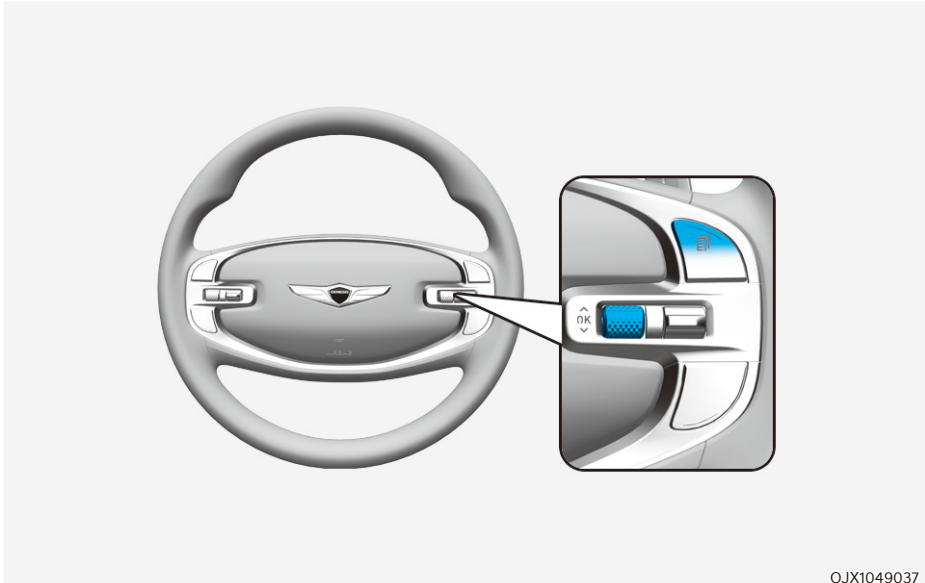

OJX1049037

The LCD display modes can be changed by using the control switches.

Switch	Operation	Function
	Press	MODE button for changing View modes
	Press	UP, DOWN switch for changing items in Utility view and Option menu
OK	Press	SELECT/RESET switch for entering Option menu
	Press and hold	SELECT/RESET switch for retrieving assist information or resetting the selected item

View modes

View modes	Explanation
Driving Assist	Driving Assist view displays the status of the vehicle's Driving Assistance systems.
Turn by Turn	Turn By Turn view displays the state of the navigation.
Utility	Utility view displays driving information such as the trip distance, fuel economy and etc.

The information provided may differ depending on which features are applicable to your vehicle.



Driving Assist, Turn by Turn, Utility view modes are displayed in the center (A) of the instrument cluster.

Driving Assist view

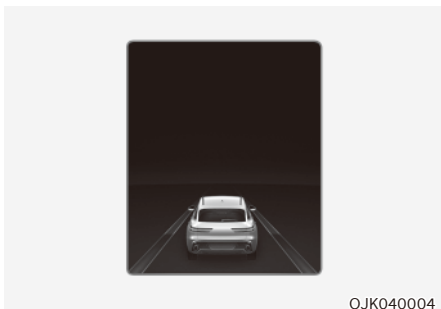

The status of Manual Speed Limit Assist, Cruise Control, Smart Cruise Control, Lane Following Assist, Highway Driving Assist, etc. is displayed when Driving Assist view is selected.

For more details, refer to each system information section in chapter 7.

Turn By Turn (TBT) view

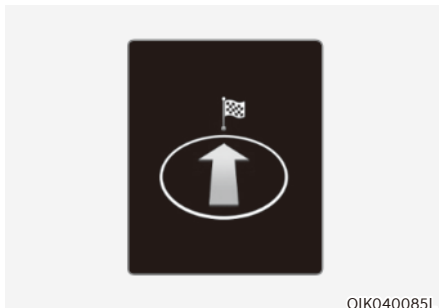

Turn-by-turn navigation, distance/time to destination information is displayed when Turn by Turn view is selected.

Utility view

In the Utility view, using the \wedge , \vee (UP, DOWN) switch, you may change through items in the following order.

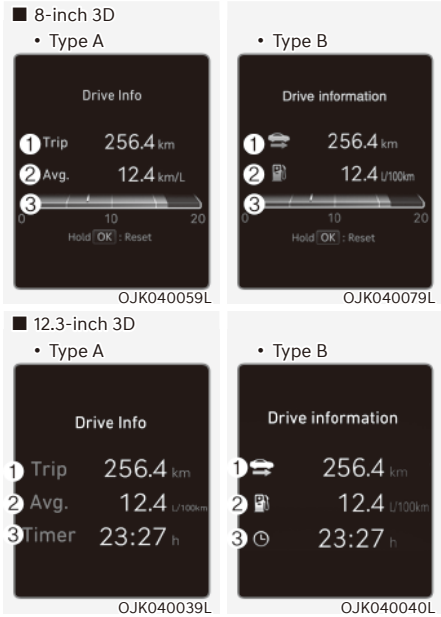

Drive info

Trip distance (1), average fuel economy (2), and instant fuel economy (8-inch)/total driving time(12.3-inch 3D) (3) are displayed.

The information is combined for each ignition cycle. However, when the driver's door is opened after turning off the engine or the engine is turned on after 3 minutes have passed, the Drive Info screen will reset.

To reset manually, press the OK switch on the steering wheel for more than 1 second when 'Drive Info' is displayed.

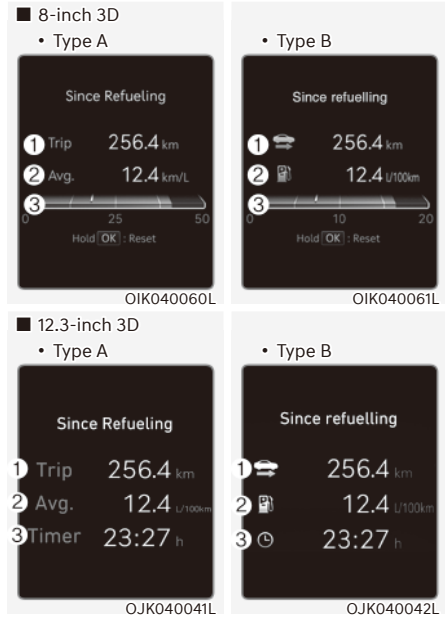

Since refuel(ing)

Trip distance (1), average fuel economy (2), and instant fuel economy (8-inch)/total driving time(12.3-inch 3D) (3) after the vehicle has been refueled are displayed.

To reset manually, press the OK switch on the steering wheel for more than 1 second when 'Since Refueling' is displayed.



Accumulated info

Accumulated trip distance (1), average fuel economy (2), and instant fuel economy (8-inch)/total driving time (12.3-inch 3D) (3) are displayed.

The information is accumulated starting from the last reset.

To reset manually, press the OK switch on the steering wheel for more than 1 second when 'Accumulated Info' is displayed.



Digital speedometer

Digital speedometer display shows the speed of the vehicle.

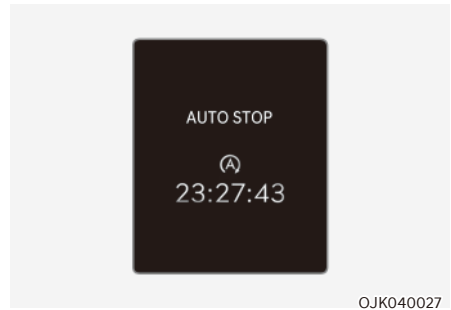

Auto stop (if equipped)

AUTO STOP display shows the elapsed time of engine stop by Idle Stop and Go system.

For more details, refer to "Idle Stop and Go (ISG)" section in chapter 6.

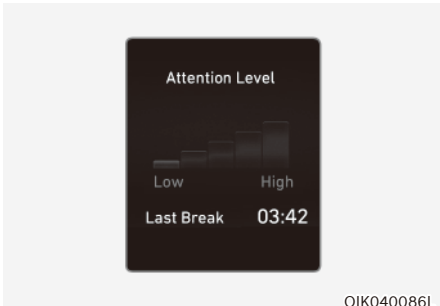

OJK040086L

Attention level

The driver's attention level is shown based on the driver's driving pattern.

For more details, refer to "Driver Attention Warning (DAW)" section in chapter 7.

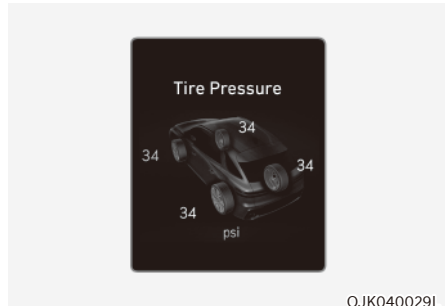

OJK040029L

Tire pressure / Tyre pressure

The tire pressure of each tire is displayed.

For more details, refer to "Tire Pressure Monitoring System (TPMS)" section in chapter 8.

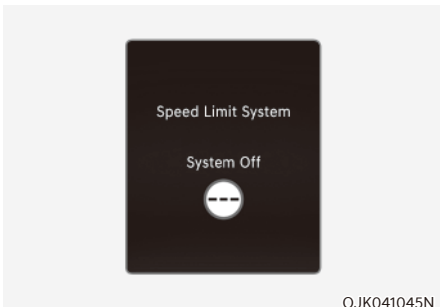

OJK041045N

Speed limit system (if equipped)

The driver can monitor the information provided from Intelligent Speed Limit Assist.

For more details, refer to "Intelligent Speed Limit Assist (ISLA)" section in chapter 7.



OJK040056

Driving force distribution (AWD)

The distribution status of the driving power of the front and rear wheels are displayed when Auto AWD mode is activated.

For more details, refer to "All Wheel Drive (AWD)" section in chapter 6.

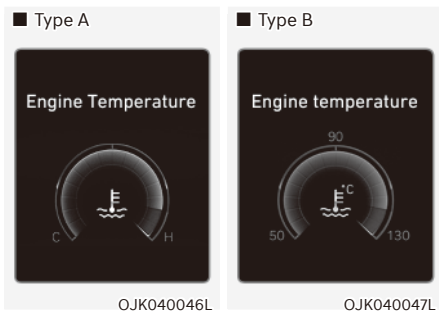

Engine temperature (for 8-inch cluster)

Engine coolant temperature gauge display shows the temperature of the engine coolant when the engine is running.

* For 12.3-inch 3D instrument cluster, you can check the engine temperature in the bottom right side of the cluster.

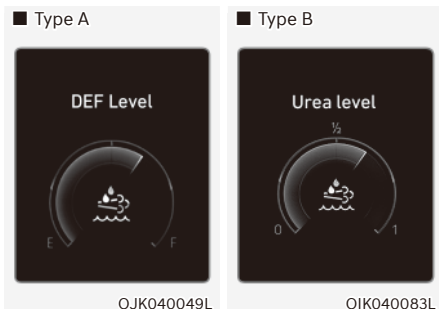

DEF level / Urea level (for diesel engine, if equipped)

DEF (Diesel Exhaust Fluid) level gauge display shows the amount of the remaining urea solution in the urea solution tank.

For more details, refer to "Urea Solution Purity" section in chapter 9.

Select contents / Contents configuration

You can select the items to be displayed in Utility view.

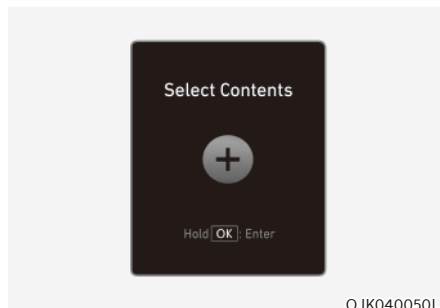

1. Press and hold the OK switch on the steering wheel.

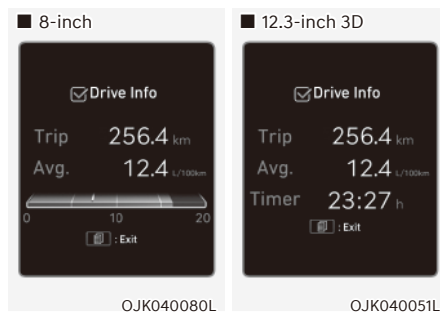

2. Use the \wedge , \vee (UP, DOWN) switch to change items, and press the OK switch to select or deselect the item.
3. After selecting the items to be displayed in the Utility view, press the MODE button to exit the 'Select Contents' display.



WARNING

To avoid driver distractions, do not adjust the setting while driving the vehicle which may lead to an accident.

Additional information display

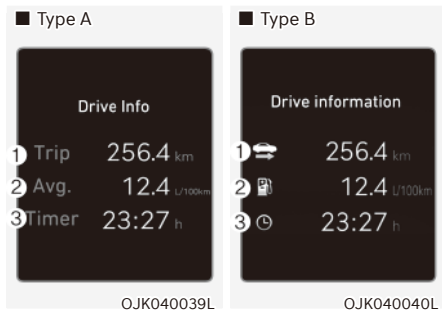

Drive info / Drive information

Drive information is displayed for 4 seconds after the engine is turned off.



Driving assist information

The current operation conditions of Manual Speed Limit Assist, Cruise Control, Smart Cruise Control, Lane Following Assist, Highway Driving Assist, etc. is displayed.

Option menu

Press the OK switch to enter Option menu.

WARNING

To avoid driver distractions, do not adjust the setting while driving which may lead to an accident.

Information

The information provided may differ depending on which features are applicable to your vehicle.

Menu	Explanation
Service messages	To check vehicle warning messages.
3D cluster / 3D effect (for 12.3-inch 3D cluster)	To activate or deactivate 3D effect.
Head-up display	To activate or deactivate head-up display.
Driver assistance settings	To directly display "Driver Assistance" menu on the infotainment system screen
Speed unit	To set speed unit between km/h and MPH.

Service messages

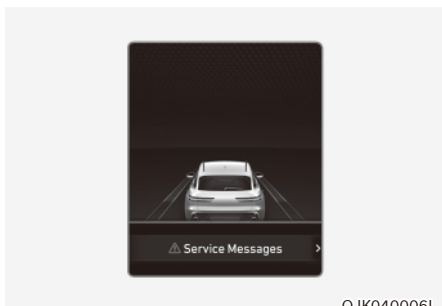

OJK040006L

When Service Messages menu is selected, press the OK switch on the steering wheel to check vehicle warning messages.

3D cluster / 3D effect (for 12.3-inch 3D cluster)

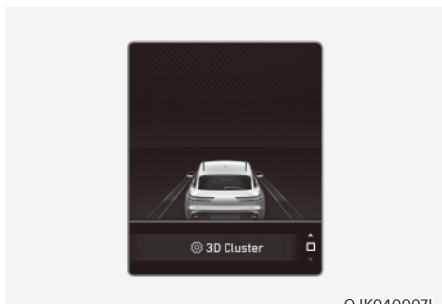

OJK040007L

When 3D Cluster (3D effect) menu is selected, press the OK switch on the steering wheel. You may select or deselect 3D cluster effect by pressing the OK switch.

Head-up display (if equipped)

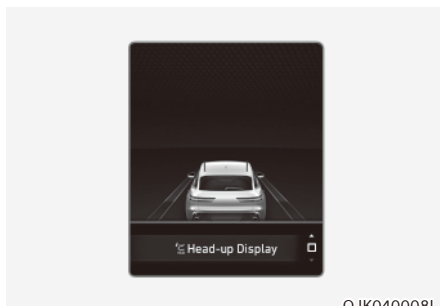

OJK040008L

When Head-Up Display menu is selected, press the OK switch on the steering wheel. You can select or deselect head-up display by pressing the OK switch.

Driver Assistance settings

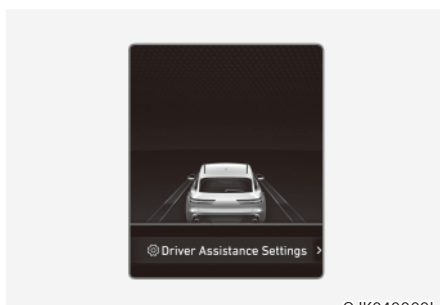

OJK040009L

When Driver Assistance Settings menu is selected, press the OK switch on the steering wheel. The 'Driver Assistance' menu will be displayed on the infotainment system screen.

Speed unit (if equipped)

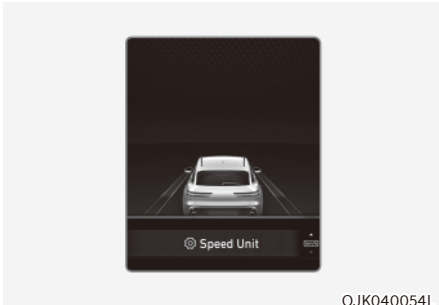

When the Speed Unit menu is selected, press the OK switch on the steering wheel. You can change the speed unit setting between km/h and MPH for the cluster.

3D instrument cluster (for 12.3-inch 3D cluster)

3D cluster setting

To use the 3D cluster, press the Engine Start/Stop button to the ON position, and then select 'Setup → Vehicle Settings → Cluster → 3D Cluster Depth → Normal/Light' in infotainment system screen.

To use the cluster 2D, select 'Off'.

For detailed information, scan the QR code in the separately supplied simple manual.

Recommendations to optimize the 3D effect

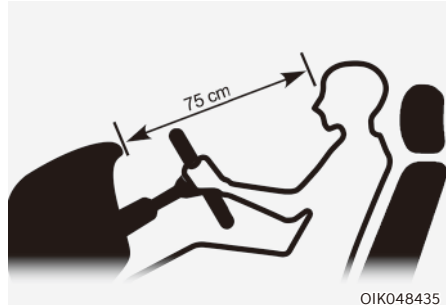

- Adjust the height of the seat and steering wheel so that the instrument cluster and camera module can be seen at a glance.
- The optimal distance to maximize the 3D effect is 75 cm (30 inches). Adjust the distance between the driver's seat and the instrument cluster.
- Hold the steering wheel with both hands and drive in an upright position.

i Information

- **When your face gets too close or far to the instrument cluster, or the camera on the instrument cluster is blocked by the steering wheel or other objects, the 3D cluster changes to 2D automatically. However if the object blocking the camera is removed, the cluster changes back to 3D automatically.**
- **If outside temperature is below 4°C (39°F), it may change to 2D about 1 to 10 minutes.**

- Two red lights may appear on the camera in the following conditions when:
 - The outside brightness is dim or driving at night
 - The vehicle drives inside a building, such as a basement parking lot
 - The camera case of the instrument cluster is partially damaged



CAUTION

- It may sometimes be difficult to read information on the 3D cluster in the following situations. You must change the cluster to 2D for safe driving.
 - The driver is wearing sunglasses, special glasses, infrared cutoff glasses, refracting glasses or thick glasses
 - The driver has heavy eye makeup (eyeliner, mascara, color makeup, false eyelash) or eye piercing
 - The driver's view is blocked by his/her hair, etc.
 - The driver is winking or wearing an eye patch on one eye
 - The driver's face is covered partially by a mask, muffler, hijab, etc.
 - The driver's view is blocked by incoming light from outside of the vehicle
 - Light from outside, sunlight or infrared LED light of the camera is reflected on the glasses or sunglasses
 - The driver turns or lowers his/her head so that the face or an eye is hidden from the camera
- The driver shakes his/her head up and down, or adverse road conditions cause excessive vehicle vibrations while driving
- The driver is too tall or short
- More than two people are looking at the instrument cluster simultaneously from the driver's seat
- The driver's eyesight of both eyes are severely different
- The driver has a severe headache
- Do not look toward the camera within 20 cm (8 inches) for longer than a minute.
- If you use the 3D cluster while your vehicle is stopped, it can cause eye strains or dizziness.
- We recommend people who are pregnant, elderly or has motion sickness, avoid using the cluster in 3D.

⚠ WARNING

- You should not use the 3D cluster if you or any of your family members or relatives has a history of epilepsy, convulsions, etc. Flashing or flickering lights or specific or regular patterns shown on the cluster may stimulate epilepsy, convulsions, etc.
- You should not use the 3D effect immediately if you feel any of the following symptoms:
Haziness, unconsciousness, disorientation, nausea, headache, fatigue, dizziness, etc.

⚠ WARNING

While replacing the instrument cluster by yourself, be cautious of the heat from the top and backside of the instrument cluster.

NOTICE

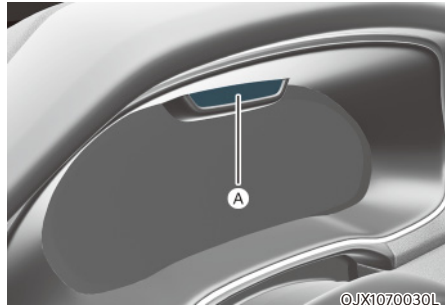

[A] : Camera

- Do not apply any impact on the surface of the instrument cluster, camera or around the area of the camera. If the camera is damaged, the system may not operate properly.
- Do not place a mobile phone or an object in front of the camera. The surface of the instrument cluster or the camera might be damaged due to an impact while driving.
- Do not place anything on the camera or in front of the camera while driving. The camera may not operate properly.
- When cleaning the instrument cluster or camera, wipe with a soft and clean cloth to prevent damages on the surface of the cluster or camera lens. In addition, you should not use sharp tools near the cluster or camera, or use chemicals to clean the cluster or camera.
- Always keep the camera clean and dry.

VEHICLE SETTINGS (INFOTAINMENT SYSTEM)



OJK040010L

Vehicle Settings in the infotainment system provides user options for a variety of settings including door lock/unlock features, convenience features, driver assistance settings, etc.

Vehicle Settings menu

- Driver Assistance
- Drive Mode
- Active Sound Design
- Head-Up Display
- Cluster
- Climate
- Seat
- Lights
- Door/Tailgate
- Convenience

The information provided may differ depending on which features are applicable to your vehicle.



WARNING

Do not operate the Vehicle Settings while driving. This may cause distraction resulting in an accident.

Setting your vehicle

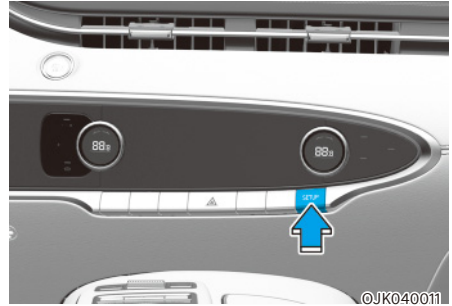

©JJK040011

1. Press the SETUP button on the head unit of the infotainment system.

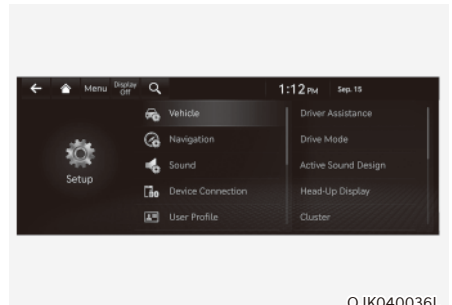

OJK040036L

2. Select 'Vehicle' and change the setting of the features.

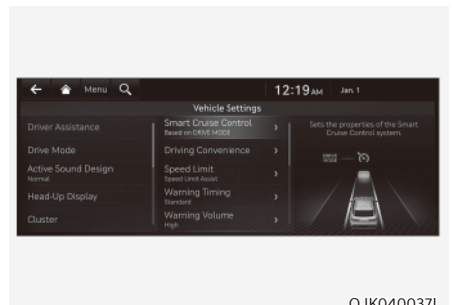

OJK040037L

For detailed information, scan the QR code in a separately supplied simple manual.

5. Convenience features

Accessing your vehicle	5-5
Smart key	5-5
Immobilizer system	5-11
Fingerprint authentication system	5-12
Fingerprint authentication system settings	5-12
Fingerprint authentication system operation	5-13
Limitations of the system	5-14
Used vehicle	5-14
Door locks.....	5-15
Operating door locks from outside the vehicle.....	5-15
Operating door locks from inside the vehicle	5-16
Deadlocks	5-19
Automatic door lock and unlock features	5-19
Child-protector rear door locks.....	5-20
Electronic child safety lock.....	5-20
Theft-alarm system.....	5-22
Advanced Rear Occupant Alert (ROA)	5-23
Declaration of Conformity.....	5-25
Integrated memory system.....	5-26
Storing memory positions	5-26
Recalling memory positions.....	5-27
Resetting the system	5-27
Seat easy access	5-28
Steering wheel	5-29
Electric Power Steering (EPS).....	5-29
Tilt/Telescopic steering.....	5-30
Horn.....	5-31
Heated steering wheel.....	5-32
Mirrors	5-33
Inside rearview mirror.....	5-33
Outside rearview mirrors	5-34
Reverse parking aid.....	5-36
Windows.....	5-38
Power windows	5-40

Panorama sunroof.....	5-43
Sunshade	5-44
Sliding the sunroof	5-45
Tilting the sunroof.....	5-45
Closing the sunroof.....	5-46
Resetting the sunroof	5-47
Sunroof open warning	5-48
Exterior features.....	5-48
Hood.....	5-48
Power tailgate.....	5-49
Smart tailgate	5-56
Fuel filler door.....	5-58
Head-Up Display (HUD).....	5-61
Head-up display settings.....	5-61
Head-up display information	5-61
Precautions while using the head-up display	5-62
Lighting.....	5-63
Exterior lights.....	5-63
Interior lights	5-67
Welcome system	5-71
Intelligent Front-Lighting System (IFS)	5-72
Intelligent Front-Lighting System settings.....	5-72
Intelligent Front-Lighting System operation	5-72
Intelligent Front-Lighting System malfunction and limitations.....	5-73
High Beam Assist (HBA)	5-76
High Beam Assist settings.....	5-76
High Beam Assist operation	5-77
High Beam Assist malfunction and limitations.....	5-77
Wipers and washers.....	5-79
Front windshield wipers.....	5-79
Front windshield washers.....	5-81
Rear window wiper and washer	5-82
Automatic climate control system.....	5-83
Automatic temperature control mode.....	5-85
Manual temperature control mode.....	5-86
System operation	5-95
System maintenance	5-97

5. Convenience features

Windshield defrosting and defogging.....	5-99
To defog inside windshield	5-99
To defrost outside windshield	5-100
Defogging logic	5-100
Rear window defroster	5-101
Climate control additional features.....	5-102
Auto defogging system.....	5-102
Auto dehumidify	5-103
Recirculating air when washer fluid is used.....	5-104
Sunroof inside air recirculation	5-104
Auto. Controls That Use Climate Control Settings (for driver's seat)	5-104
Storage compartment	5-105
Center console storage.....	5-105
Glove box	5-105
Sunglass holder	5-106
Mobile phone holder.....	5-106
Interior features	5-107
Cup holder	5-107
Ashtray	5-108
Sunvisor	5-108
Power outlet	5-109
USB charger.....	5-110
AC Inverter.....	5-111
Wireless smart phone charging system.....	5-112
Clock	5-114
Coat hook.....	5-114
Floor mat anchor(s).....	5-115
Rear side window sunshades.....	5-116
Luggage net holder.....	5-116
Cargo security screen	5-117
Exterior features.....	5-119
Roof side rails	5-119

Infotainment system.....	5-120
USB Port.....	5-120
Antenna.....	5-120
Steering wheel remote controls.....	5-120
Infotainment system.....	5-121
Voice recognition.....	5-121
Bluetooth® Wireless Technology.....	5-122
Lexicon premium sound system.....	5-122
Built-in cam.....	5-123
Built-in Cam's settings.....	5-123
Built-in Cam operation.....	5-124
Built-in Cam screen.....	5-126

ACCESSING YOUR VEHICLE

Smart key

■ Type A



OJX1059252L

■ Type B

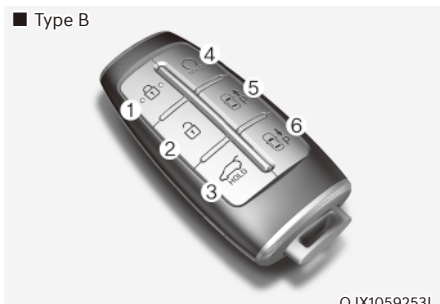

OJX1059253L

Your Genesis Branded Vehicle uses a Smart Key, which you can use to lock or unlock the driver and passenger doors or the rear tailgate.

1. Door lock
2. Door unlock
3. Tailgate open/close
4. Remote start
5. Forward
6. Backward

Locking your vehicle

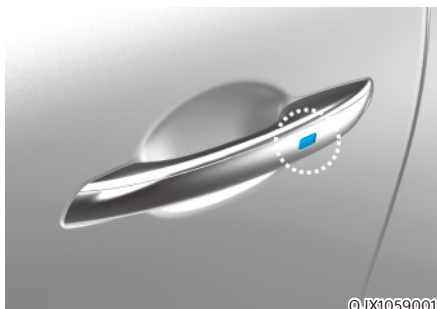

OJX1059001

To lock your vehicle using the door handle touch sensor or the Smart Key:

1. Make sure all doors, the hood and the tailgate are closed.
2. Make sure you have the smart key in your possession.
3. Touch the touch sensor on the door handle (the engraved part) or press the Door Lock button (1) on the smart key. The hazard warning lights will blink.
4. Make sure the doors are locked by pulling the door handle.

i Information

- **The outside rearview mirror will fold if 'Enable on Door Unlock' is selected from the Settings menu in the infotainment system screen. Select:**
 - Setup → Vehicle Settings → Convenience → Welcome Mirror/Light → Enable on Door Unlock
- **The door handle touch sensor will only operate when the smart key is within 0.7~1 m (28~40 in.) from the outside door handle.**
- **Touching the door handle touch sensor does not unlock the doors. To unlock the doors, refer to the following page.**

Note that you cannot lock your vehicle using the door handle touch sensor if any of the following occur:

- The Smart Key is in the vehicle.
- The Engine Start/Stop button is in ACC or ON position.
- Any of the doors are open except for the tailgate.



WARNING

Do not leave the Smart Key in your vehicle with unsupervised children. Unattended children could press the Engine Start/ Stop button and may operate power windows or other controls, or even make the vehicle move, which could result in serious injury or death.

Unlocking your vehicle

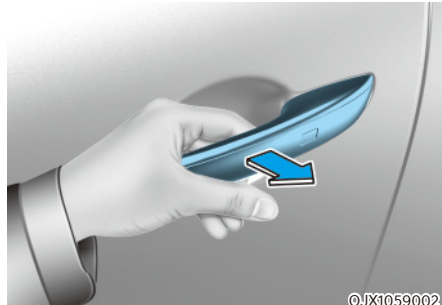

To unlock your vehicle using the door handle touch sensor or the Smart Key:

1. Make sure you have the smart key in your possession.
2. Put your hand in the door handle or press the Door Unlock button (2) on the smart key. All doors will unlock and the hazard warning lights will blink two times.
3. After unlocking the doors, the doors will automatically re-lock after 30 seconds unless a door is opened.

i Information

- The outside rearview mirror will unfold if 'Enable on Door Unlock' is selected from the Settings menu in the infotainment system screen. Select:
 - Setup → Vehicle Settings → Convenience → Welcome Mirror/Light → Enable on Door Unlock
- The door handle touch sensor will only operate when the smart key is within 0.7~1 m (28~40 in.) from the outside door handle.
- The doors may lock or unlock if the touch sensor of the outer door handle is recognized while washing your car or due to heavy rain.
- To prevent unintentional door lock or unlock:

Press the lock button on the smart key and immediately press the unlock button along with the lock button for more than 4 seconds. The hazard warning lights will blink four times. At this time, the doors will not lock or unlock even though the touch sensor is touched on the outside door handle.

To deactivate the function, press the door lock or unlock button on the smart key.
- The doors may not lock or unlock in the following situations.
 - If the touch sensor is touched with gloves on
 - If the door is suddenly approached

Opening the tailgate

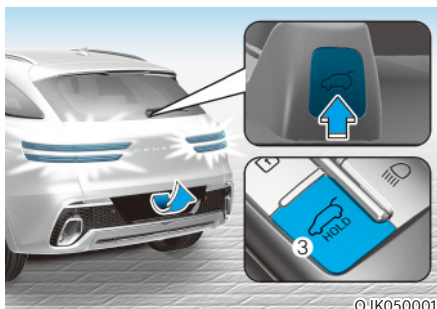

To open the tailgate:

1. Make sure you have the smart key in your possession.
2. Press either the tailgate open/close button on the vehicle or press and hold the Tailgate Unlock button (3) on the smart key for more than one second. The hazard warning lights will blink two times and the tailgate will open.

i Information

The tailgate open/close button will only operate when the smart key is within 0.7 m (28 in.) from the tailgate.

Remotely starting vehicle (if equipped)

You can start the vehicle using the Remote Start button (4) on the smart key.

To start the vehicle remotely:

1. Press the door lock button on the smart key within 10 m (32 feet) from the vehicle.
2. Press the Remote Start button (4) for more than 2 seconds within 4 seconds after pressing the door lock button.
3. The engine will start.
4. To turn off the remote start function, press the Remote Start button (4) once.

i Information

- The vehicle must be in P (Park) for the remote start function to start.
- The engine turns off if you get on the vehicle without a registered smart key.
- The engine turns off if you do not get on the vehicle within 10 minutes after remotely starting the vehicle.
- The Remote Start button (4) may not operate if the smart key is not within 10 m (32 feet).
- The vehicle will not remotely start if the engine hood or tailgate is opened.
- Do not idle the engine for a long period.
- Do not operate remote start in closed areas where there is no adequate ventilation for the engine exhaust.

Remotely moving vehicle forward or backward (if equipped)

With the smart key, the driver can move the vehicle forward or backward using the Forward or Backward button (5, 6) on the smart key.

For more details, refer to “Remote Smart Parking Assist (RSPA)” section in chapter 7.

Start-up

You can start the vehicle without inserting the key.

For more details, refer to the “Engine Start/Stop Button” section in chapter 6.

i Information

If the smart key is not moved for some time, the detection function for smart key operation will pause. Lift the smart key to activate the detection again.

NOTICE

To prevent damaging the smart key:

- Keep the smart key in a cool, dry place to avoid damage or malfunction. Exposure to moisture or high temperature may cause the internal circuit of the smart key to malfunction which may not be covered under warranty.
- Avoid dropping or throwing the smart key.
- Protect the smart key from extreme temperatures.

Mechanical key

If the Smart Key does not operate normally, you can lock or unlock the driver's door by using the mechanical key.

To remove the mechanical key from the smart key FOB:



OJX1059007

1. Place a soft cloth over the groove (A), and using a flat-head screw driver pry open the smart key cover.

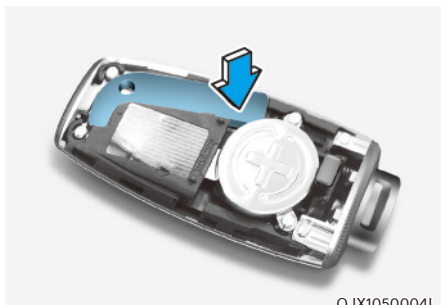

OJX1050004L

2. Press the mechanical key and remove it from the smart key FOB.
3. After use, reinstall the mechanical key and smart key cover in the reverse order of removal.

Loss of a smart key

A maximum of three Smart Keys can be registered to a single vehicle. If you happen to lose your smart key, it is recommended that you should immediately take the vehicle and remaining keys to your authorized retailer of Genesis Branded products or tow the vehicle, if necessary.

Smart key precautions

The smart key may not work if any of the following occur:

- The smart key is close to a radio transmitter such as a radio station or an airport which can interfere with normal operation of the transmitter.
- The smart key is near a mobile two way radio system or a mobile phone.
- Another vehicle's smart key is being operated close to your vehicle.

If the smart key does not work correctly, open and close the door with the mechanical key. If you have a problem with the smart key, it is recommended to contact an authorized retailer of Genesis Branded products.

If the smart key is in close proximity to your mobile phone, the signal could be blocked by your mobile phone's normal operational signals. This is specifically relevant when the phone is active such as making and receiving calls, text messaging, and/or sending/receiving emails. When possible, avoid keeping the smart key and your mobile phone in the same location such as a pants or jacket pocket in order to avoid interference between the two devices.

NOTICE

- Keep the smart key away from electromagnetic materials that blocks electromagnetic waves to the key surface.
- Always have the smart key with you when leaving the vehicle. If the smart key is left near the vehicle, the vehicle battery may be discharged.

Battery replacement

If the Smart Key is not working properly, try replacing the battery with a new one.

Battery Type: CR2032

To replace the battery:

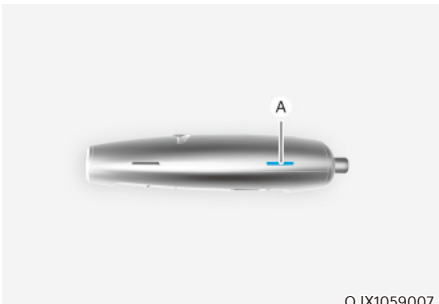

OJX1059007

1. Place a soft cloth over the groove (A), and using a flat-head screwdriver pry open the smart key cover.



OJX1059008

2. Remove battery cover using a phillips screwdriver.
3. Remove the old battery and insert the new battery. Make sure the battery position is correct.
4. Reinstall the battery cover and smart key cover in the reverse order of removal.

If you suspect your smart key might have sustained some damage, or you feel your smart key is not working correctly, it is recommended that you contact an authorized retailer of Genesis Branded products.

 **WARNING**

THIS PRODUCT CONTAINS A BUTTON BATTERY.

If swallowed, a lithium button battery can cause severe or fatal injuries within 2 hours. Keep batteries out of reach of children.

If you think batteries may have been swallowed or placed inside any part of the body, seek immediate medical attention.

 **Information**



An inappropriately disposed battery can be harmful to the environment and human health. Dispose of the battery according to your local law(s) or regulations.

Immobilizer system

The immobilizer system helps protect your vehicle from theft. If an improperly coded key (or other device) is used, the engine's fuel system is disabled.

When the Engine Start/Stop button is pressed to the ON position, the immobilizer system indicator should come on briefly, then go off. If the indicator starts to blink, the system does not recognize the coding of the key.

Press the Engine Start/Stop button to the OFF position, then press the Engine Start/Stop button to the ON position again.

In some circumstances, the vehicle may not recognize your smart key if another smart key device is nearby or a metal object such as a key chain is causing interference with the smart key.

If this occurs, your vehicle may not start. Remove any metal objects or additional keys near the smart key before attempting to start the vehicle again.

If the system repeatedly does not recognize the coding of the key, it is recommended that you contact an authorized retailer of Genesis Branded products.

Do not attempt to alter this system or add other devices to it. Electrical problems could result that may make your vehicle inoperable.



WARNING

In order to prevent theft of your vehicle, do not leave spare keys anywhere in your vehicle. Your immobilizer password is a customer unique password and should be kept confidential.

NOTICE

The transponder in your key is an important part of the immobilizer system. It is designed to give years of trouble-free service, however you should avoid exposure to moisture, static electricity and rough handling. Immobilizer system malfunction could occur.

FINGERPRINT AUTHENTICATION SYSTEM (IF EQUIPPED)

Fingerprint authentication system allows the driver to have access to personal information, unlock profile and exit valet mode with a enrolled fingerprint.

Fingerprint authentication system settings

To use the system, the driver's fingerprint should be enrolled in the driver's profile. The drivers can set or delete their fingerprint through the infotainment system. Follow the following procedure.

Enrolling fingerprint

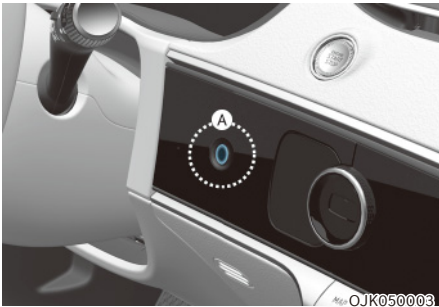

[A] : Fingerprint sensor

1. Turn on the vehicle.
2. Select 'Setup → User Profile Settings → Driver 1 → Fingerprint Identification → Set/Delete Fingerprint → Set' in the infotainment system screen.
3. Place your finger that you wish to enroll on the fingerprint sensor according to the instruction.
4. Following the instructions, place several parts of your fingerprint until the scanning process is complete.
5. Once the scanning process is completed, the message 'Saving fingerprint...!' appears and the fingerprint enrollment process is proceeded.

6. When the fingerprint enrollment process is completed in the vehicle, the status is displayed on the infotainment system.

Deleting fingerprint

1. Select 'Setup → User Profile Settings → Driver 1 → Fingerprint Identification → Set/Delete Fingerprint → Delete' in the infotainment system.
2. Delete the enrolled fingerprint according to the message 'Delete all Driver 1 fingerprints?'
3. Once the fingerprint is deleted, the status is displayed on the infotainment system screen.

i Information

- If no fingerprint is enrolled in the infotainment system, the sensor will not operate.
- The maximum of two fingerprint can be enrolled. Driver 1 and Driver 2 can enroll one fingerprint each.
- Please remove all substances including protection film on the fingerprint sensor and enroll your fingerprint.
- The fingerprint enrollment process is cancelled when the following condition occurs:
 - The infotainment system screen is altered.
 - The Engine Start/Stop button turns on or off.
 - The gear is shifted and the vehicle is driven.

**CAUTION**

Do not participate in duplicating your fingerprint with anyone.

NOTICE

Touch the fingerprint authentication sensor gently. Fingerprint authentication attempts with excessive force may fail.

Fingerprint authentication system operation

Touch control

The convenient features such as personal information access, profile unlock, and valet mode exit are available with the fingerprint authentication system.

When the fingerprint shape appears on the infotainment system screen, you should place your finger on the recognition sensor in the vehicle according to the instruction message for authorization and then you can operate the linked features without entering the password.

If the fingerprint authentication system does not work, pull your finger away from the fingerprint authentication sensor and then try again.

Fingerprint linked features can be turned on or off from the Settings menu. Select:

- 'Setup → User Profile Settings → Driver 1 (or Driver 2) → Fingerprint Identification

Fingerprint linked features	Characteristic
Personal information access	Use with a fingerprint without a password
Profile unlock	
Valet mode exit	

For detailed information, scan the QR code in the separately supplied simple manual.

**Information**

You cannot link a profile with the same fingerprint for Driver 1 and Driver 2. The personalization function works with the recently linked profile, and the previously linked profile will be automatically cancelled.

Limitations of the system

- Fingerprint authentication system may not work when:
 - Trying to authorize with unregistered fingerprint.
 - Not touching the center of fingerprint authentication sensor.
 - Any water or substances is on your finger or the sensor.
 - The film on the sensor is not removed.
 - The registered fingerprint is damaged or swollen.
 - The hand is overly dry.
 - The sensor is touched shortly.
- If fingerprint authentication fails over 5 consecutive times, fingerprint enrollment and deletion may be temporarily restricted. You should try it later or try other methods such as inputting your password.
- When you visit an authorized retailer of Genesis Branded products to repair parts due to fingerprint authorization system or related part failure, your registered fingerprint might be deleted. Have your smart key when you visit an authorized retailer of Genesis Branded products.
- You cannot use the fingerprint sensor when the vehicle is discharged.
- If you turn the engine on or off while proceeding the fingerprint authorization, the process will not be complete.



WARNING

Do not enroll children's fingerprints in the vehicle.

If you enroll children's fingerprints and leave them in the vehicle, unexpected accidents may occur.

Used vehicle

When purchasing a used vehicle

If you purchase a used vehicle, you should confirm and delete all of the enrolled fingerprints in Driver 1 and Driver 2 profile.

DOOR LOCKS

Operating door locks from outside the vehicle

Mechanical key

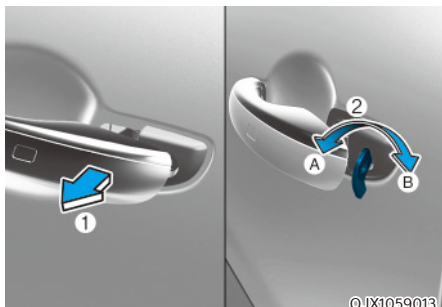

After pulling the door handle (1), turn the key (2) toward the front of the vehicle to lock (A) or turn the key toward the rear of the vehicle to unlock (B).

If you lock the driver's door with a mechanical key, the driver's door will lock. If you unlock the driver's door with a mechanical key, the driver's door will unlock.

Once the doors are unlocked, they may be opened by pulling the door handle. When closing the door, push the door by hand. Make sure that doors are closed securely.

NOTICE

Do not apply excessive force on the door and door handle. It may damage the door and door handle.



Information

When the keyhole freezes and does not open, lightly tap or indirectly warm (for example, hand temperature) the keyhole.

Smart key

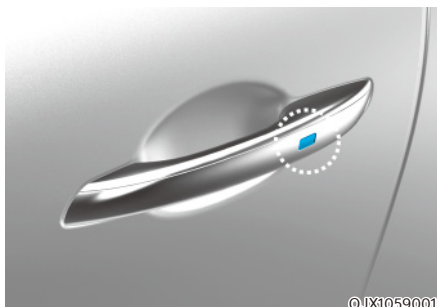

Lock

Touch the touch sensor on the front outside door handle (the engraved part) while carrying the Smart Key with you or press the Door Lock button on the Smart Key, all doors will lock.

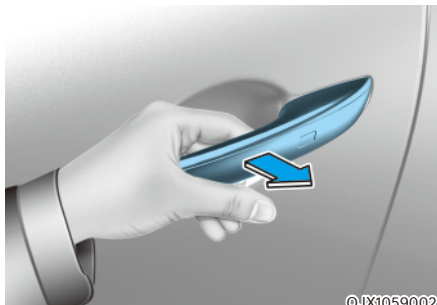

Unlock

Put your hand in the front outside door handle while carrying the Smart Key with you or press the Door Unlock button on the Smart Key, all doors will unlock.

Once the doors are unlocked, they may be opened by pulling the door handle.

When closing the door, push the door by hand. Make sure that doors are closed securely.

For more details, refer to "Smart Key" in the previous pages.

i Information

- In cold and wet climates, door lock and door mechanisms may not work properly due to freezing conditions.
- If the door is locked/unlocked multiple times in rapid succession with either the vehicle key or door lock switch, the system may stop operating temporarily in order to protect the circuit and prevent damage to system components.

Operating door locks from inside the vehicle

With the door handle

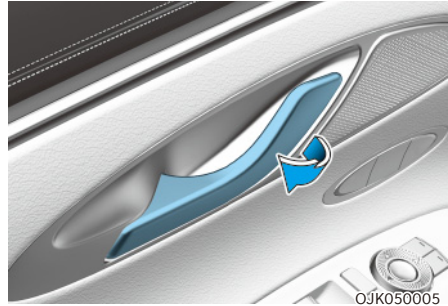

Front door

If the inner door handle is pulled when the door is locked, the door will unlock and open.

Rear door

If the inner door handle is pulled once when the door is locked, the door will unlock. If the inner door handle is pulled once more, the door will open.

i Information



If a power door lock ever fails to function while you are in the vehicle try one or more of the following techniques to exit:

- Operate the door unlock feature repeatedly (both electronic and manual) while simultaneously pulling on the door handle.
- Operate the other door locks and handles, front and rear.
- Lower a front window and use the mechanical key to unlock the door from outside.

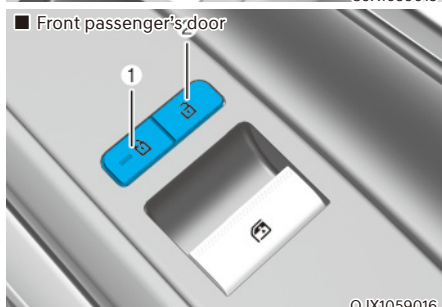
With the central door lock switch



Driver and passenger door

The driver and passenger side door armrest is equipped with a central door lock switch. The lock switch is indicated by a  symbol. The unlock switch is indicated by a  symbol.

When the lock switch (1) is pressed (door indicator light ON), all the vehicle doors will lock.

When the unlock switch (2) is pressed, all the vehicle doors will unlock.

If the smart key is in the vehicle and any door is open, the doors will not lock even though the lock switch (1) is pressed.

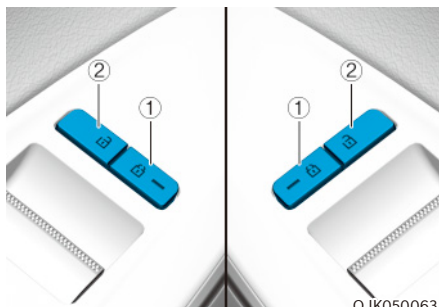

Rear door

When the lock switch (1) is pressed (door indicator light ON), all the vehicle doors will lock.

When the unlock switch (2) is pressed, all the vehicle doors will unlock.

Information

If all doors are locked with the rear door lock switch, and the electronic child safety lock button (if equipped) in the driver's seat is turned ON (indicator light ON), the rear doors cannot be opened. If you want to open the rear doors:

- **Unlock the door with the smart key from outside when the vehicle is in OFF position.**
- **Press the electronic child safety lock button on the driver's door to turn it off (indicator light OFF), then unlock the doors with the driver's or passenger's central door lock switch. (Electronic child lock OFF → Door unlocked)**
- **Press the electronic child safety lock button on the driver's door to turn it off (indicator light OFF), then pull the rear inner door handle twice.**

In case of an emergency



In case of emergency such as when the battery is discharged, the only way to lock the door(s) is with the mechanical key from the outside key hole.

Doors without an outside key hole can be locked as follows:

1. Open the door.
2. Insert the key into the emergency door lock hole and turn the key to the lock position.
3. Close the door securely.

i Information

If the electrical power door lock switch does not operate (for example, dead car battery) and the tailgate is closed, you will not be able to open the tailgate until power is restored.

! WARNING

- The doors should always be fully closed and locked while the vehicle is in motion. If the doors are unlocked, the risk of being thrown from the vehicle in a crash is increased.
- Do not pull the inner door handle of the driver's or passenger's door while the vehicle is moving.

! WARNING

Do not leave children or animals unattended in your vehicle. An enclosed vehicle can become extremely hot, causing death or serious injury to unattended children or animals who cannot escape the vehicle. Children might operate features of the vehicle that could injure them, or they could encounter other harm, possibly from someone gaining entry to the vehicle.

! WARNING

Always secure your vehicle.

Leaving your vehicle unlocked increases the potential risk to you or others from someone hiding in your vehicle.

To secure your vehicle, while depressing the brake, shift the gear to the P (Park) position, engage the parking brake, and press the Engine Start/Stop button to the OFF position, close all windows, lock all doors, and always take the key with you.



CAUTION

Opening a door when something is approaching may cause damage or injury. Be careful when opening doors and watch for vehicles, motorcycles, bicycles or pedestrians approaching the vehicle in the path of the door.



WARNING

If you stay in the vehicle for a long time while the weather is very hot or cold, there are risks of injuries or danger to life. Do not lock the vehicle from the outside when someone is in the vehicle.

Deadlocks (if equipped)

Some vehicles are equipped with a deadlock system. Deadlocks prevent opening of a door from either inside or outside the vehicle once the deadlocks have been activated providing an additional measure of vehicle security.

To lock the vehicle using the deadlock function, the doors must be locked by using the smart key. To unlock the vehicle, the smart key must be used again.

Automatic door lock and unlock features

Your vehicle is equipped with features that will automatically lock or unlock your vehicle based on settings you select in the infotainment system screen.

Auto LOCK Enable on speed

When this feature is set in the infotainment system screen, all the doors will be locked automatically when the vehicle exceeds 15 km/h (9 mph).

Auto UNLOCK Vehicle off

When this feature is set in the infotainment system screen, all the doors will be unlocked automatically when the vehicle is turned off.

For more details, on these features, scan the QR code in a separately supplied simple manual.

Additional unlock safety feature air bag deployment

As an additional safety feature, all doors will be automatically unlocked when an impact causes the air bags to deploy.

Child-protector rear door locks (if equipped)



The child safety lock is provided to help prevent children seated in the rear from accidentally opening the rear doors. The rear door safety locks should be used whenever children are in the vehicle.

The child safety lock is located on the edge of each rear door. When the child safety lock is in the lock position, the rear door will not open if the inner door handle is pulled.

To lock the child safety lock, insert a small flat blade tool (like a screwdriver or similar) (1) into the slot and turn it to the lock position as shown.

To allow a rear door to be opened from inside the vehicle, unlock the child safety lock.



WARNING

If children accidentally open the rear doors while the vehicle is in motion, they could fall out of the vehicle. The rear door safety locks should always be used whenever children are in the vehicle.

Electronic child safety lock (if equipped)

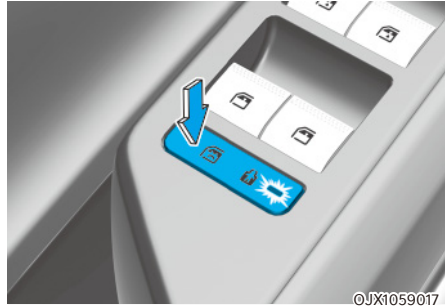

When the electronic child safety lock button is pressed and the indicator light on the button illuminates, the rear doors cannot be opened from inside the vehicle.

- The rear door window cannot be opened or closed while the electronic child safety lock button is in the LOCK position (indicator light ON).

For more details, refer to “Windows” section in this chapter.

- Electronic child safety lock does not automatically turn on unless the driver presses the electronic child safety lock button.
- If 3 minutes passes after the Engine Start/Stop button is pressed to the OFF or ACC, the indicator on the button turns off, and the driver cannot turn off electronic child safety lock by pressing the button. To turn off the function, press the Engine Start/Stop button to the ON position, and then press the electronic child safety lock button.

- If the power is supplied again after removing the battery or battery is discharged while the electronic child safety lock button is in the LOCK position, press the button once more to match the state of the indicator on the electronic child safety lock button and actual status of the electronic child safety lock function.
- If the airbag is activated while the electronic child safety lock button is in the LOCK position (indicator light ON), the rear doors will unlock automatically.
- Vehicles equipped with the electronic child safety lock feature is not provided with a manual child safety lock.



WARNING

If children accidentally opens the rear door while the vehicle is in motion, they could fall out of the vehicle. Electronic child safety lock should always be used whenever children are in the vehicle.

NOTICE

Child safety lock failure / Child safety lock error

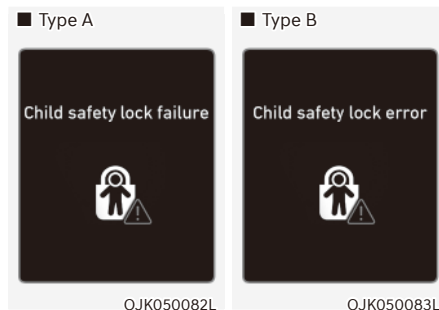

When electronic child safety lock does not work even though the button is pressed, the message will be displayed and an alarm will sound. If this occurs, we recommend that the vehicle be inspected by an authorized retailer Genesis Branded products.

Safe Exit Assist (if equipped with electronic child safety lock)

Safe Exit Assist helps prevent the rear occupant from opening the rear door. When an approaching vehicle from the rear area is detected after the vehicle stops, the rear doors will not unlock even when the driver tries to unlock the rear doors using the electronic child safety lock button.

For more details, refer to “Safe Exit Assist (SEA)” section in chapter 7.

THEFT-ALARM SYSTEM

This system helps to protect your vehicle and valuables. The horn will sound and the hazard warning lights will blink continuously if any of the following occur:

- A door is opened without using the smart key.
- The tailgate is opened without using the smart key.
- The engine hood is opened.

The alarm continues for 30 seconds, then the system resets. To turn off the alarm, unlock the doors with the smart key.

The Theft Alarm System automatically sets 30 seconds after you lock the doors and the tailgate. For the system to activate, you must lock the doors and the tailgate from outside the vehicle with the smart key or by touching the touch sensor on the outside of the door handle with the smart key in your possession.

The hazard warning lights will blink and the chime will sound once to indicate the system is armed.

Once the security system is set, opening any door, the tailgate, or the hood without using the smart key will cause the alarm to activate.

The Theft Alarm System will not set if the hood, the tailgate, or any door is not fully closed. If the system will not set, check the hood, the tailgate, or the doors are fully closed.

Do not attempt to alter this system or add other devices to it.

Information

- **Do not lock the doors until all passengers have left the vehicle. If the remaining passenger leaves the vehicle when the system is armed, the alarm will be activated.**
- **If the vehicle is not disarmed with the smart key, open the doors by using the mechanical key and start the engine by directly pressing the Engine Start/Stop button with the smart key.**
- **If the system is disarmed by unlocking the vehicle, but neither a door or the tailgate is opened within 30 seconds, the doors will relock and the system will rearm automatically.**

Information



Vehicles equipped with a theft alarm system will have a label attached to the vehicle with the following words:

1. **WARNING**
2. **SECURITY SYSTEM**

Advanced Rear Occupant Alert (ROA) (if equipped)

Advanced Rear Occupant Alert is provided to help prevent the driver from leaving the vehicle with the rear passenger left in the vehicle.

System setting

To use Rear Occupant Alert, it must be enabled from the Settings menu in the infotainment system screen. Select:

- Setup → Vehicle Settings → Convenience → Rear Occupant Alert (ROA)

For detailed information, scan the QR code in the separately supplied simple manual.

System operation

- First alert
When you turn off the engine and open the driver's door after opening and closing the rear door or tailgate, the 'Check rear seats' warning message appears on the cluster.
- Second alert
After the first alert, the second alert operates when any movement is detected in the vehicle after the driver's door is closed and all the doors are locked. The hazard warning lights will blink and the horn will sound for approximately 25 seconds. Also, a text message is sent to members of Genesis Connected Services (if available). If the system continues to detect a movement, the alert operates up to 8 times.
Unlock the doors with the smart key to stop the alert.
- The system detects movement in the vehicle for 10 minutes after the door is locked.

i Information

- The second alert is available for vehicles equipped with the ROA sensor.
- The second alert is activated only after the prior activation of the first alert.

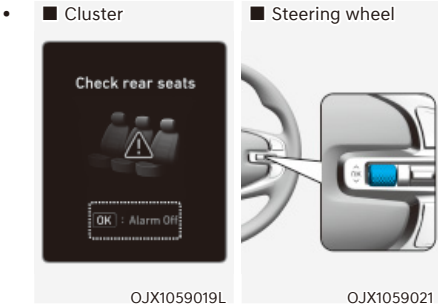

If you do not want to use Rear Occupant Alert, press the OK button on the steering wheel when the first alert is displayed on the cluster. Doing so will deactivate the second alert one time.

- **If the vehicle is started remotely (if equipped with Remote Start), inside movement detection will stop.**

System precautions

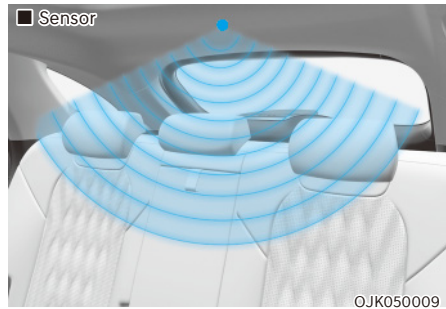

- Make sure that all the windows are closed. If the window is open, the alert may operate by the sensor detecting an unintended movement (for example, wind or bugs).
- The alert may operate if movement in the driver or passenger seat is detected.
- If the doors are locked with a passenger inside the vehicle, the alert may operate.
- An alert can occur if there is an impact on the vehicle.
- If boxes or objects are stacked in the vehicle, the system may not detect passengers. Or, the alert may operate if the boxes or objects fall off.
- The alert may operate when the vehicle is pushed or shaken, or while washed, or by surrounding noise or vibration after the vehicle is locked.
- The alert may operate when there are metallic or liquid objects in the vehicle.



WARNING

Even if your vehicle is equipped with **Advanced Rear Occupant Alert (ROA)**, always make sure to check the rear seat before you leave the vehicle.

Advanced Rear Occupant Alert (ROA) may not operate when:

- Movement does not continue for a certain period of time or the movement is small.
- A child is not seated in a child restraint system.
- Movement is detected in areas other than the rear seats.
- The rear passenger is covered with a fabric containing metallic substance such as a blanket.
- An object in the vehicle blocks the sensor.
- The sensor is contaminated by foreign material.
- An animal at the rear seat or luggage compartment is not large enough to be detected by the sensor or there is hardly any movement.
- Attaching objects or modifying the interior ceiling, or the interior ceiling is deformed or damaged.
- There are electronic interference around the vehicle.
- Other environmental reasons that may affect the system.

Declaration of Conformity

The radio frequency components (ROA Radar Sensor) complies:

- For Europe and CE certified countries

Declaration of Conformity
Radiocontrolled Vehicle components



Hereby, APTIV, 42367 Wuppertal declares that this J4TR/J4TRh is in compliance with the essential requirements and other relevant provisions of Directive 2014/53/EU (RED).

The original declaration of conformity can be accessed at the following link :
www.aptiv.com/automotive-homologation

frequency band 76-77 GHz
Maximum Output Power 30 dBm (1,0 W)

OANATEL332

INTEGRATED MEMORY SYSTEM



Integrated Memory System for the driver's seat is provided to store and recall the following memory settings with a simple button operation.

- Driver's seat position
- Steering wheel position (power adjustment)
- Outside rearview mirror position
- Head-Up Display (HUD) position (if equipped)



WARNING

Never attempt to operate the integrated memory system while the vehicle is moving.

This could result in loss of control, and an accident causing death, serious injury, or property damage.



Information

- **If the battery is disconnected, the memory settings will be erased.**
- **If integrated memory system does not operate normally, we recommend that you have the system inspected by an authorized retailer of Genesis Branded products.**

Storing memory positions

1. Shift to P (Park) while the Engine Start/Stop button is in the ON position.
2. Adjust the driver's seat position, outside rearview mirror position, steering wheel position and head-up display height to the desired position.
3. Press the SET button. The system will beep once and notify you 'Press button to save settings' on the cluster LCD display.
4. Press one of the memory buttons (1 or 2) within 4 seconds. The system will beep twice when the memory has been successfully stored.
5. 'Driver 1 (or 2) settings saved' will appear on the cluster LCD display. The message appears only for the driver's seat position memory setting.

Recalling memory positions

1. Shift to P (Park) while the Engine Start/Stop button is in the ON position.
2. Press the desired memory button (1 or 2). The system will beep once, and then the driver's seat position, outside rearview mirror position, steering wheel position and head-up display height will automatically adjust to the stored positions.
3. 'Driver 1 (or 2) settings applied' will appear on the cluster LCD display.



Information

- **If you press the SET button or the corresponding button which the setting is being recalled, the setting will temporarily deactivate. If you press the other buttons, the setting of the pressed button will activate.**
For example, if you press the SET button or number 1 button with the number 1 setting in operation, the setting will temporarily deactivate. If you press the number 2 button, the number 2 setting will activate.
- **If you adjust the seat, rearview mirror, steering wheel or head-up display while recalling the stored positions, the pre-set settings will become ineffective.**

Resetting the system

Take the following procedures to reset integrated memory system, when it does not operate properly.

Resetting integrated memory system

1. Stop the vehicle and open the driver's door with the Engine Start/Stop button in the ON position and the vehicle shifted to P (Park).
2. Adjust the driver's seat and seatback to the foremost position.
3. Press the SET button and push forward the driver's seat movement switch over 2 seconds simultaneously.

While resetting integrated memory system

1. Resetting starts with a notification sound.
2. The driver's seat and seatback is adjusted to the rearward position with the notification sound.
3. The driver's seat and seatback is re-adjusted to the default position (central position) with the notification sound.

However, in the following cases, the resetting procedure and the notification sound may stop.

- The memory button is pressed.
- The seat control switch is operated.
- The gear is shifted out of P (Park).
- The driving speed exceeds 3 km/h (2 mph).
- The driver's door is closed.

NOTICE

- **While integrated memory system is being reset, if the resetting and notification sound stops incompletely, restart the resetting procedure again.**
- **Make sure that there is no objects around the driver's seat in advance of resetting the integrated memory system.**
- **After resetting the integrated memory system, the adjustment for the driver seat must be stored again to recall the memory position.**

Seat easy access

Seat easy access will move the driver's seat and steering wheel automatically as follows:

- **Exiting the vehicle:**
The driver's seat, steering wheel and seat bolster will move as follows when the Engine Start/Stop button is in the OFF position with the gear in P (Park) and the driver's door open.
 - Driver seat: Moves rearward depending on the distance selected from the Settings menu in the infotainment system.
 - Steering wheel: Moves upward
 - Seat bolster (if equipped): Adjusted to the default position.

However, the driver's seat may not move rearward if there is not enough space between the driver's seat and the rear seats.

Also, on a regular basis, the steering wheel will also move forward to adjust its location by itself.

- **Entering the vehicle:**
The driver's seat, steering wheel and seat bolster will move as follows when the Engine Start/Stop button is pressed to the ACC, ON or START position or while carrying the smart key, the driver's door is closed with the Engine Start/Stop button in the OFF position.
 - Driver seat: Moves back to its original position.
 - Steering wheel: Moves back to its original position.
 - Seat bolster (if equipped): Adjusted to the default position.
- You can set the Seat Easy Access function from the Settings menu in the infotainment system screen. Select:
 - Driver seat
Setup → Vehicle Settings → Seat → Seating Easy Access → Driver Seat Easy Access → Normal/Extended/Off
 - Steering wheel
Setup → Vehicle Settings → Seat → Seating Easy Access → Steering wheel easy access

For detailed information, scan the QR code in the separately supplied simple manual.

STEERING WHEEL

Electric Power Steering (EPS)

The system assists you with steering the vehicle. If the vehicle is turned off or if the power steering system becomes inoperative, you may still steer the vehicle, but it will require increased steering effort.

Should you notice any change in the effort required to steer during normal vehicle operation, we recommend that you have the system checked by an authorized retailer of Genesis Branded products.



CAUTION

If Electric Power Steering does not operate normally, the  warning light and the message 'Check motor driven power steering' will illuminate on the instrument cluster. You may steer the vehicle, but it will require increased steering efforts. We recommend that you take the vehicle to an authorized retailer of Genesis Branded products and have the system checked as soon as possible.

Information

The following symptoms may occur during normal vehicle operation:

- The steering effort may be high immediately after pressing the Engine Start/Stop button to the ON position. This happens as the system performs the EPS system diagnostics. When the diagnostics are completed, the steering wheel effort will return to its normal condition.
- When the battery voltage is low, you might have to put more steering effort. However, it is a temporary condition so that it will return to normal condition after charging the battery.
- A click noise may be heard from the EPS relay after the Engine Start/Stop button is in the ON or OFF position.
- Motor noise may be heard when the vehicle is at a stop or at a low driving speed.
- When you operate the steering wheel in low temperatures, abnormal noise may occur. If the temperature rises, the noise will disappear. This is a normal condition.
- When an error is detected from EPS, the steering effort assist function will not be activated in order to prevent fatal accidents. Instrument cluster warning lights may be on or the steering effort may be high. If these symptoms occur, drive the vehicle to a safe area as soon as it is safe to do so. We recommend that you have the system checked by an authorized retailer of Genesis Branded products as soon as possible.

Tilt/Telescopic steering

When adjusting the steering wheel to a comfortable position, adjust the steering wheel so that it points toward your chest, not toward your face. Make sure you can see the instrument cluster warning lights and gauges. After adjusting, push the steering wheel both up and down to be certain it is locked in position.

Always adjust the position of the steering wheel before driving.

WARNING

NEVER adjust the steering wheel while driving. This may cause loss of vehicle control resulting in an accident.

Manual adjustment

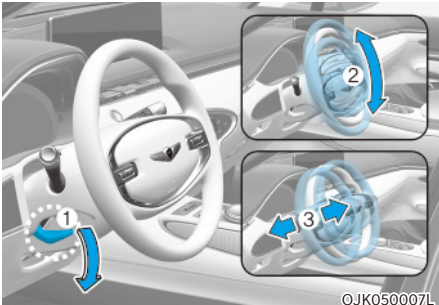

To adjust the steering wheel angle and height:

1. Pull down the lock-release lever (1).
2. Adjust the steering wheel to the desired angle (2) and distance forward/back (3).
3. Pull up the lock-release lever to lock the steering wheel in place.

Information

Sometimes the lock release lever may not engage completely. This may occur when the gears of the locking mechanism do not completely mesh. If this occurs, pull down on the lock-release lever, readjust the steering wheel again, and then pull back up on the release lever to lock the steering wheel in place.

Power adjustment

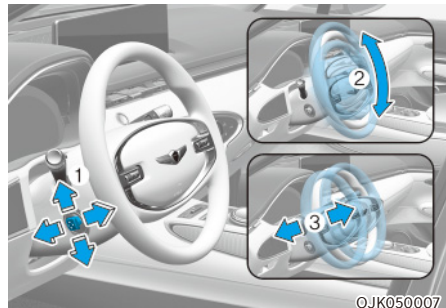

To change the steering wheel angle and height:

- Push the switch (1) up and down to adjust the angle (2).
- Push the switch forward or rearward to adjust the height (3).

NOTICE

Do not adjust the steering wheel longer than necessary when the engine is turned off. This may result in unnecessary battery drain.

Resetting steering wheel power adjustment

If adjustment is no longer possible within the operable range while adjusting the steering wheel position (angle or height), reset as follows.

1. From the position the steering wheel has stopped, push the control switch (1) for 10 seconds in the direction you were adjusting the steering wheel. The steering wheel will move in the direction the control switch is pushed.
2. Continue pushing the switch (1) for at least 2 seconds after the steering wheel has stopped. Resetting will be complete after the operational range is recognized.

If the adjustment is still not possible after resetting the steering wheel power adjustment, we recommend that the system be inspected by authorized retailer of Genesis Branded products.

Horn

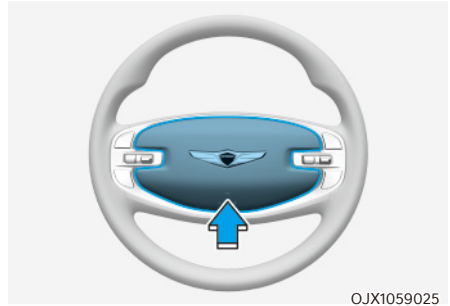

To sound the horn, press the area indicated by the horn symbol on your steering wheel (see illustration). The horn will operate only when this area is pressed.

NOTICE

Do not strike the horn severely to operate it, or hit it with your fist. Do not press on the horn with a sharp-pointed object.

Heated steering wheel (if equipped)

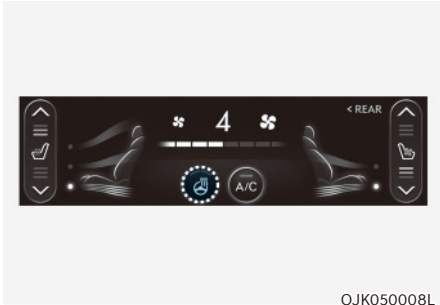

While the engine is running, touch the heated steering wheel icon to warm the steering wheel.

- Manual temperature control
Each time you touch the icon, the temperature setting of the steering wheel changes as follows:



- Automatic temperature control
The heated steering wheel starts to automatically control the steering wheel temperature after being manually turned ON.
 - When HIGH (☀️☀️) is manually selected:
The heated steering wheel automatically changes to the LOW position after 30 minutes. You can turn off the heated steering wheel by touching the icon to the OFF position.
 - When LOW (☀️) is manually selected:
The heated steering wheel will not be controlled manually.

- Auto. Controls That Use Climate Control Settings (for driver's seat)

The heated steering wheel automatically controls the steering wheel temperature depending on the ambient temperature when the engine is running.

If you touch the heated steering wheel icon, the heated steering wheel will have to be controlled manually.

To use this function, it must be enabled from the Settings menu in the infotainment system screen.

Select:

- Setup → Vehicle Settings → Seat → Heated/Ventilated Features → Auto. Controls That Use Climate Control Settings → Heated steering wheel

For detailed information, scan the QR code in the separately supplied simple manual.

- The heated steering wheel defaults to the OFF position whenever the Engine Start/Stop button is pressed to the ON position. However, if the Auto. Controls That Use Climate Control Settings function is ON, the heated steering wheel will turn on and off depending on the outside temperature.

NOTICE

Do not install any cover or accessory on the steering wheel. The cover or accessory could cause damage to the heated steering wheel system.

MIRRORS

Inside rearview mirror

Before driving your vehicle, check to see that your inside rearview mirror is properly positioned. Adjust the rearview mirror so that the view through the rear window is properly centered.

WARNING

Make sure your line of sight is not obstructed. Do not place objects in the rear seat, cargo area, or behind the rear headrests which could interfere with your vision through the rear window.

WARNING

To prevent serious injury during an accident or deployment of the air bag, do not modify the rearview mirror and do not install a wide mirror.

WARNING

NEVER adjust the mirror while driving. This may cause loss of vehicle control resulting in an accident.

NOTICE

When cleaning the mirror, use a paper towel or similar material dampened with glass cleaner. Do not spray glass cleaner directly on the mirror as this may cause the liquid cleaner to enter the mirror housing.

Electric Chromic Mirror (ECM) (if equipped)

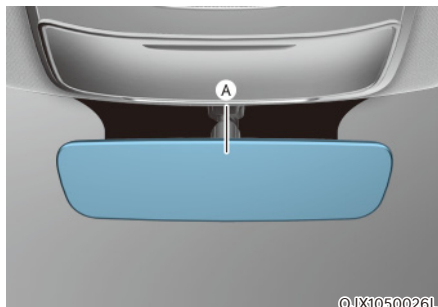

[A] : Indicator

Some vehicles come equipped with an electrochromic mirror that helps control glare while driving at night or under low light driving conditions.

When the engine is running, the glare is automatically controlled by the sensor mounted in the rearview mirror. The sensor detects the light level around the vehicle, and automatically adjusts to control the headlamp glare from vehicles behind you.

Whenever the the gear is shifted to R (Reverse), the mirror will automatically go to the brightest setting in order to improve the driver's view behind the vehicle.

Outside rearview mirrors

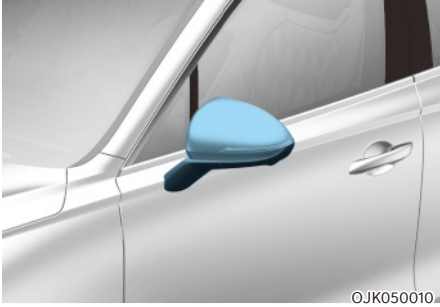

Your vehicle is equipped with both left-hand and right-hand outside rearview mirrors. The mirrors can be adjusted remotely with the mirror adjustment control switch. The outside rearview mirrors can be folded to help prevent damage when going through an automatic car wash or when passing through a narrow street.

The right outside rearview mirror is convex. Objects seen in the mirror are closer than they appear.

Use the inside rear view mirror or look back directly to determine the actual distance of other vehicles prior to changing lanes.

Make sure to adjust the outside rearview mirrors to your desired position before you begin driving.



WARNING

Do not adjust or fold the outside rearview mirrors while driving. This may cause loss of vehicle control resulting in an accident.

NOTICE

- Do not scrape ice off the mirror face; this may damage the surface of the glass.
- If the mirror is jammed with ice, do not adjust the mirror by force. Use an approved spray de-icer (not radiator antifreeze) spray, or a sponge or soft cloth with very warm water, or move the vehicle to a warm place and allow the ice to melt.
- Do not clean the mirror with harsh abrasives, fuel or other petroleum based cleaning products.

Adjusting the rearview mirrors



Adjusting the rearview mirrors:

1. When the Engine START/STOP button is in the ACC, ON or START position, press either the L (Left side) or R (Right side) button (1) to select the rearview mirror you would like to adjust.
2. Use the mirror adjustment control switch (2) to position the selected mirror up, down, left or right.
3. After adjustment, press both L and R button off (indicator light off) to prevent inadvertent adjustment.

NOTICE

- **The mirrors stop moving when they reach the maximum adjusting angles, but the motor continues to operate while the switch is pressed. Do not press the switch longer than necessary, because this can damage the motor.**
- **Do not attempt to adjust the rearview mirrors by hand, because this can damage the motor.**

Folding the rearview mirrors



Folding button

The rearview mirrors can be folded or unfolded by pressing the button.

Infotainment system setting

- Enable on door unlock
If 'Setup → Vehicle Settings → Welcome Mirror/Light → Enable on Door Unlock' is selected from the Settings menu in the infotainment system screen,
 - The mirror will fold or unfold when the door is locked or unlocked by the smart key.
 - The mirror will fold or unfold when the door is locked or unlocked by the touch sensor on the outside door handle.
- Enable on driver approach
If 'Setup → Vehicle Settings → Convenience → Welcome Mirror/Light → Enable on Driver Approach' is selected from the Settings menu in the infotainment system screen, the mirror will unfold when the vehicle is approached with the smart key in possession.

For detailed information, scan the QR code in the separately supplied simple manual.

NOTICE

The electric type outside rearview mirror operates even though the Engine Start/Stop button is in the OFF position. However, to prevent unnecessary battery discharge, do not adjust the mirrors longer than necessary while the engine is not running.

NOTICE

Do not fold the electric type outside rearview mirror by hand. It could cause motor failure.

Reverse parking aid (if equipped)

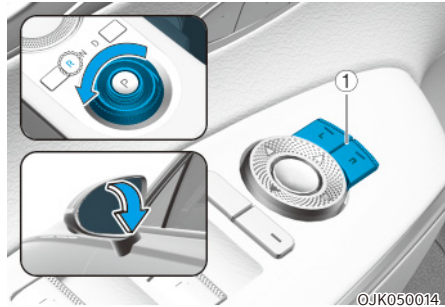

When the gear is shifted to the R (Reverse) position, the outside rearview mirror(s) will rotate downwards to aid with driving in reverse.

The state of the outside rearview mirror button (1) determines whether or not the mirrors will move:

How it works

- When the L or R button (1) is pressed (indicator lights ON), both outside rearview mirrors will move.
- If the L and R buttons (1) are not pressed (indicator lights OFF), both outside rearview mirrors will not move.

The outside rearview mirrors will automatically revert to their original positions if any of the following occur:

- The Engine Start/Stop button is pressed to either the OFF position or the ACC position.
- The gear is shifted to any position except R (Reverse).
- The outside rearview mirror adjustment button is not selected.

Reverse parking aid user settings mode

You may change the angle of the outside rearview mirror if it is difficult to see the rear view with the basic downward mirror angle provided when reversing.

When the vehicle is first delivered, the set downward angle of the left and right outside rearview mirror are different to ensure driver visibility.

1. Make sure the vehicle is stopped.
2. Depress the brake pedal and shift the gear to R (Reverse). When L (Left) or R (Right) button is pressed, both outside rearview mirror angle will move downward to the basic set position.
3. Press either L or R button to select the outside rearview mirror you would like to adjust. Then press “▼, ▲, ◀, ▶” switch to adjust the outside rearview mirror to the desired angle.
4. After adjusting the angle to save the adjusted outside rearview mirror angle, shift the gear to another position other than R (Reverse), or change the L and R buttons to the neutral position (L and R buttons are not pressed).
5. Set the opposite outside rearview mirror following the above procedure 1 to 4.

Resetting reverse parking aid user settings mode

To change the outside rearview mirror angle back to the basic angle, shift the gear to R (Reverse), and adjust the mirror angle higher than when the gear is in P (Park), N (Neutral) and D (Drive).

NOTICE

When changing the angle of both outside rearview mirrors, it is recommended to change the angle one side at a time following the procedure 1 to 4.

WINDOWS

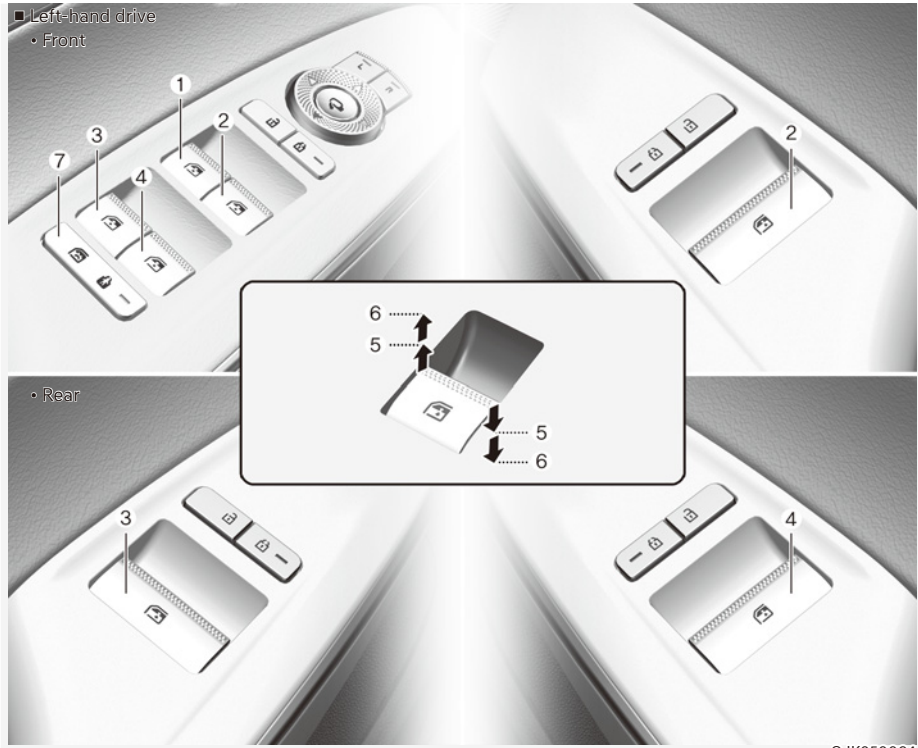

OJK050064

- (1) Driver's door power window switch
- (2) Front passenger's door power window switch
- (3) Rear door (left) power window switch
- (4) Rear door (right) power window switch
- (5) Window opening and closing
- (6) Automatic power window
- (7) Power window lock switch

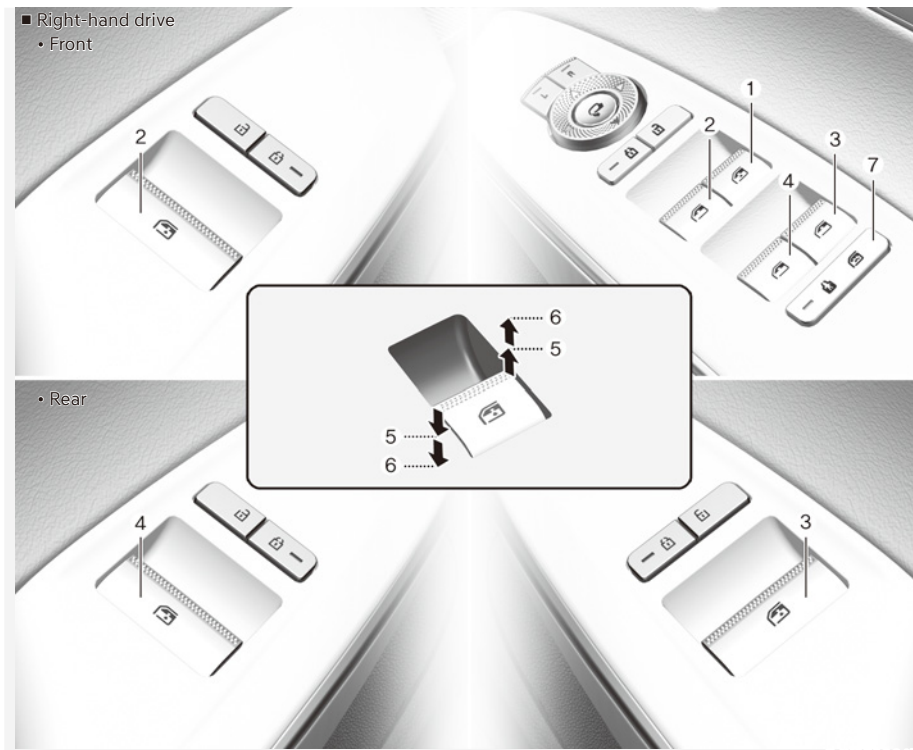

- | | |
|--|---|
| (1) Driver's door power window switch | (4) Rear door (right) power window switch |
| (2) Front passenger's door power window switch | (5) Window opening and closing |
| (3) Rear door (left) power window switch | (6) Automatic power window |
| | (7) Power window lock switch |

Power windows

The Engine Start/Stop button must be in the ON position to be able to raise or lower the windows. Each door has a Power Window switch to control that door's window. The driver has a Power Window Lock button which can block the operation of passenger windows. The power windows will operate for approximately 3 minutes after the Engine Start/Stop button is in the ACC or OFF position. However, if the front doors are opened, the Power Windows will not operate even within the 3 minute period.

Window opening and closing

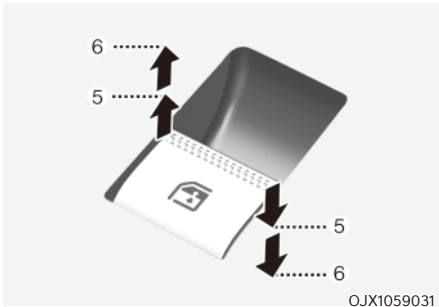

To open:

Press the window switch down to the first detent position (5). Release the switch when you want the window to stop.

To close:

Pull the window switch up to the first detent position (5). Release the window switch when you want the window to stop.

Auto up/down window

Pressing or pulling up the power window switch momentarily to the second detent position (6) completely lowers or lifts the window even when the switch is released. To stop the window at the desired position while the window is in operation, pull up or press down and release the switch.

WARNING

- Do not leave the engine running and the key in your vehicle with unsupervised children. Unattended children could operate the window, which could result in serious injury.
- Do not extend your head, arms or any other body parts or objects outside the window while driving to avoid serious injury.

Resetting the power windows

If the power windows do not operate normally, the automatic power window system must be reset as follows:

1. Press the Engine Start/Stop button to the ON position.
2. Close the window and continue pulling up on the power window switch for at least one second.

If the power windows do not operate properly after resetting, we recommend that the system be inspected by an authorized retailer of Genesis Branded products.

WARNING

The automatic reverse feature doesn't activate while resetting the power window system.

Make sure body parts or other objects are safely out of the way before closing the windows to avoid injuries or vehicle damage.

Automatic reverse



If a window senses any obstacle while it is closing automatically, it will stop and lower approximately 30 cm (12 in.) to allow the object to be cleared.

If the window detects the resistance while the power window switch is pulled up continuously, the window will stop upward movement then lower approximately 2.5 cm (1 in.).

If the power window switch is pulled up continuously again within 5 seconds after the window is lowered by the automatic window reverse feature, the automatic window reverse will not operate.

i Information

The automatic reverse feature is only active when the “Auto Up” feature is used by fully pulling up the switch to the second detent.

! WARNING

Make sure body parts or other objects are safely out of the way before closing the windows to avoid injuries or vehicle damage.

Objects less than 4 mm (0.16 in.) in diameter caught between the window glass and the upper window channel may not be detected by the automatic reverse window and the window will not stop and reverse direction.

Power window lock button



The driver can disable the power window switches on the rear passenger doors by pressing the power window lock button. When the power window lock button is pressed:

- The rear passenger control will not be able to operate the rear passenger power window.
- Note that the front passenger control is still able to operate the front passenger window, and that the driver master control can still operate all the power windows.

⚠ WARNING

Do not allow children to play with the power windows. Keep the driver's door power window lock button in the LOCK position. Serious injury or death can result from unintentional window operation by a child.

NOTICE

- To prevent possible damage to the power window system, do not open or close two windows or more at the same time. This will also ensure the longevity of the fuse.
- Never try to operate the main switch on the driver's door and the individual door window switch in opposite directions at the same time. If this is done, the window will stop and cannot be opened or closed.

Remote window opening/closing function (if equipped)

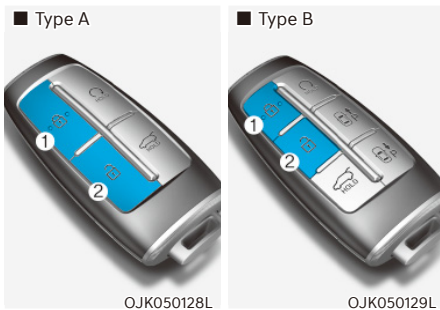

You can still control the window movement with the engine turned off by pressing the Door Lock button (1) or the Door Unlock button (2).

- Press the door lock button for more than 3 seconds. The doors will lock and the windows will move up as long as you press the door lock button.
- Press the door unlock button for more than 3 seconds. The doors will unlock and the windows will move down as long as you press the door unlock button.

i Information

- The remote window opening/closing function may abruptly stop when you move away from your vehicle during operation. Stay in close proximity from your vehicle, while monitoring the window movement.
- One of the windows may stop operating when the window is interrupted by certain force. However, the other windows will keep operating. Make sure that all windows are closed.
- Please be aware that the doors unlock when the windows are opened using the remote window open/closing function.

⚠ WARNING

Always double check to make sure arms, hands, head and other obstructions are safely out of the way before using remote window closing function.

PANORAMA SUNROOF (IF EQUIPPED)

If your vehicle is equipped with a sunroof, you can slide or tilt your sunroof with the sunroof control switch located on the overhead console.



The sunroof can only be opened, closed, or tilted when the Engine Start/Stop button is in the ON position.

The sunroof can be operated for approximately 3 minutes after the Engine Start/Stop button is in the ACC or OFF position. However, if the front door is opened, the sunroof cannot be operated even within the 3 minute period.



Information

- The sunroof will operate as follows:

Sunroof lever	Sunroof operation
Push rearward to 2nd detent	Shade + Sunroof open
Push rearward to 1st detent	Shade open
Push up	Tilt
Push forward to 2nd detent	Shade + Sunroof close
Push forward to 1st detent	Shade close

For more details on sunroof operation, refer to the following pages.

- In cold and wet climates, the sunroof may not work properly due to freezing conditions.
- After the vehicle is washed or in a rainstorm, be sure to wipe off any water that is on the sunroof before operating it.



WARNING

- Never adjust the sunroof or sunshade while driving. This could result in loss of control and an accident that may cause death, serious injury, or property damage.
- Make sure heads, hands, arms or any other body parts or objects are out of the way before operating the sunroof.
- Do not extend your head, arms, body parts or objects outside the sunroof while driving to avoid serious injury.
- Do not leave the engine running and the key in your vehicle with unsupervised children. Unattended children could operate the sunroof, which could result in serious injury.
- The sunroof is made of glass, subject to break in case of an accident. Passengers without the appropriate protection (for example, seat belt, CRS, etc.) may project out through the broken glass and may be seriously injured or even result in death.
- Do not sit on the top of the vehicle. It may cause injury or vehicle damage.

NOTICE

- Do not continue to move the sunroof control lever after the sunroof is fully opened, closed, or tilted. Damage to the motor or system components could occur.
- Make sure the sunroof is closed fully when leaving your vehicle.
If the sunroof is left open, rain or snow may wet the interior of the vehicle. Also, leaving the sunroof open when the vehicle is unattended may invite theft.
- Do not operate the sunroof when the roof bars are installed on the vehicle or when there is luggage on the roof.
- Close the sunroof when driving in dusty areas. Dust may cause the sunroof to malfunction.
- Periodically remove any dirt that may accumulate on the sunroof guide rail or between the sunroof and roof panel which may damage the sunroof.
- Do not try to open the sunroof when the temperature is below freezing or when the sunroof is covered with snow or ice, otherwise the motor could be damaged. In cold and wet climates, the sunroof may not work properly.

Sunshade

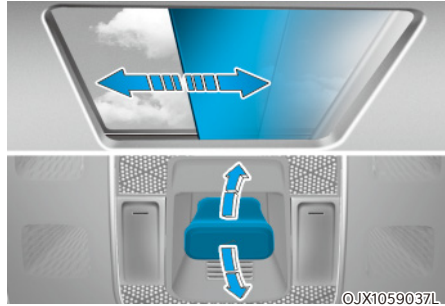

To open the sunshade:
Push the sunroof control lever rearward to the first detent position.

To close the sunshade when the sunroof glass is closed:
Push the sunroof control lever forward to the first detent position.

To stop the sunshade at any point, push the sunshade control lever momentarily.

NOTICE

Do not pull or push the sunshade by hand as such action may damage the sunshade or cause it to malfunction.

Sliding the sunroof



When the sunshade is closed:

Push the sunroof control lever rearward to the second detent position, both the sunshade and sunroof glass will slide all the way open.

When the sunshade is opened:

Push the sunshade control lever rearward to the first or second detent position, the sunroof glass will open.

To stop the sunroof movement at any point, push the sunroof control lever momentarily.



Information

Only the front glass of the sunroof opens and closes.

Tilting the sunroof

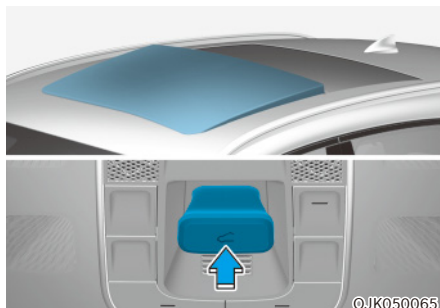

When the sunshade is closed:

Push the sunroof control lever upward, the sunshade will slide open then the sunroof glass will tilt.

When the sunshade is opened:

Push the sunroof control lever upward, the sunroof glass will tilt.

To stop the sunroof movement at any point, push the sunroof control lever momentarily.

Closing the sunroof

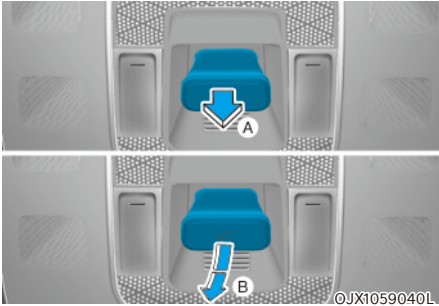

To close the sunroof glass only (A):
Push the sunroof control lever forward to the first detent position.

To close the sunroof glass with the sunshade (B):
Push the sunroof control lever forward to the second detent position. The sunroof glass and sunshade will close automatically.

To stop the sunroof movement at any point, push the sunroof control lever momentarily.

Automatic reverse

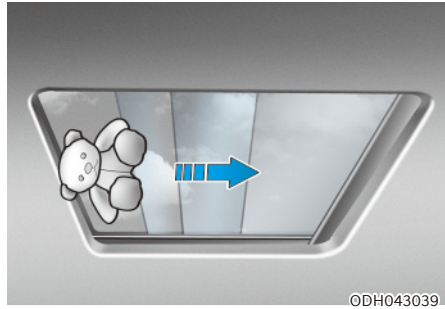

If the sunroof senses any obstacle while it is closing automatically, it will reverse direction then stop to allow the object to be cleared.

The auto reverse function does not work if a small obstacle is between the sliding glass and the sunroof sash.

You should always check that all passengers and objects are away from the sunroof before closing it.

WARNING

Small objects that can get caught between the sunroof glass and the front glass channel may not be detected by the automatic reverse system. In this case, the sunroof glass will not detect the object and reverse direction.

Resetting the sunroof

In some circumstances resetting the sunroof operation may need to be performed. Some instances where resetting the sunroof may be required include:

- When the 12V battery is either disconnected or discharged
- When the sunroof fuse is replaced
- If the sunroof one-touch AUTO OPEN/ CLOSE operation is not functioning properly

Sunroof resetting procedure:

1. It is recommended to perform the reset procedure with the vehicle engine running. Start the vehicle in P (Park).
2. Make sure the sunshade and sunroof is in the fully closed position. If the sunshade and sunroof is open, push the control lever forward until the sunshade and sunroof is fully closed.
3. Release the control lever when the sunshade and sunroof is fully closed.
4. Push the control lever forward about 10 seconds until the sunroof moves slightly.
5. Release the control lever.

6. Within 3 seconds, push and hold the control lever forward until the sunshade and sunroof operates as follows:

Sunshade Open → Glass Tilt Open → Glass Slide Open → Glass Slide Close → Sunshade Close

Do not release the lever until the operation is completed.

If you release the control lever during operation, start the procedure again from step 2.

7. Release the sunroof control lever after all steps have completed. The sunroof system has been reset.

Information

If the sunroof does not reset when the vehicle battery is disconnected or discharged, or the sunroof fuse is blown, the sunroof may not operate normally.

For more detailed information, we recommend that you contact an authorized retailer of Genesis Branded products.

Sunroof open warning

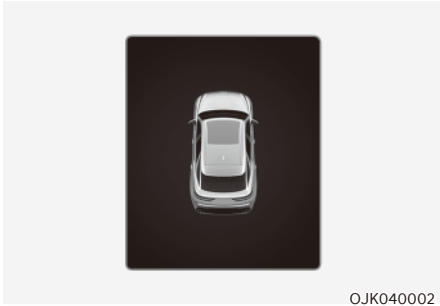

- If the driver turns off the engine when the sunroof is not fully closed, the warning chime will sound for approximately 3 seconds and the sunroof open warning will appear on the LCD display.
- If the driver turns off the engine and opens the door when the sunroof is not fully closed, the open sunroof warning will appear on the LCD display until the door is closed or the sunroof is fully closed.

Close the sunroof securely when leaving your vehicle.

EXTERIOR FEATURES

Hood

Opening the hood

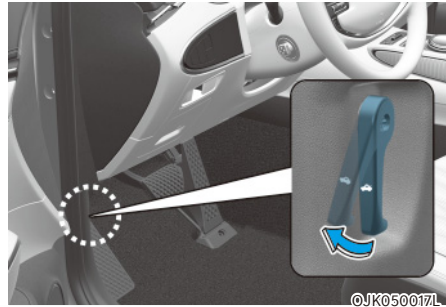

1. Park the vehicle and set the parking brake.
2. Pull the release lever to unlatch the hood. The hood should pop open slightly.

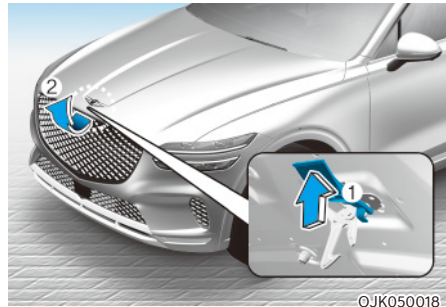

3. Go to the front of the vehicle, raise the hood slightly, push up the secondary latch (1) inside of the hood center and lift the hood (2).

After the hood has been lifted halfway, it will raise completely by itself.

Closing the hood

1. Before closing the hood, check in and around the engine compartment to ensure the following:
 - Any tools or other loose objects are removed from the engine room area or hood opening area
 - All glove, rags, or other combustible material is removed from the engine compartment
 - All filler caps are tightly and correctly installed
2. Lower the hood halfway (lifted approximately 30 cm (12 in.) from the closed position) and push down to securely lock in place. Then double check to be sure the hood is secure. If the hood can be raised slightly, it is not securely locked. Open it again and close it with more force.



WARNING

- Before closing the hood, ensure all obstructions are removed from around the hood opening.
- Always double check to be sure that the hood is firmly latched before driving away. Check there is no hood open warning light or message displayed on the instrument cluster. Driving with the hood opened may cause a total loss of visibility, which might result in an accident.
- Do not move the vehicle with the hood in the raised position, as vision is obstructed, which might result in an accident, and the hood could fall or be damaged.

Power tailgate

The power tailgate open/close button automatically opens and closes the tailgate.

Before using the power tailgate

The power tailgate operates when the gear is in P (Park) with the Engine Start/ Stop button in the ON position. However, the tailgate will operate regardless of the gear position when the engine is off.

For safety, before attempting to open or close the tailgate, make sure the vehicle is in P (Park).



WARNING

- Never leave children unattended in your vehicle. Children might operate the power tailgate. Doing so could result in injury to themselves or others, and could damage the vehicle.
- Make sure there are no people or objects around the tailgate before operating the power tailgate. Wait until the tailgate is opened fully and stopped before loading or unloading cargo or passengers from the vehicle.

NOTICE

Do not close or open the power tailgate manually. This may cause damage to the power tailgate. If it is necessary to close or open the power tailgate manually when the battery is discharged or disconnected, do not apply excessive force.

Setting the power tailgate

The driver can select the power tailgate opening height or speed from the Settings menu in the infotainment system screen.

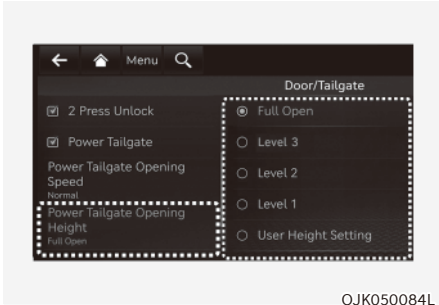

Power tailgate opening height

To adjust the power tailgate opening height, select 'Setup → Vehicle Settings → Door/Tailgate → Power Tailgate Opening Height → Full Open/Level 3/ Level 2/Level 1/User Height Setting'.

For detailed information, scan the QR code in the separately supplied simple manual.

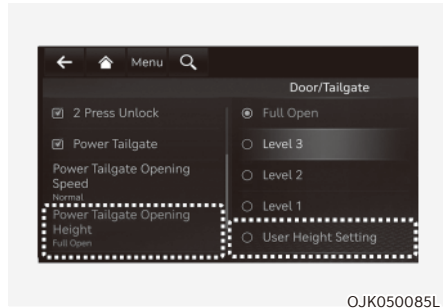

You can manually adjust the height of the power tailgate that you prefer regardless of the height options (Full Open/Level3/Level2/Level1) in the infotainment system.

1. Position the tailgate manually to the height you prefer.
2. Press the power tailgate open/close button located inside the tailgate for more than 3 seconds.
3. Close the tailgate after hearing the buzzer sound.
4. The tailgate will open to the manually adjusted height that was set.

i Information

- If the power tailgate opening height is set manually, and then 'User Height Setting' is selected from the infotainment system, the power tailgate will automatically open to the height manually set by the driver.
- If the power tailgate opening height has not been manually set, the power tailgate will fully open when 'User Height Setting' from the infotainment system is selected.
- If one of the height (Full Open/Level3/Level2/Level1) is selected from the settings menu in the infotainment system screen, and then 'User Height Setting' is selected, the power tailgate open height will be set to the previously saved height.

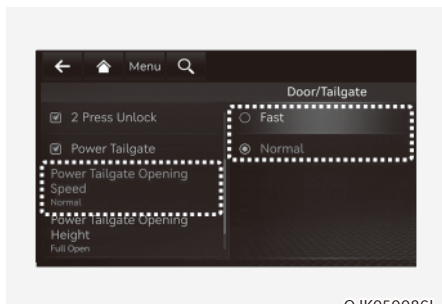

Power tailgate opening speed

To adjust the power tailgate opening speed, select 'Setup → Vehicle Settings → Door/Tailgate → Power Tailgate Opening Speed → Fast/Normal'.

For detailed information, scan the QR code in the separately supplied simple manual.

Opening and closing the power tailgate

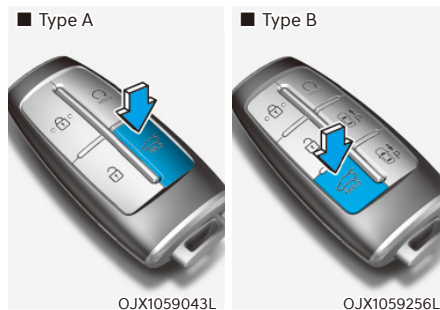

Smart key

Press and hold the tailgate open/close button on the smart key. The power tailgate will open or close with a warning sound.

While the tailgate is opening or closing, press the button to stop tailgate operation. Press the button again to restart operation.

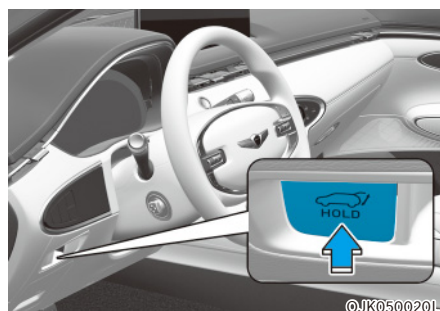

Power tailgate open/close button

Press and hold the tailgate open/close button. The power tailgate will open or close with a warning sound.

While the tailgate is opening or closing, press the button to stop tailgate operation. Press the button again to restart operation.

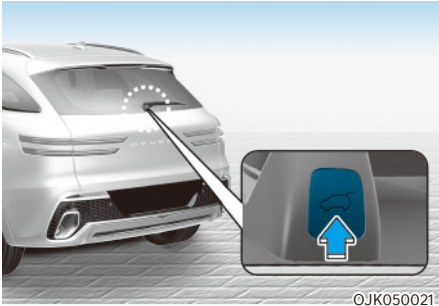

Power tailgate open/close button

If the tailgate is closed, the tailgate will open with a warning sound when you press the tailgate open/close button while carrying the smart key.

If the doors are unlocked, the tailgate will open with a warning sound when you press the tailgate open/close button even without carrying the smart key.

When the tailgate is opened, pressing the tailgate open/close button will open or close the tailgate even without carrying the smart key.

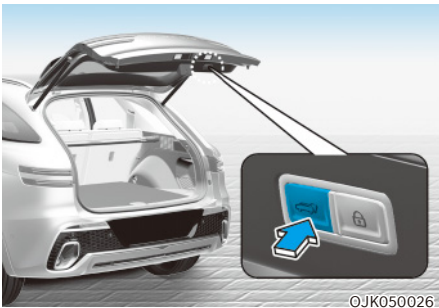

Power tailgate open/close button

Press the tailgate open/close button located inside the tailgate to open or close the power tailgate. The power tailgate will open or close with a warning sound.

While the tailgate is opening or closing, press the button to stop tailgate operation. Press the button again to restart operation.



Power tailgate lock button

Press the tailgate lock button located inside the tailgate while carrying the smart key to close and lock the power tailgate. The tailgate will open and close with the warning sound.

While the tailgate is closing, press the button to stop tailgate operation. Press the button again to restart operation.

WARNING

Always keep the tailgate completely closed while the vehicle is in motion. If it is left open or ajar, poisonous exhaust gases containing carbon monoxide (CO) may enter the vehicle and serious illness or death may result.

NOTICE

- The power tailgate can be operated when the engine is not running. However, power tailgate operation consumes a large amount of electric power. To prevent the battery from being discharged, do not operate it excessively (for example, more than 5 times repeatedly).
- To prevent the battery from being discharged, do not leave the power tailgate in the open position for a long time.
- Do not modify or repair any part of the power tailgate by yourself. We recommend that you have the power tailgate modified or repaired by an authorized retailer of Genesis Branded products.
- When jacking up the vehicle to change a tire or repair the vehicle, do not operate the power tailgate. This could cause the power tailgate to operate improperly.
- In cold and wet climates, the power tailgate may not work properly due to freezing conditions.

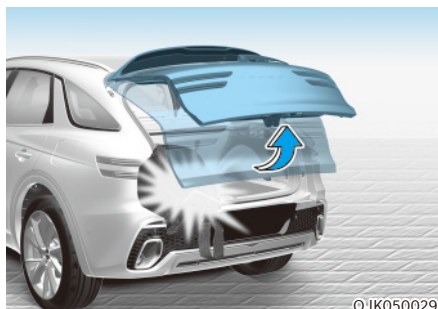
Automatic reverse

During power opening or closing if the power tailgate senses any obstacle, the power tailgate will stop and move in the opposite direction.

The auto reverse function may not work if objects are too soft or thin, or if the tailgate is almost fully closed near the latched position.

Caution should be taken to prevent any objects from obstructing the tailgate opening.

If the automatic reverse feature operates more than two times while attempting to open or close the tailgate, the power tailgate may stop at that position. If this occurs, carefully close the tailgate manually, and then try to operate the power tailgate automatically again.

**WARNING**

Never intentionally place any object or part of your body in the path of the power tailgate to make sure the automatic reverse function operates.

NOTICE

Do not put heavy objects on the power tailgate before you operate the power tailgate. Additional weight may damage the operation of the system.

Non-operating conditions of the power tailgate

- The power tailgate does not open when the vehicle is in motion.
The chime will sound if you drive with the tailgate opened. Stop your vehicle immediately at a safe place and check if your tailgate is opened.
- Operating the power tailgate more than 5 times continuously could cause damage to the operating motor. If this occurs, the power tailgate system enters into thermal protection mode to prevent the motor from overheating. In thermal protection mode, the power tailgate will not operate. If any of the power tailgate buttons are pressed to try to open the tailgate, the chime will sound 3 times but the tailgate will remain closed.
Allow the power tailgate system to cool for about 1 minute before operating the system again.

Resetting the power tailgate

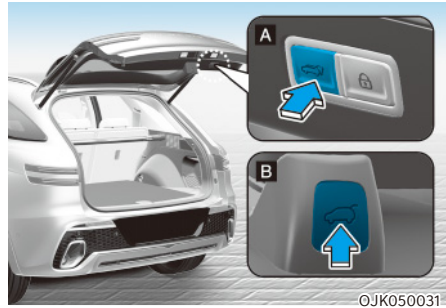

If the battery has been discharged or disconnected, or if the power tailgate fuse has been replaced or removed, reset the power tailgate by performing the following procedure:

1. With the engine off or on, put the gear in P (Park).
2. Press the power tailgate inner button (A) and the power tailgate outer button (B) simultaneously for more than 3 seconds. The chime will sound.
3. Close the tailgate manually.
4. Open the tailgate by pressing the power tailgate outer button (B).
5. The tailgate will open with a chime sound.

If the power tailgate does not work properly after the above procedure, we recommend that you have the system inspected by an authorized retailer of Genesis Branded products.

Information

If the tailgate is stopped before the tailgate is fully open, resetting will not proceed. Wait until the tailgate is fully open.

 **WARNING**



OJK050088L

Do not hold on to or try to pull on the tailgate strut. Be aware that the deformation of the tailgate strut may cause vehicle damage and risk of injury.

Emergency tailgate safety release

Your vehicle is equipped with an emergency tailgate safety release lever located on the bottom of the tailgate inside the vehicle.

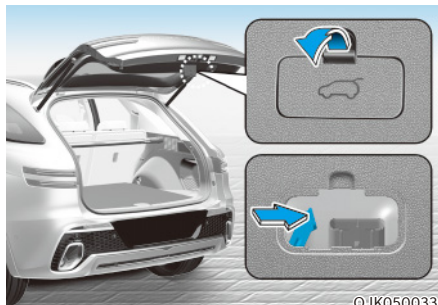

OJK050033

To unlock and open the tailgate manually from inside the luggage compartment, perform the following procedure:

1. Remove the cover.
2. Push the release lever to the right.
3. Push the tailgate outward and upward.

 **WARNING**

- **Be aware of the location of the emergency tailgate safety release lever in your vehicle and know how to open the tailgate using the safety release lever.**
- **No one, including animals, should be allowed to occupy the luggage compartment of the vehicle at any time. The luggage compartment is a very dangerous location in the event of an accident.**
- **Use the release lever for emergencies only. Use extreme caution, especially while the vehicle is in motion.**

Smart tailgate

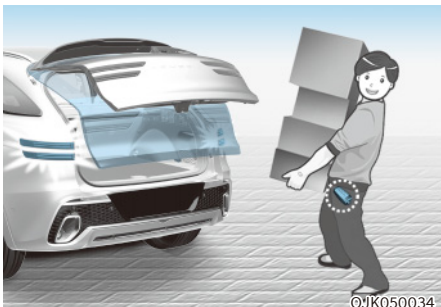

On a vehicle equipped with a smart key, the tailgate can be opened with hands-free activation using the smart tailgate system.

Using smart tailgate

The hands-free smart tailgate system can be opened automatically when the following conditions are met:

- The smart tailgate option is enabled in the Settings menu in the infotainment system screen.
- The smart tailgate is activated and ready 15 seconds after all the doors are closed and locked.
- The smart tailgate will open when the smart key is detected in the area behind the vehicle for 3 seconds.

i Information

The smart tailgate will **NOT** operate when:

- A door is not locked or closed.
- The smart key is detected within 15 seconds from when the doors were closed and locked.
- The smart key is detected within 15 seconds after the doors are closed and locked, and within 1.5 m (60 in.) from the front door handles. (for vehicles equipped with Welcome Light).
- The smart key is in the vehicle.

1. Settings

To use smart tailgate, it must be enabled from the Settings menu in the infotainment system screen. Select:

- Setup → Vehicle Settings → Door/Tailgate → Smart Tailgate

For detailed information, scan the QR code in a separately supplied simple manual.

2. Detect and Alert

The smart tailgate detecting area extends approximately 50-100 cm (20-40 in.) behind the vehicle. If you are positioned in the detecting area and are carrying the smart key, the hazard warning lights will blink and the chime will sound to alert you that the smart tailgate will open.

i Information

Do not approach the detecting area if you do not want the tailgate to open. If you have unintentionally entered the detecting area and the hazard warning lights and chime starts to operate, move away from the area behind the vehicle with the smart key. The tailgate will remain closed.

3. Automatic opening

After the hazard warning lights blink and the chime sounds 6 times, the smart tailgate will open.

Deactivating smart tailgate

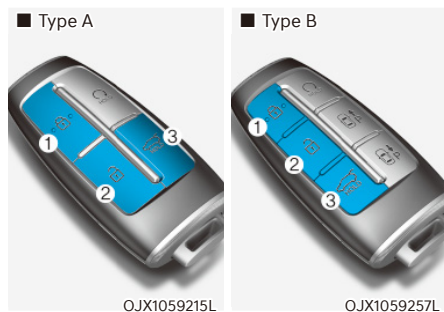

1. Door lock
2. Door unlock
3. Tailgate open/close

If you press any button on the smart key during the Detect and Alert stage, the smart tailgate will be deactivated.

Make sure to be aware of how to deactivate the smart tailgate for emergency situations.

- If you press the door unlock button (2), the smart tailgate will be deactivated temporarily. But, if you do not open any door for 30 seconds, the smart tailgate will be activated again.
- If you press the tailgate open button (3) for more than 1 second, the tailgate opens.
- The smart tailgate will still be activated if you press the door lock button (1) or tailgate open/close button (3) on the smart key as long as the smart tailgate is not already in the Detect and Alert stage.
- In case you have deactivated the smart tailgate by pressing the smart key button and opened a door, the smart tailgate can be activated again by closing and locking all doors.

Detecting area



- The smart tailgate detecting area extends approximately 50-100 cm (20-40 in.) behind the vehicle. If you are positioned in the detecting area and are carrying the smart key, the hazard warning lights will blink and the chime will sound for about 3 seconds to alert you that the tailgate will open.

- The alert stops once the smart key is moved outside of the detecting area within the 3 second period.

i Information

- Smart tailgate may not operate properly if any of the following occur:
 - The smart key is close to a radio transmitter such as a radio station or an airport which can interfere with normal operation of the transmitter.
 - The smart key is near a mobile two way radio system or a mobile phone.
 - Another vehicle's smart key is being operated close to your vehicle.
- Smart tailgate detecting area may change when:
 - The vehicle is parked on an incline or slope.
 - One side of the vehicle is raised or lowered relative to the opposite side.

Fuel filler door
Opening the fuel filler door

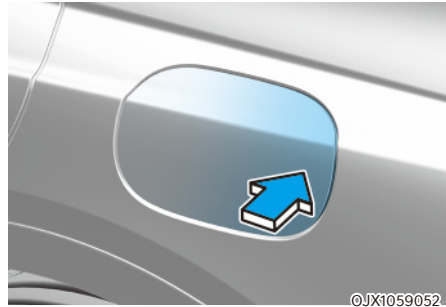

1. Turn the engine off.
2. Ensure the driver's door is unlocked.
3. Push the fuel filler door near the 3 o'clock position.

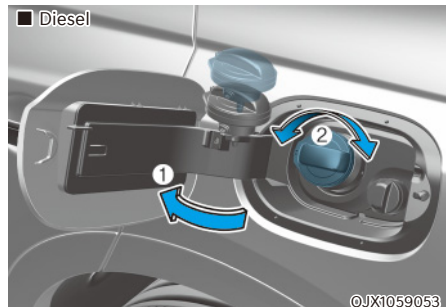
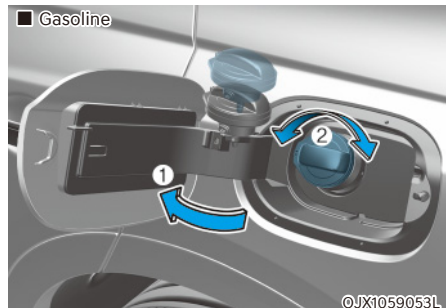

4. Pull the fuel filler door (1) outward to access the fuel tank cap.

5. To remove the fuel tank cap (2), turn it counterclockwise. You may hear a hissing noise as the pressure inside the tank equalizes.
6. Place the cap on the fuel filler door.

Information

Refer to Chapter 9, “Selective Catalytic Reduction (SCR)” section for information on urea solution for diesel engine vehicles.

Information

If the fuel filler door does not open because ice has formed around it, tap lightly or push on the door to break the ice and release the door. Do not pry on the door. If necessary, spray around the door with an approved deicer fluid (do not use radiator antifreeze) or move the vehicle to a warm place and allow the ice to melt.

Closing the fuel filler door

1. To install the fuel tank cap, turn it clockwise until it “clicks” one time.
2. Close the fuel filler door until it is latched securely.

Information

The fuel filler door will not close if the driver’s door is locked. If you lock the driver’s door while fueling, unlock it before closing the fuel filler door.



WARNING

Automotive fuel is highly flammable and explosive. Failure to follow these guidelines may result in **SERIOUS INJURY** or **DEATH**:

- Read and follow all warnings posted at the gas station.
- Before refueling, note the location of the Emergency Fuel Shut-Off, if available, at the gas station.
- Before touching the fuel nozzle, you should eliminate the potential buildup of static electricity by touching a metal part of the vehicle, a safe distance away from the fuel filler neck, nozzle, or other gas source, with your bare hand.
- Do not use mobile phones while refueling. Electric current and/or electronic interference from cellular phones can potentially ignite fuel vapors and cause a fire.
- Do not get back into a vehicle once you have begun refueling. You can generate a buildup of static electricity by touching, rubbing or sliding against any item or fabric capable of producing static electricity. Static electricity discharge can ignite fuel vapors causing a fire. If you must re-enter the vehicle, you should once again eliminate potentially dangerous static electricity discharge by touching a metal part of the vehicle, away from the fuel filler neck, nozzle or other fuel source, with your bare hand.

- When using an approved portable fuel container, be sure to place the container on the ground prior to refueling. Static electricity discharge from the container can ignite fuel vapors causing a fire.
Once refueling has begun, contact between your bare hand and the vehicle should be maintained until the filling is complete.
- Use only approved portable plastic fuel containers designed to carry and store fuel.
- When refueling, always shift the gear to the P (Park) position, set the parking brake, and press the Engine Start/Stop button to the OFF position. Sparks produced by electrical components related to the engine can ignite fuel vapors causing a fire.
- Do not use matches or a lighter and do not smoke or leave a lit cigarette in your vehicle while at a gas station, especially during refueling.
- Do not over-fill or top-off your vehicle tank, which can cause fuel spillage.
- If a fire breaks out during refueling, leave the vicinity of the vehicle, and immediately contact the manager of the gas station and then contact the local fire department. Follow any safety instructions they provide.
- If pressurized fuel sprays out, it can cover your clothes or skin and thus subject you to the risk of fire and burns. Always remove the fuel cap carefully and slowly. If the cap is venting fuel or if you hear a hissing sound, wait until the condition stops before completely removing the cap.
- Always check that the fuel cap is installed securely to prevent fuel spillage in the event of an accident.

Information

Make sure to refuel your vehicle according to the “Fuel Requirements” section in suggested in chapter 1.

NOTICE

- Do not spill fuel on the exterior surfaces of the vehicle. Any type of fuel spilled on painted surfaces may damage the paint.
- If the fuel filler cap requires replacement, we recommend that you only use a genuine Genesis cap or the equivalent (of the genuine part) specified for your vehicle. An incorrect fuel filler cap can result in a serious malfunction of the fuel system or emission control system.

HEAD-UP DISPLAY (HUD) (IF EQUIPPED)



The Head-Up Display is an optional feature that allows the driver to view information projected onto a transparent screen while still keeping your eyes safely on the road ahead while driving.

Head-up display settings

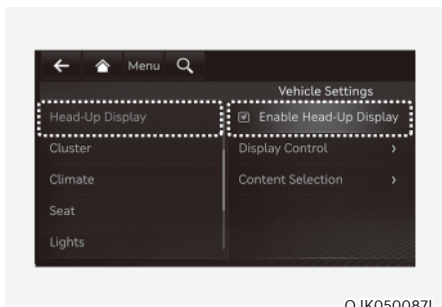

- Head-up display can be enabled from the Settings menu in the infotainment system screen. Select:
 - Setup → Vehicle Settings → Head-Up Display → Enable Head-Up Display
- After turning on the head-up display, you can change the settings of 'Display Control' and 'Content Selection' of the Head-Up Display.

For detailed information, scan the QR code in a separately supplied simple manual.

Head-up display information

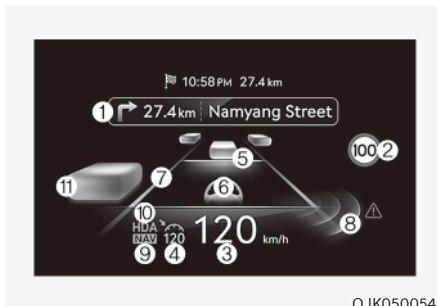

1. Turn by Turn (TBT) navigation information
2. Traffic information
3. Speedometer information
4. SCC set speed information
5. SCC vehicle distance information
6. Lane Following Assist information
7. Lane Safety information
8. Blind-Spot Safety information
9. Highway Auto Speed Change information
10. Highway Driving Assist information
11. Surrounding vehicle information

Precautions while using the head-up display

- It may sometimes be difficult to read information on the Head-Up Display in the following situations.
 - The driver is improperly positioned in the driver's seat
 - The driver wears polarizing-filter sunglasses
 - An object is located above the head-up display cover
 - The vehicle is driven on a wet road
 - Any improper lighting accessory is installed inside the vehicle, or there is incoming light from outside of the vehicle
 - The driver wears glasses
 - The driver wears contact lenses

When it is difficult to read the Head-Up Display information, adjust the image height or brightness level from the Settings menu in the infotainment system screen.

- For your safety, make sure to stop the vehicle before adjusting the settings.
- Do not tint the front windshield glass or add other types of metallic coating. Otherwise, the Head-Up Display image may be invisible.
- Do not place any accessories on the crash pad or attach any objects on the windshield glass.
- When replacing the front windshield glass, replace it with a windshield glass designed for Head-Up Display operation. Otherwise, duplicated images may be displayed on the windshield glass.



WARNING

The warning information of Blind-Spot Safety on the Head-Up Display are supplemental. Do not solely depend on them to change lanes. Always take a look around before changing lanes.



Information

Head-up Display includes GPL, LGPL, MPL and other open source license softwares. All license notices including related source code are provided at <http://www.mobis.co.kr/opensource/list.do>.

If the driver requests on-board software open source code via MOBIS_OSSrequest@mobis.co.kr within 3 years after buying this product, a CD-ROM or other storage device will be sent with the minimum cost covering storage device cost and delivery cost.

LIGHTING

Exterior lights

Lighting control

To operate the lights, turn the knob at the end of the control lever to one of the following positions:

■ Type A



OJX1059057

■ Type B



OJX1059057L

■ Type C



OJX1059057R

1. OFF position
2. AUTO headlamp position
3. Position lamp position
4. Headlamp position

Daytime Running Light (DRL)

The Daytime Running Lights (DRL) can make it easier for others to see the front of your vehicle during the day, especially after dawn and before sunset.

The DRL system will turn the dedicated lamp OFF when :

- The headlamps are ON.
- The parking brake is applied.
- The vehicle is turned off.

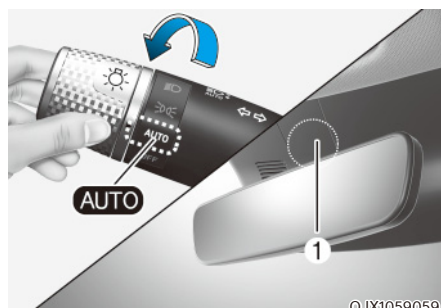

OJX1059059

AUTO headlamp position

The position lamp and headlamp will be turned ON or OFF automatically depending on the amount of daylight as measured by the ambient light sensor (1) at the upper end of the windshield glass.

Even with the AUTO headlamp feature in operation, it is recommended to manually turn ON the headlamps when driving at night or in a fog, driving in the rain, or when you enter dark areas, such as tunnels and parking facilities.

NOTICE

- Do not cover or spill anything on the sensor (1) located at the upper end of the windshield glass.
- Do not clean the sensor using a window cleaner, the cleanser may leave a light film which could interfere with sensor operation.
- If your vehicle has window tint or other types of metallic coating on the front windshield, the AUTO headlamp system may not work properly.

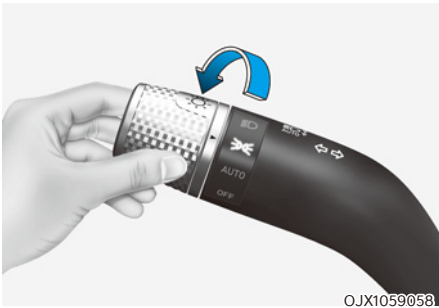

Position lamp position (☞☜)

The position lamp, license plate lamp and instrument panel lamp are turned ON.

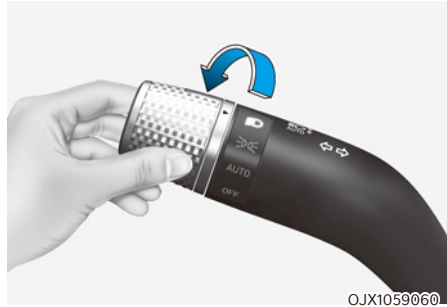

Headlamp position (☞☜)

The headlamp, position lamp, license plate lamp and instrument panel lamp are turned ON.

i Information

The Engine Start/Stop button must be in the ON position to turn on the headlamp.

High beam operation

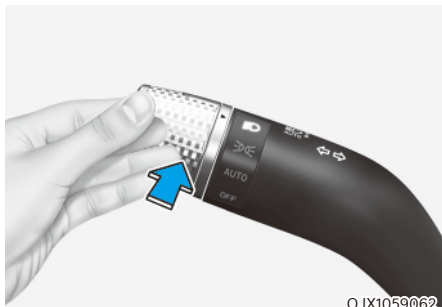

To turn on the high beam headlamp, push the lever away from you. The lever will return to its original position.

The high beam indicator will light when the headlamp high beams are switched on.

To turn off the high beam headlamp, pull the lever towards you. The low beams will turn on.

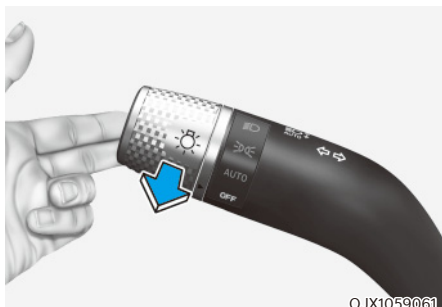

To flash the high beam headlamp, pull the lever towards you, then release the lever. The high beams will remain ON as long as you hold the lever towards you.

Turn signals and lane change signals

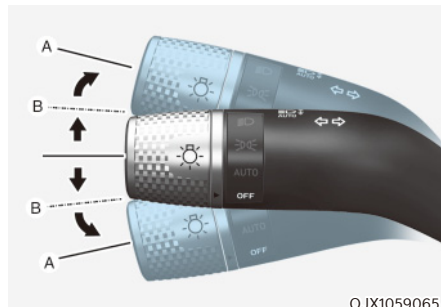

To signal a turn, push down on the lever for a left turn or up for a right turn in position (A).

If an indicator stays on and does not flash or if it flashes abnormally, one of the turn signal bulbs may be burned out and will require replacement.

One touch turn signal

To use One Touch Turn Signal push the turn signal lever up or down to position (B) and then release it.

The lane change signals will blink 3, 5 or 7 times.

You can enable the One Touch Turn Signal function or choose the number of blinking by selecting 'Setup → Vehicle Settings → Lights → One Touch Turn Signal (or One-touch indicator) → 3 flashes/5 flashes/7 flashes/Off' in the infotainment system screen.

For detailed information, scan the QR code in a separately supplied simple manual.

Rear fog lamp (if equipped)

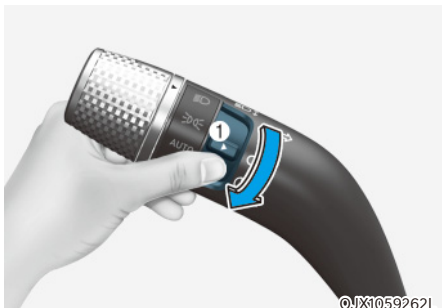

To turn on the rear fog lamp:
Position the headlamp switch in the headlamp position, and then turn the headlamp switch (1) to the rear fog lamp position.

To turn the rear fog lamps off, do one of the following:

- Turn off the headlamp switch.
- Turn the headlamp switch (1) to the rear fog lamp position again.

Battery saver function

The purpose of this feature is to prevent the battery from being discharged. The system automatically turns off the position lamp when the driver turns the vehicle off and opens the driver-side door.

With this feature, the position lamps will turn off automatically if the driver parks on the side of road at night.

However, the position lamps stay ON even when the driver-side door is opened if the headlamp switch is turned to the position lamp or AUTO (if equipped) position after the engine is turned off.

If necessary, to keep the lamps on turn the position lamps OFF and ON again using the headlamp switch on the steering column after the engine is turned off.

Headlamp delay function

If the Engine Start/Stop button is in the ACC position or the OFF position with the headlamps ON, the headlamps (and/or position lamps) remain on for about 5 minutes. However, if the driver's door is opened and closed, the headlamps are turned off after 15 seconds. Also, with the vehicle off if the driver's door is opened and closed, the headlamps (and/or position lamps) are turned off after 15 seconds.

The headlamps (and/or position lamps) can be turned off by pressing the lock button on the smart key twice or turning the headlamp switch to the OFF or AUTO position.

You can enable the headlamp delay function by selecting 'Setup → Vehicle Settings → Lights → Headlight Delay (or Headlight time-out)' in the infotainment system screen.

For detailed information, scan the QR code in a separately supplied simple manual.

NOTICE

If the driver exits the vehicle through another door besides the driver door, the battery saver function does not operate and the headlamp delay function does not turn OFF automatically.

This may cause the battery to discharge. To avoid battery discharge, turn OFF the headlamps manually from the headlamp switch before exiting the vehicle.

Headlight leveling device

Headlight leveling device automatically adjusts the headlamp beam level according to the number of passengers and loading weight in the luggage area.

It also adjusts to the appropriate headlamp beam level for various situations.



WARNING

If the function does not work properly, we recommend that the system be inspected by an authorized retailer of Genesis Branded products. Do not attempt to inspect or replace the wiring yourself.

Headlamp moisture removal function

When moisture fogs up inside of the headlamp with the headlamp on for a certain period of time, the fan circulates air inside the headlamp to remove moisture. If moisture is not removed, we recommend that the vehicle be inspected by an authorized retailer of Genesis Branded products.

Reverse guide lamp

When the gear is in R (Reverse), the reverse lamp turns on and the reverse guide lamp at the back of the vehicle lights the floor.

The lamp informs nearby drivers that your vehicle is backing up.

Interior lights



WARNING

Do not use the interior lights when driving in the dark. The interior lights may obscure your view and cause an accident.

NOTICE

Do not use the interior lights for extended periods when the vehicle is turned off or the battery will discharge.

Interior lamp AUTO cut

The interior lamps will automatically go off approximately 20 minutes after the vehicle is turned off and the doors are closed. If a door is opened, the lamp will go off 25 minutes after the vehicle is turned off. If the doors are locked by the smart key and the vehicle enters the armed stage of the theft alarm system, the lamps will go off five seconds later.

Front lamps



Front map lamp (☾ ☽):

Touch either icons to turn the map lamp on or off. This light produces a spot beam for convenient use as a map lamp at night or as a personal lamp for the driver and the front passenger.

Door lamp (🚪):

The front or rear room lamps come on when the front or rear doors are opened. When doors are unlocked by the smart key, the front and rear lamps come on for approximately 30 seconds as long as any door is not opened. The front and rear room lamps go out gradually after approximately 30 seconds when the door is closed. However, if the Engine Start/Stop button is in the ON position or all doors are locked, the front and rear lamps will turn off. If a door is opened with the Engine Start/Stop button in the ACC position or the OFF position, the front and rear lamps will stay on for about 5 minutes.

Room lamp (☽☽)

Press the button to turn ON the room lamp for the front/rear seats.

Rear lamps

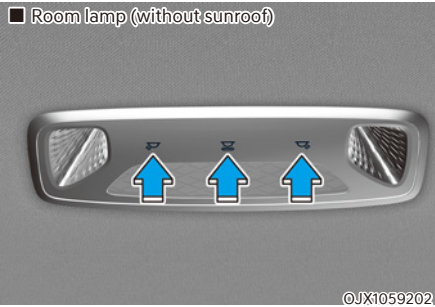

☾ ☽ :

Touch the icon to turn either lamp on or off.

☽ :

Touch the icon to turn the mood lamp on or off.



☽ :

Press the button to turn the lamp on or off.

Vanity mirror lamp

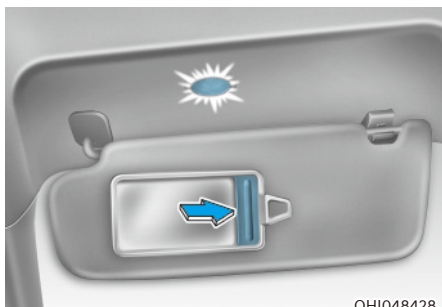

Opening the lid of the vanity mirror will automatically turn on the mirror lamp.

Glove box lamp

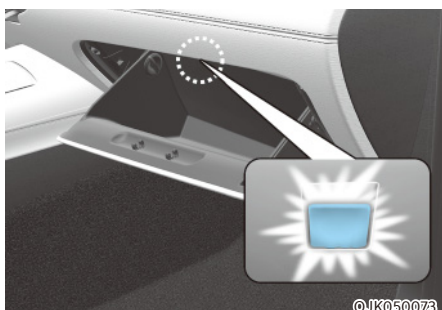

The glove box lamp turns on when the glove box is opened.

Door handle lamp/Mood lamp/Door courtesy lamp (if equipped)

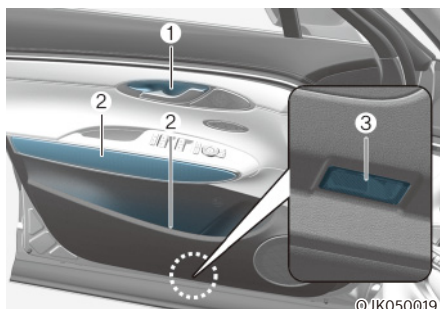

- Door handle lamp (1):
The lamp turns on when the position lamps are on.
- Mood lamp (2):
The lamp turns on when 'Setup → Vehicle Settings → Lights → Ambient Light' is selected from the infotainment system screen.
- Door courtesy lamp (3):
The lamp turns on when a door is open and turns off when the door is closed.

Luggage compartment lamp



The lamp turns on when the tailgate is opened.

Puddle lamp



Welcome light

When all doors (and tailgate) are closed and locked, the puddle lamp will turn on for 15 seconds if the door is unlocked by the smart key or when you put your hand in the outside door handle with the smart key in possession.

For more details, refer to “Welcome System” in this chapter.

Escort light

When the Engine Start/Stop button is in the OFF position and the driver’s door is opened, the puddle lamp will turn on for 30 seconds. If the driver’s door is closed within the 30 second period, the puddle lamp will turn off after 15 seconds. If the driver’s door is closed and locked, the puddle lamp will turn off immediately.

The Puddle Lamp Escort Light will turn on only the first time the driver’s door is opened after the engine is turned off.

Welcome system



Welcome system helps keep the driver visible by turning on vehicle lights when the driver approaches the vehicle.

Puddle lamp and door handle lamp

When all the doors (and tailgate) are closed and locked, the puddle lamp and door handle lamp will turn on for approximately 15 seconds if any of the below is performed.

- When the door unlock button is pressed on the smart key.
- When you put your hand in the outside door handle with the smart key in possession.
- If 'Setup → Vehicle Settings → Convenience → Welcome Mirror/Light → Enable on Driver Approach' is selected from the Settings menu in the infotainment system screen, the lamps will turn on when the vehicle is approached with the smart key in possession.

For detailed information, scan the QR code in a separately supplied simple manual.

Headlamp and position lamp

When the light switch is ON, and all the doors (and tailgate) are closed and locked, the headlamp and position lamp will turn on for approximately 15 seconds if the door unlock button is pressed on the smart key. Note that if the light switch is in the AUTO position, the headlamp and position light will turn on only when it is dark outside.

Select 'Setup → Lights → Headlight Delay' from the Settings menu to turn on this function.

Interior lamp

When the interior lamp switch is in the (☞) position and all doors (and tailgate) are closed and locked, the room lamp will come on for 30 seconds if any of the below is performed.

- When the door unlock button is pressed on the smart key.
- When you put your hand in the outside door handle while carrying the smart key.

At this time, if you press the door lock or unlock button on the smart key the lamps will turn off immediately.

INTELLIGENT FRONT-LIGHTING SYSTEM (IFS) (IF EQUIPPED)

Intelligent Front-Lighting System secures a clear view for the driver with the high beam on while driving at night.

Intelligent Front-Lighting System settings

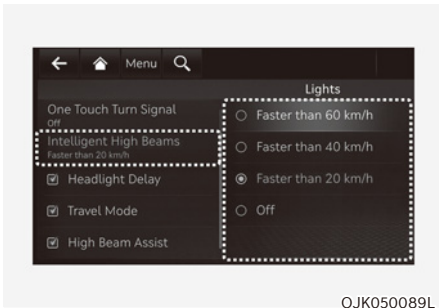

With the Engine Start/Stop button in the ON position, select 'Lights → Intelligent High Beams (or Smart High Beam)' from the Settings menu to turn on Intelligent Front-Lighting System and deselect to turn off the system.

WARNING

For your safety, change the Settings after parking the vehicle at a safe location.

Intelligent Front-Lighting System operation

Operating conditions

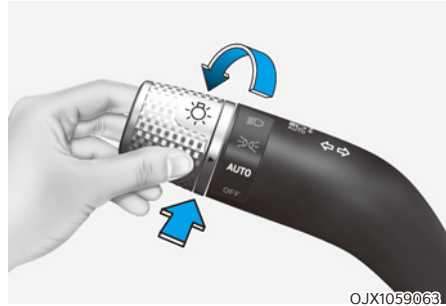

1. Place the headlamp switch in the AUTO position.
2. Push the headlamp lever toward the instrument cluster. The Intelligent Front-Lighting System () indicator light will illuminate on the cluster and the system will be enabled.
3. Intelligent Front-Lighting System will operate according to the set speed in the infotainment system. The initial system is set to work when vehicle speed is above 40 km/h (25 mph).

Operating Intelligent Front-Lighting System

- The high beam LED partially turns off if an oncoming vehicle or a vehicle ahead is detected by the front view camera.
- If Intelligent Front-Lighting System detects an oncoming vehicle or a vehicle ahead while driving at high speed (approximately above 100 km/h (60 mph), the driver's side headlamp will turn off and only the passenger's side headlamp will be controlled by the system.





Information

Intelligent Front-Lighting System operates when vehicle speed is above the set speed from the settings menu and when the outside ambient light condition is dark. Therefore, Intelligent Front-Lighting System may not work in areas with bright streetlights.

Intelligent Front-Lighting System malfunction and limitations

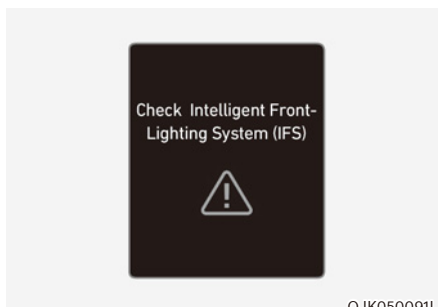
Intelligent Front-Lighting System malfunction



When Intelligent Front-Lighting System is not working properly, the 'Check Intelligent Front-Lighting System (IFS)' warning message will come on for a few second on the cluster. After the message disappears, AFS and  warning lights will illuminate on the cluster. We recommend that the system be inspected by an authorized retailer of Genesis Branded products.

Intelligent Front-Lighting System disabled

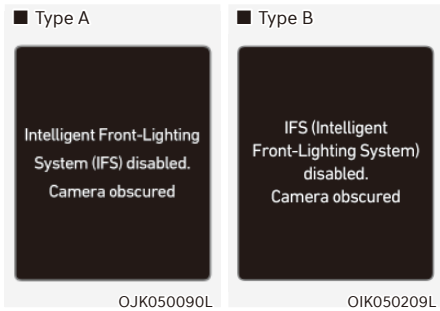

When the front view camera is covered with dirt, snow, or debris, Intelligent Front-Lighting System may temporarily not work properly. If this occurs, the ‘Intelligent Front-Lighting System (IFS) disabled. Camera obscured’ (or ‘IFS (Intelligent Front-Lighting System) disabled. Camera obscured’) warning message will appear on the cluster.

The system will operate normally when such dirt, snow or debris is removed.

Intelligent Front-Lighting System may not properly operate in an area (for example, open terrain) where any objects or vehicles are not detected after turning on the engine.

Also, even though a warning message does not appear on the cluster, the system may not properly operate.

Limitations of Intelligent Front-Lighting System

Intelligent Front-Lighting System may not work properly in the following situations:

- Light from a vehicle is not detected because of lamp damage, or because it is hidden from sight, etc.
- Headlamp of a vehicle is covered with dust, snow or water.
- A vehicle’s headlamps are off but the fog lamps are on and etc.
- There is a lamp that has a similar shape as a vehicle’s lamp.
- Headlamps have been damaged or not repaired properly.
- Headlamps are not aimed properly.
- Driving on a narrow curved road, rough road, uphill or downhill.
- Vehicle in front is partially visible on a crossroad or curved road.
- There is a traffic light, reflecting sign, flashing sign or mirror ahead.
- There is a temporary reflector or flash ahead (construction area).
- The road conditions are bad such as being wet, iced or covered with snow.
- A vehicle suddenly appears from a curve.
- The vehicle is tilted from a flat tire or is being towed.
- There are many street lights or the ambient light is bright.
- Light from a vehicle is not detected because of exhaust fume, smoke, fog, snow, etc.
- The front windshield is covered with foreign substance.

**CAUTION**

- Never install any accessories or stickers on the front windshield, or tint the front windshield.
- If the front view camera have been replaced or repaired, the system may need to be calibrated. We recommend that you have your vehicle inspected by an authorized retailer of Genesis Branded products.
- Pay extreme caution to keep the front view camera dry, and do not remove or damage related parts of the Intelligent Front-Lighting System.
- Never place any reflective objects (for example, white paper, mirror) over the dashboard. Any light reflection may prevent the system from functioning properly.

**WARNING**

- At times, Intelligent Front-Lighting System may not work properly. The system is for your convenience only. It is the responsibility of the driver for safe driving practices and always check the road conditions for your safety.
- When the system does not operate normally, switch the headlamp position manually between high beam and low beam.

HIGH BEAM ASSIST (HBA) (IF EQUIPPED)

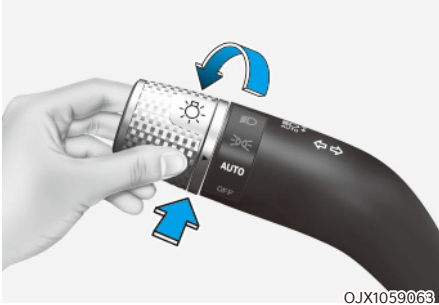

OJX1059063

High Beam Assist will automatically adjust the headlamp range (switches between high beam and low beam) depending on the brightness of detected vehicles and certain road conditions.

Detecting sensor

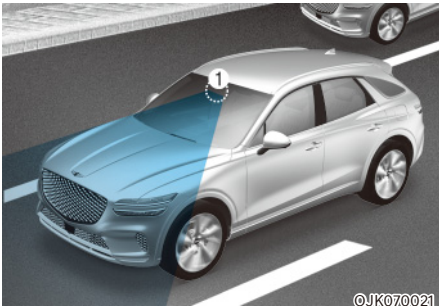

OJK070021

[1] : front view camera

The front view camera is used as a detecting sensor to detect ambient light and brightness while driving.

Refer to the picture above for the detailed location of the detecting sensor.

NOTICE

- Always keep the front view camera in good condition to maintain optimal performance of High Beam Assist.
- For more details on the precautions of the front view camera, refer to “Forward Collision-Avoidance Assist (FCA)” section in chapter 7.

High Beam Assist settings

Setting features

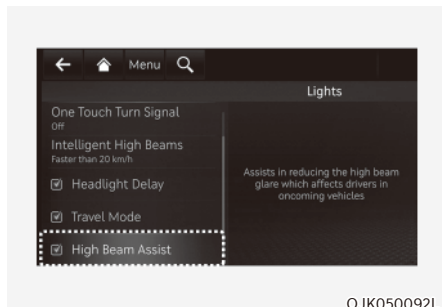

OJK050092L

With the Engine Start/Stop button in the ON position, select ‘Lights → High Beam Assist (or HBA (High Beam Assist))’ from the Settings menu to turn on High Beam Assist and deselect to turn off the system.

WARNING

For your safety, change the Settings after parking the vehicle at a safe location.

High Beam Assist operation

Display and control

- After selecting 'High Beam Assist' in the Settings menu, High Beam Assist will operate by following the procedure below.
 - Place the headlamp switch in the AUTO position and push the headlamp lever towards the instrument cluster. The High Beam Assist (AUTO) indicator light will illuminate on the cluster and High Beam Assist will be enabled.
 - When High Beam Assist is enabled, high beam will turn on when vehicle speed is above 40 km/h (25 mph). When vehicle speed is below 25 km/h (15 mph), high beam will not turn on.
 - The High Beam (HBA) indicator light will illuminate on the cluster when high beam is on.
- When High Beam Assist is operating, if the headlamp lever or switch is used, High Beam Assist operates as follow:
 - If the headlamp lever is pulled towards you when the high beam is off, the high beam will turn on without High Beam Assist canceled. When you let go of the headlamp lever, the lever will move to the middle and the high beam will turn off.
 - If the headlamp lever is pulled towards you when the high beam is on by High Beam Assist, low beam will be on and the system will turn off.
 - If the headlamp switch is placed from AUTO to another position (headlamp/position/off), High Beam Assist will turn off and the corresponding lamp will turn on.

- When High Beam Assist is operating, high beam switches to low beam if any of the following conditions occur:
 - When the headlamp of an oncoming vehicle is detected.
 - When the tail lamp of a vehicle in front is detected.
 - When the headlamp or tail lamp of a motorcycle or a bicycle is detected.
 - When the surrounding ambient light is bright enough that high beams are not required.
 - When streetlights or other lights are detected.

High Beam Assist malfunction and limitations

High Beam Assist malfunction

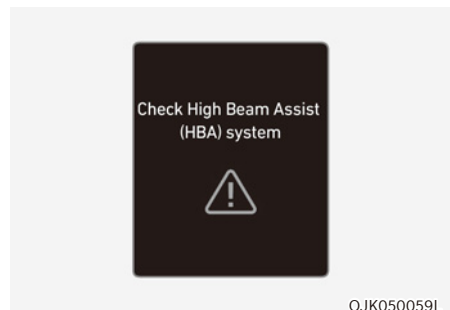

When High Beam Assist is not working properly, the 'Check High Beam Assist (HBA) system' warning message will appear and  warning light will illuminate on the cluster. We recommend that the system be inspected by an authorized retailer of Genesis Branded products.

Limitations of High Beam Assist

High Beam Assist may not work properly in the following situations:

- Light from an oncoming or front vehicle is not detected because of lamp damage, or because it is hidden from sight, etc.
- Headlamp of an oncoming or front vehicle is covered with dust, snow or water.
- A front vehicle's headlamps are off but the fog lamps are on, etc.
- There is a lamp that has a similar shape as a vehicle's lamp.
- Headlamps have been damaged or not repaired properly.
- Headlamps are not aimed properly.
- Driving on a narrow curved road, rough road, uphill or downhill.
- Vehicle in front is partially visible on a crossroad or curved road.
- There is a traffic light, reflecting sign, flashing sign or mirror ahead.
- There is a temporary reflector or flash ahead (construction area).
- The road conditions are bad such as being wet, iced or covered with snow.
- A vehicle suddenly appears from a curve.
- The vehicle is tilted from a flat tire or is being towed.
- Light from an oncoming or front vehicle is not detected due to obstacles in the air such as exhaust fume, smoke, fog, snow, or water spray or blizzard on the road, or fogging in the lamp, etc.



WARNING

- **At times, High Beam Assist may not work properly. High Beam Assist is for your convenience only. It is the responsibility of the driver for safe driving practices and always check the road conditions for your safety.**
- **When High Beam Assist does not operate normally, change the headlamp position manually between high beam and low beam.**



Information

For more details on the limitations of the Front View Camera, refer to “Forward Collision-Avoidance Assist (FCA)” section in chapter 7.

WIPERS AND WASHERS

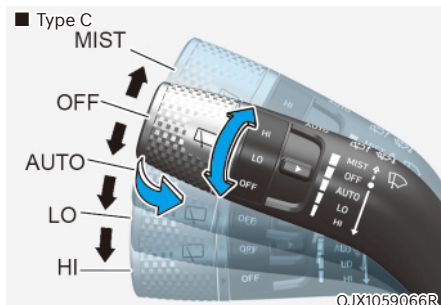
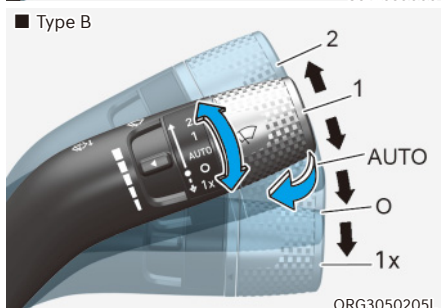
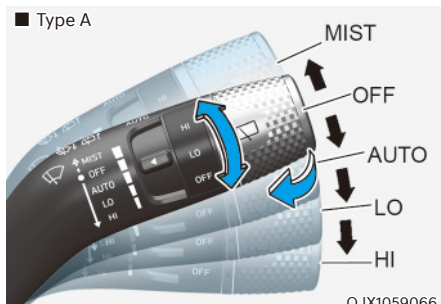

Front windshield wipers

Operates as follows when the Engine Start/Stop button is in the ON position.

MIST (1x) : For a single wiping cycle, push the lever upward (or downward) and release. The wipers will operate continuously if the lever is held in this position.

OFF (O) : Wiper is not in operation.

AUTO : The rain sensor located on the upper end of the windshield glass senses the amount of rainfall and controls the wiping cycle for the proper interval. The more it rains, the faster the wiper operates. When the rain stops, the wiper stops. To vary the speed setting, turn the speed control knob.

LO (1) : The wiper runs at a lower speed.

HI (2) : The wiper runs at a higher speed.

i Information

If there is heavy accumulation of snow or ice on the windshield, defrost the windshield for about 10 minutes, or until the snow and/or ice is removed before using the windshield wipers to ensure proper operation.

If you do not remove the snow and/or ice before using the wiper and washer, it may damage the wiper and washer system.

AUTO (Automatic) control

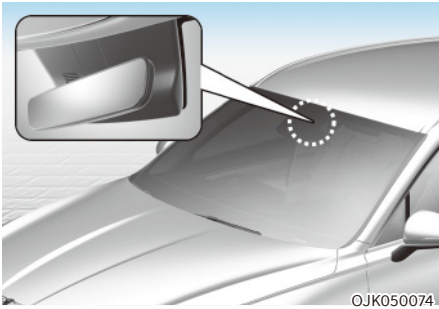

The rain sensor located on the upper end of the windshield glass senses the amount of rainfall and controls the wiping cycle for the proper interval.

The wiper operation time will be automatically controlled depends on rainfall.

When the rain stops, the wiper stops.

To vary the sensitivity setting, turn the sensitivity control knob.

If the wiper switch is set in AUTO mode when the Engine Start/Stop button is in the ON position, the wiper will operate once to perform a self-check of the system. Set the wiper to the OFF (O) position when the wiper is not in use.

WARNING

To avoid personal injury from the windshield wipers, when the engine is running and the windshield wiper switch is placed in the AUTO mode:

- Do not touch the upper end of the windshield glass facing the rain sensor.
- Do not wipe the upper end of the windshield glass with a damp or wet cloth.
- Do not put pressure on the windshield glass.

NOTICE

- When washing the vehicle, set the wiper switch in the OFF (O) position to stop the auto wiper operation. The wiper may operate and be damaged if the switch is set in the AUTO mode while washing the vehicle.
- Do not remove the sensor cover located on the upper end of the passenger side windshield glass. Damage to system components could occur and may not be covered by your vehicle warranty.
- Because of using a photo sensor, temporary malfunction could occur according to sudden ambient light change made by stone and dust while driving.

Front windshield washers

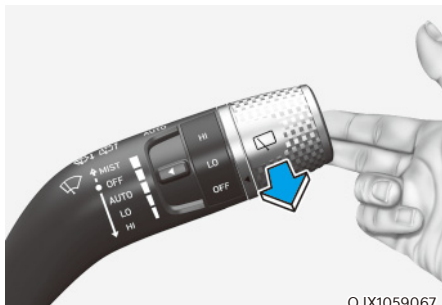

OJX1059067

In the OFF (O) position, pull the lever gently toward you to spray washer fluid on the windshield and to run the wipers 1-3 cycles. The spray and wiper operation will continue until you release the lever. If the washer does not work, you may need to add washer fluid to the washer fluid reservoir.

Recirculating air when washer fluid is used

When washer fluid is used, in order to reduce any objectionable scent of the washer fluid from entering the cabin, recirculation mode and air conditioning are automatically activated depending on the outside temperature. If you select fresh mode while the function is operating, the function will resume after a certain amount of time. It may not work in some conditions such as cold weather or engine OFF.

For more details, refer to “Climate Control Additional Features” section in this chapter.

WARNING

When the outside temperature is below freezing, **ALWAYS** warm the windshield using the defroster to help prevent the washer fluid from freezing on the windshield and obscuring your vision which could result in an accident and serious injury or death.

NOTICE

- To prevent possible damage to the washer pump, do not operate the washer when the fluid reservoir is empty.
- To prevent possible damage to the wipers or windshield, do not operate the wipers when the windshield is dry.
- To prevent damage to the wiper arms and other components, do not attempt to move the wipers manually.
- To prevent possible damage to the wipers and washer system, use anti-freezing washer fluids in the winter season or cold weather.

Rear window wiper and washer

■ Type A

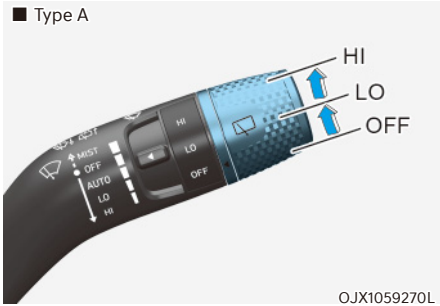

■ Type B

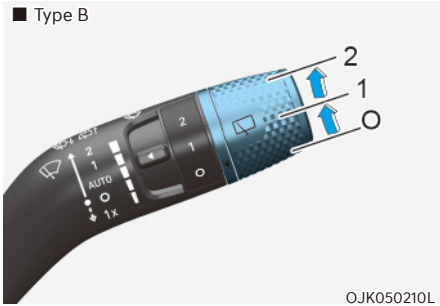

■ Type C

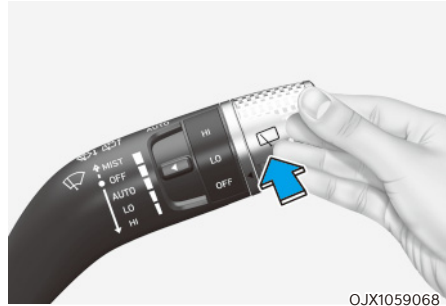
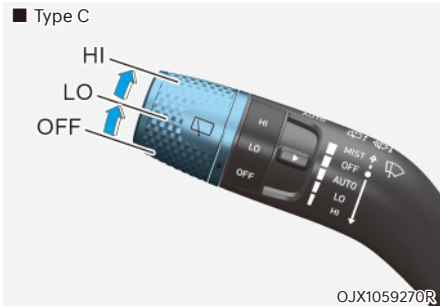

Push the lever away from you to spray rear washer fluid and to run the rear wipers 1-3 cycles. The spray and wiper operation will continue until you release the lever.

Auto rear wiper

The rear wiper will operate while the vehicle is in reverse with the front wiper ON by selecting the function from the Settings menu in the infotainment system screen. Select:

- Setup → Vehicle Settings → Convenience → Auto Rear Wiper (in R)

For detailed information, scan the QR code in a separately supplied simple manual.

The rear window wiper and washer switch is located at the end of the wiper and washer switch lever. Turn the switch to the desired position to operate the rear wiper and washer.

HI (2) – High wiper speed

LO (1) – Low wiper speed

OFF (0) – Off

AUTOMATIC CLIMATE CONTROL SYSTEM

- Front seat
 - Front seat control



- Rear seat control (if equipped)



OJK050103L/OJK050104

Front seat control

1. Driver's temperature control
2. Passenger's temperature control
3. Fan speed control
4. Driver's mode selection
5. Passenger's mode selection
6. AUTO (automatic control)
7. OFF (system off)
8. Front windshield defroster
9. Air intake control

10. SYNC
11. Rear window defroster
12. A/C (air conditioning)
13. Rear control

Rear seat control

1. Temperature control
2. Mode selection
3. AUTO
4. OFF (system off)
5. Climate control information screen

i Information

Use a clean soft microfiber cloth to gently wipe any finger prints off the touch screen.

- Rear seat (if equipped)
 - Rear seat control



OJK050100

1. Fan speed control
2. Temperature control
3. OFF (system off)
4. AUTO (automatic control)
5. Mode selection

i Information

Temperature and Mode selection (air flow direction) can be controlled from the rear seat. However, if 'Setup → Vehicle Settings → Climate → Climate Features → Lock the Rear Climate Control' is selected, the rear climate control can be operated only from the front seat. Deselect 'Lock the Rear Climate Control' before using it from the rear seats.

Automatic temperature control mode

The Automatic Climate Control System is controlled by setting the desired temperature.

1. Select AUTO.

The mode selection, fan speed, air intake and air-conditioning will be controlled automatically by the temperature setting you select.

2. When the climate control system is being automatically controlled, fan speed can be selected (Low/Medium/High).

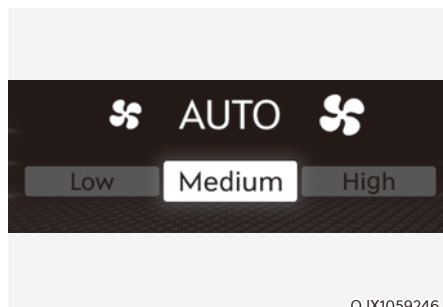

OJX1059246

- High: Use when quick heating or cooling is preferred with higher fan speed capability.
- Medium: Use when medium fan speed is preferred for cooling or heating with moderate fan speed capability.
- Low: Use when low fan speed is preferred for cooling or heating with lower fan speed capability.

3. Turn the temperature control knob to the desired temperature. If the temperature is set to the lowest setting (Lo), the air conditioning system will operate continuously. After the interior has cooled sufficiently, adjust the knob to a higher temperature set point whenever possible.

To turn the automatic operation off, select any function of the following:

- Mode selection (for Europe)
- Front windshield defroster (Press the button one more time to deselect the front windshield defroster function. The 'AUTO' sign will illuminate on the climate information screen once again.)
- Fan speed control
- A/C (air conditioning) (except Europe)

The selected function will be controlled manually while other functions operate automatically.

For your convenience and to improve the efficiency of the climate control, use the AUTO button and set the temperature to 22°C (72°F).

To change the temperature unit from °C to °F or °F to °C:

Select 'Setup → General Settings → Unit → Temperature Unit → °C/°F' from the Settings menu in the infotainment system screen.

i Information

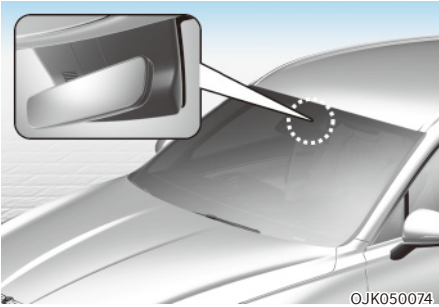

Never place anything near the ambient light/solar sensor to ensure better control of the heating and cooling system.

Manual temperature control mode

The heating and cooling system can be controlled manually by selecting functions other than AUTO. In this case, the system works sequentially according to the order of the functions selected.

When selecting any other functions except AUTO while using automatic operation, the functions not selected will be controlled automatically.

1. Start the vehicle.
2. Set the mode to the desired position.
To improve the effectiveness of heating and cooling, select the mode according to the following:

- Heating:
- Cooling:

3. Set the temperature control to the desired position.
4. Set the air intake control to Fresh or Recirculation mode.
5. Set the fan speed control to the desired speed.
6. If air conditioning is desired, turn the air conditioning system on.
7. Select AUTO to revert back to full automatic control of the system.

The climate control system settings will be maintained, even when the vehicle is turned off. However, the climate control system settings will be initialized when the battery has been discharged, or when the cables have been disconnected.

In this case, adjust the climate control system settings again.

Mode selection

■ Front seat

- Front seat control



- Rear seat control

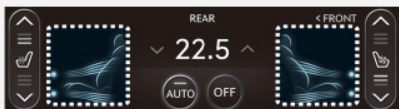

OJK050105L/OJK050106

Front seat mode selection

- Touch the air flow direction on the climate control information screen to select air flow direction.
- Touch SYNC and when the SYNC indicator light turns off, the air flow direction of the driver's seat, passenger seat, and rear seat can be controlled individually. However, passengers and rear seats cannot select .
- Touch REAR (1) to control the rear seat mode selection from the front seats.
- You may select 2~3 modes at the same time.

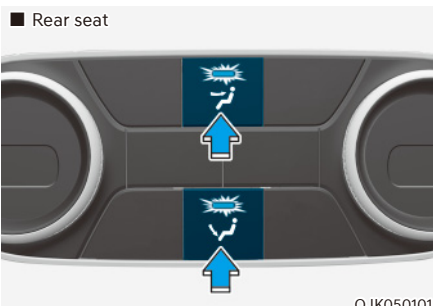

OJK050101

Rear seat mode selection

- Press the button to select the direction of the air flow to the desired position.
- You may select 2 modes at the same time.

■ Left-hand drive

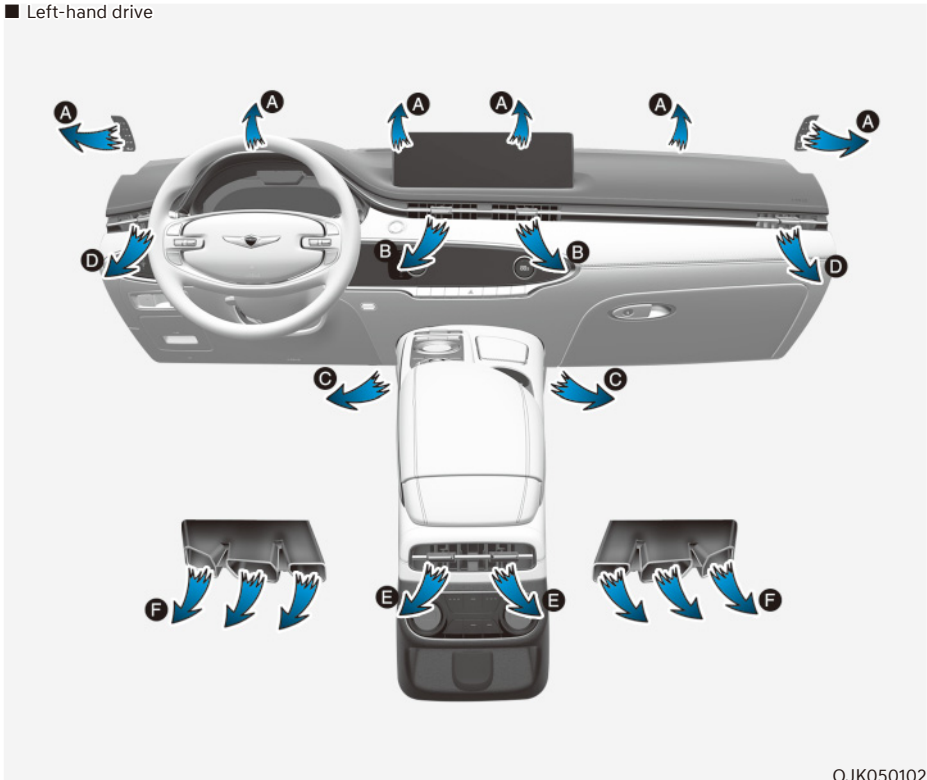

OJK050102

Air flow direction

The mode selection Icon or button controls the direction of the air flow through the ventilation system.

■ Right-hand drive

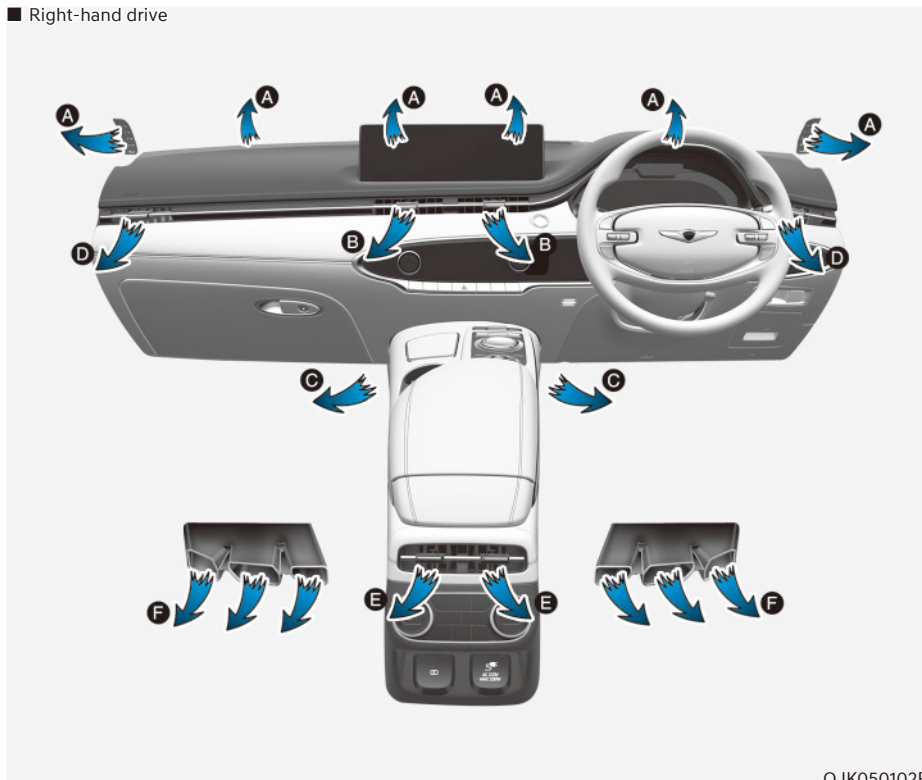

OJK050102R

Air flow direction

The mode selection Icon or button controls the direction of the air flow through the ventilation system.

- Front seat



Most of the air flow is directed to the windshield.



Air flow is directed toward the upper body and face. Additionally, each outlet can be controlled to direct the air discharged from the outlet.



Most of the air flow is directed to the floor, with a small amount of the air being directed to the windshield and side window defrosters.

- Rear seat



Air flow is directed toward the upper body and face.



Most of the air flow is directed to the floor.

Information

Two to three air flow modes can be selected at the same time.

Front windshield defroster

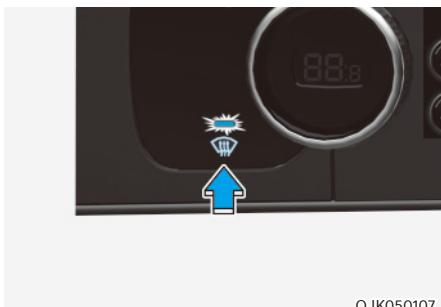

OJK050107

Defrost-level (A, D)

Press the button, and the indicator light will illuminate and the windshield defroster indicator will appear on the climate control information screen.

Most of the air flow is directed to the windshield with a small amount of air directed to the side window defrosters.

When Defogging logic is enabled, Fresh mode is selected and air conditioning is selected according to outside temperature.

Press the button, the indicator light will turn off and the previous settings will be selected.

Instrument panel vents

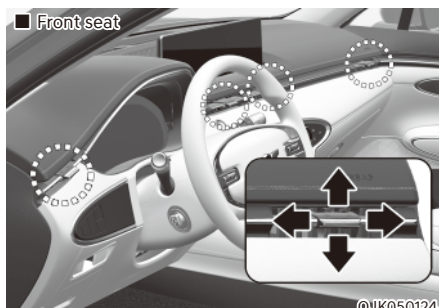

©JK050124

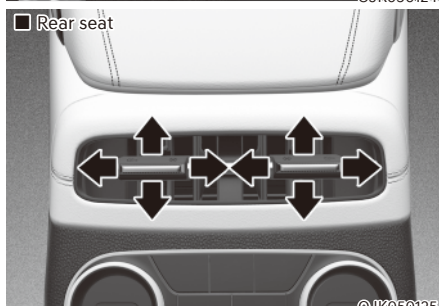

©JK050125

The instrument panel vent air flow can be directed up/down or left/right using the vent adjustment lever.

The air flow can also be CLOSED using the vent adjustment lever.

Move the lever away horizontally from the seat to close until the levers click and lock. Slightly move the lever toward the sitting position to unlock and open.

Temperature control

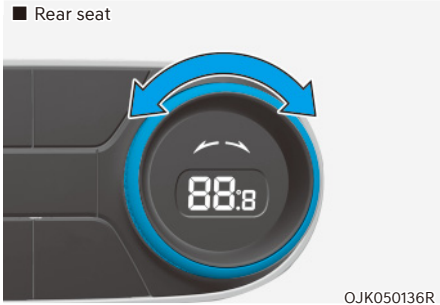
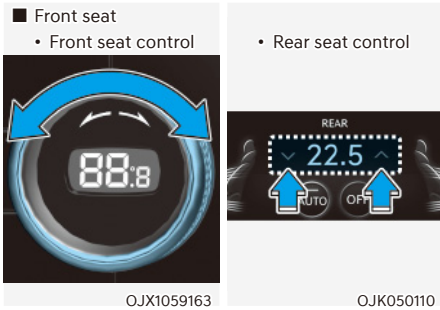

Turn the knob to the right to increase the temperature. Turn the knob to the left to decrease temperature.

Also, touch the \wedge or \vee icon to select the temperature for rear seats from the front seats.

The temperature can be increased or decreased by increments of 0.5°C (1°F) for each incremental location. When set to the lowest temperature setting, the air conditioning will operate continuously to quickly cool the interior of the vehicle initially. After interior temperature has been cooled down sufficiently, select AUTO and set the temperature to 22 °C (72 °F).

SYNC

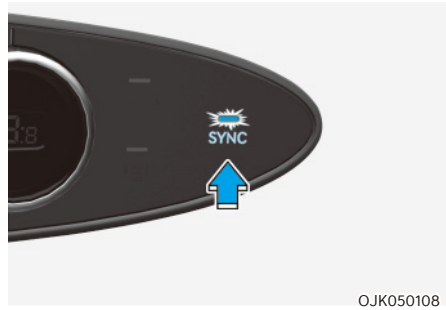

Adjusting the temperature and air flow direction equally

Press SYNC (indicator light ON), the rear seat's temperature and air flow direction will be adjusted same as the driver's control. You can also turn the SYNC function on or off by touching the air flow direction of the driver's seat and the passenger seat at the same time on the front climate control information screen.

Adjusting the temperature and air flow direction individually

Press SYNC (indicator light OFF), the front and rear seat's temperature and air flow direction will be adjusted individually.

Air intake control



OJK050109

Air intake control is used to select either Fresh mode (outside air) or Recirculation mode (cabin air).

Recirculation mode



When Recirculation mode is selected, air from the passenger compartment will be recirculated through the system and heated or cooled according to the function selected.

Fresh mode



When Fresh mode is selected, air enters the vehicle from outside and is heated or cooled according to the function selected.

i Information

Operating the system primarily in Fresh mode is recommended. Use Recirculation mode temporarily only when needed. Prolonged operation of the heater in Recirculation mode and without the air conditioning ON can cause fogging of the windshield. In addition, prolonged use of the air conditioning ON in Recirculation mode may result in excessively dry, dehumidified air in the cabin and may promote formation of musty vent odor due to stagnant air.

! WARNING

- Continued use of the climate control system operation in Recirculation mode for a prolonged period of time may cause drowsiness to the occupants in the cabin. This may lead to loss of vehicle control which may lead to an accident.
- Continued use of the climate control system operation in Recirculation mode with the air conditioning OFF may allow humidity to increase inside the cabin. This may cause condensation to accumulate on the windshield and obscure visibility.
- Do not sleep in your vehicle or remain parked in your vehicle with the windows up and either the heater or the air conditioning ON for prolonged periods of time. Doing so may increase the levels of carbon dioxide in the cabin which may lead to serious injury or death.

Fan speed control

- Front seat
 - Front seat control



- Rear seat

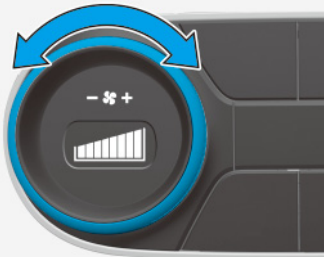

The fan speed can be set to the desired speed by touching the or icon, or by turning the fan speed control knob. More air is delivered with higher fan speeds. Pressing the OFF icon or button turns off the fan.

Information

To help improve microphone voice input sound, fan speed may automatically slow down for a couple of minutes when you activate voice recognition or hands free.

NOTICE

Operating the fan when the Engine Start/Stop button is in the ON position could cause the battery to discharge. Operate the fan when the engine is running.

Air conditioning

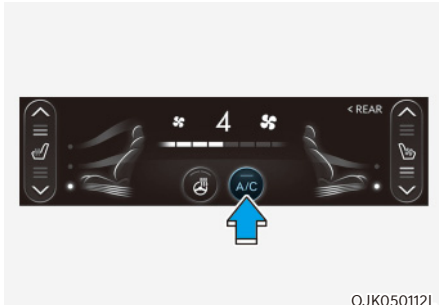

Touch the A/C icon to manually turn the air conditioning on (indicator light ON) and off.

OFF mode



Touch the OFF icon or press the OFF button to turn the climate control system off. You can still operate mode selection and air intake control as long as the Engine Start/Stop button is in the ON position.

System operation

Cooling / Ventilation

1. Select the Face Level (👤) mode.
2. Set the air intake control to fresh or recirculation mode.
3. Set the temperature control to the desired position.
4. Set the fan speed control to the desired speed.

Heating

1. Select the Floor Level (👤) mode.
2. Set the air intake control to fresh or recirculation mode.
3. Set the temperature control to the desired position.
4. Set the fan speed control to the desired speed.
5. If desired, turn the air conditioning ON with the temperature control knob set to heat in order to dehumidify the air before it enters into the cabin.

If the windshield fogs up, select the Front Defrost (👤) mode.

Operation Tips

- To keep dust or unpleasant fumes from entering the vehicle through the ventilation system, temporarily set the air intake control to the recirculation mode. Return the control to the to Fresh mode when the unpleasant air outside has diminished. This will help keep the driver alert and comfortable.
- To help prevent the inside of the windshield from fogging, set the air intake control to fresh mode and the fan speed to the desired position, turn on the air conditioning system, and adjust the temperature control to the desired temperature.

Air conditioning

Your Genesis Branded Vehicle air conditioning system is filled with R-134a or R-1234yf refrigerant.

1. Start the vehicle.
2. Touch the A/C icon.
3. Set the mode to the Face Level (👤) mode.
4. Set the air intake control to Recirculation mode temporarily to allow the cabin to cool quickly. When the desired temperature in the cabin is reached, change the air intake control back to Fresh mode.
5. Adjust the fan speed control and temperature control to maintain maximum comfort.

When maximum cooling is desired, set the temperature control to the lowest position, then set the fan speed control to the highest setting.

NOTICE

When using the air conditioning system, monitor the engine temperature gauge closely while driving up hills or in heavy traffic when outside temperatures are high. Air conditioning system operation when climbing a steep grade or in high outside ambient temperatures can cause engine overheating. Continue to use the fan, but turn the air conditioning system off if the engine temperature gauge indicates engine overheating.

Air conditioning system operation tips

- If the vehicle has been parked in direct sunlight during hot weather, open the windows for a short time to let the hot air inside the vehicle escape.
- After sufficient cooling has been achieved, switch back from recirculation mode to fresh mode.
- To help reduce moisture inside of the windows on rainy or humid days, decrease the humidity inside the vehicle by operating the air conditioning system with the windows and sunroof closed.
- Use the air conditioning system every month only for a few minutes to ensure maximum system performance.
- If you operate air conditioner excessively, the difference between the temperature of the outside air and that of the windshield could cause the outer surface of the windshield to fog up, causing loss of visibility. In this case, set the mode selection to the 🌬️ position and fan speed control to the lowest speed.

System maintenance

Cabin air filter

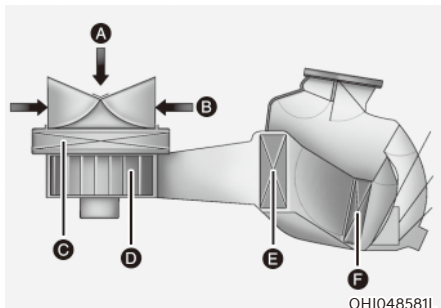

[A] : Outside air, [B] : Recirculated air
 [C] : Climate control air filter, [D] : Blower
 [E] : Evaporator core, [F] : Heater core

The cabin air filter is installed behind the glove box. It filters the dust or other pollutants that enter the vehicle through the heating and air conditioning system.

We recommend that the cabin air filter be replaced by an authorized retailer of Genesis Branded products according to the maintenance schedule. If the vehicle is being driven in severe conditions such as dusty or rough roads, more frequent cabin air filter inspections and changes are required.

If the air flow rate suddenly decreases, we recommend that the system be inspected at an authorized retailer of Genesis Branded products.

Checking the amount of air conditioner refrigerant and compressor lubricant

When the amount of refrigerant is low, the performance of the air conditioning is reduced. Overfilling also reduces the performance of the air conditioning system.

Therefore, if abnormal operation is found, we recommend that the system be inspected by an authorized retailer of Genesis Branded products.

NOTICE

It is important that the correct type and amount of oil and refrigerant is used. Otherwise, damage to the compressor and abnormal system operation may occur. To prevent damage, the air conditioning system in your vehicle should only be serviced by trained and certified technicians.



WARNING

Vehicles equipped with R-134a



Since the refrigerant is operated at very high pressure, the air conditioning system should only be serviced by trained and certified technicians.

All refrigerants should be reclaimed with proper equipment.

Venting refrigerants directly to the atmosphere is harmful to individuals and environment. Failure to heed these warnings can lead to serious injuries.

WARNING

Vehicles equipped with R-1234yf



Since the refrigerant is mildly flammable and operated at high pressure, the air conditioning system should only be serviced by trained and certified technicians. It is important that the correct type and amount of oil and refrigerant are used.

All refrigerants should be reclaimed with proper equipment.

Venting refrigerants directly to the atmosphere is harmful to individuals and environment. Failure to heed these warnings can lead to serious injuries.



Air Conditioning refrigerant label

You can find out which air conditioning refrigerant is applied to your vehicle on the label located inside of the hood.

■ Example

• Type A



OHYK059004

• Type B



OHYK059001

Each symbols and specification on the air conditioning refrigerant label is represented as below:



1. Classification of refrigerant
2. Amount of refrigerant
3. Classification of compressor lubricant
4. Caution
5. Flammable refrigerant
6. To require registered technician to service air conditioning system
7. Service manual

WINDSHIELD DEFROSTING AND DEFOGGING



WARNING

Windshield heating

Do not use the  position during cooling operation in extremely humid weather. The difference between the temperature of the outside air and that of the windshield could cause the outer surface of the windshield to fog up, causing loss of visibility could cause an accident resulting in serious injury or death. In this case, set the mode selection to the  position and fan speed control to a lower speed.

- For maximum defrost performance, set the temperature control to the highest temperature setting and the fan speed control to the highest setting.
- If warm air to the floor is desired while defrosting or defogging, set the mode to the floor-defrost position.
- Before driving, clear all snow and ice from the windshield, rear window, outside rearview mirrors, and all side windows.
- Clear all snow and ice from the hood and air inlet in the cowl grill to improve heater and defroster efficiency and to reduce the probability of fogging up the inside of the windshield.

NOTICE

If the engine temperature is still cold after starting, then a brief engine warm up period may be required for the vented air flow to become warm or hot.

To defog inside windshield

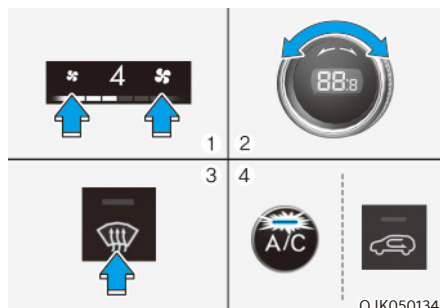

1. Select the desired fan speed.
2. Select the desired temperature.
3. Press the defroster button (.
4. Fresh mode will be selected automatically.

Check to make sure the air intake control is in Fresh mode. If the air intake control indicator light is illuminated, press the button once to enable Fresh mode (indicator light OFF).

If the  position is selected, the fan speed is automatically increased.

To defrost outside windshield

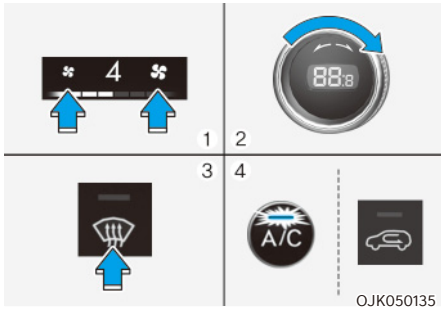

1. Set the fan speed to the highest (extreme right) position.
2. Set the temperature to the extreme hot (HI) position.
3. Press the defroster button (☀️).
4. Fresh mode will be selected automatically.

Check to make sure the air intake control is in Fresh mode. If the air intake control indicator light is illuminated, press the button once to enable Fresh mode (indicator light OFF).

If the ☀️ position is selected, lower fan speed is adjusted to a higher fan speed.

Defogging logic

To reduce the probability of fogging up the inside of the windshield, the air intake or air conditioning are controlled automatically according to certain conditions such as ☀️ positions. To cancel or reset the defogging logic, do the following.

1. Press the Engine Start/Stop button to the ON position.
2. Press the defroster button (☀️) or (🌀).
3. While touching the A/C icon, press the air intake control button at least 5 times within 3 seconds.

The air intake control indicator will blink 3 times to indicate that the defogging logic has been disabled. Repeat the steps again to re-enable the defogging logic.

If the battery has been discharged or disconnected, it resets to the defog logic status.

Rear window defroster

NOTICE

To prevent damage to the rear window defroster conducting elements bonded to the inside surface of the rear window, never use sharp instruments or window cleaners containing abrasives to clean the window.

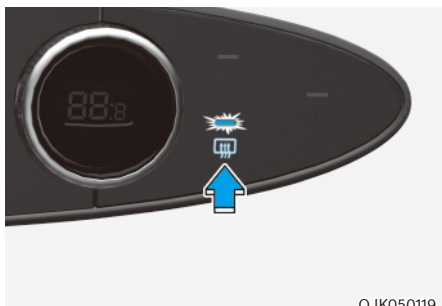

OJK050119

The defroster heats the window to remove frost, fog and thin ice from the interior and exterior of the rear window, while the engine is running.

- To activate the rear window defroster, press the rear window defroster button located in the center control panel. The indicator on the rear window defroster illuminates when the defroster is on.
- To turn off the defroster, press the rear window defroster button again.

i Information

- If there is heavy accumulation of snow on the rear window, brush it off before operating the rear defroster.
- The rear window defroster automatically turns off after approximately 20 minutes or when the Engine Start/Stop button is in the OFF position.

Outside rearview mirror defroster

If your vehicle is equipped with the rearview mirror defrosters, they will operate at the same time you turn on the rear window defroster.

CLIMATE CONTROL ADDITIONAL FEATURES

Auto defogging system

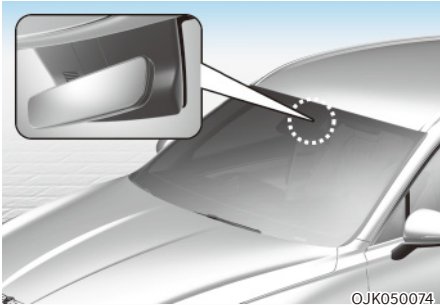

Auto defogging helps reduce the possibility of fogging up the inside of the windshield by automatically sensing the moisture on inside the windshield.

The auto defogging system operates when the heater or air conditioning is on.

Information

The auto defogging system may not operate normally, when the outside temperature is below -10°C (14°F).



When the Auto Defogging System operates, the indicator will illuminate.

If a high amount of humidity is detected in the vehicle, the Auto Defogging System will be enabled. The following steps will be performed automatically:

- Except Europe

Step 1) Air conditioning will turn ON.

Step 2) Air intake control will change to Fresh mode.

Step 3) Mode will change to defrost to direct airflow to the windshield.

Step 4) Fan speed will be set to MAX.

- For Europe

Step 1) Air conditioning will turn ON.

Step 2) Air intake control will change to Fresh mode.

Step 3) Fan speed will be set to MAX.

Step 4) Mode will change to defrost to direct airflow to the windshield.

If the air conditioning is off or recirculation mode is manually selected while Auto Defogging System is ON, the Auto Defogging System indicator will blink 3 times to signal that the manual operation has been canceled.

Turning the Auto Defogging System ON or OFF

Climate control system

Press the front windshield defroster button for 3 seconds when the Engine Start/Stop button is in the ON position. When the Auto Defogging System is turned off, the ADS OFF symbol will blink 3 times and ADS OFF will be displayed on the climate control information screen.

When the Auto Defogging System is turned on, the ADS OFF symbol will blink 6 times without a signal.

Infotainment system

Auto Defogging System can be turned on and off by selecting 'Setup → Vehicle Settings → Climate → Defog/Defrost Options → Auto Defog' from the infotainment system screen.

For detailed information, scan the QR code in a separately supplied simple manual.



Information

- **When the air conditioning is turned on by Auto Defogging System, if you try to turn off the air conditioning, the indicator will blink 3 times and the air conditioning will not be turned off.**
- **To maintain the effectiveness and efficiency of the Auto Defogging System, do not select Recirculation mode while the system is operating.**
- **When Auto Defogging System is operating, fan speed adjustment, temperature adjustment, and air intake control selection are all disabled.**

NOTICE

Do not remove the sensor cover located on the upper end of the windshield glass.

Damage to system parts could occur and may not be covered by your vehicle warranty.

Auto dehumidify (if equipped)

To increase cabin air quality and reduce windshield misting, recirculation mode switches off automatically after about 5 to 30 minutes, depending on the outside temperature, and the air intake will change to fresh mode.

Turning Auto Dehumidify ON or OFF

Climate control system

To turn the Auto Dehumidify feature on or off, select Face level (👤) mode and press the air intake control (👉) button at least five times within three seconds. When Auto Dehumidify is turned on, the air intake control button indicator will blink 6 times. When turned off, the indicator will blink 3 times.

Infotainment system

Auto Dehumidify can be turned on and off by selecting 'Setup → Vehicle Settings → Climate → Automatic Ventilation → Auto Dehumidify' from the infotainment system screen.

For detailed information, scan the QR code in a separately supplied simple manual.

Recirculating air when washer fluid is used

Recirculation mode automatically activates to reduce any objectionable scent of the washer fluid from entering the cabin when the windshield washer is used.

Turning Activate upon Washer Fluid Use ON or OFF

Climate control system

To turn the Activate upon Washer Fluid Use feature on or off, select Floor level (🚶) mode, and then press the air intake control (🌀) button four times within two seconds while pressing the A/C icon.

When Activate upon Washer Fluid Use ON is turned on, the air intake control button indicator will blink 6 times. When turned off, the indicator will blink 3 times.

Infotainment system

Activate upon Washer Fluid Use can be turned on and off by selecting 'Setup → Vehicle Settings → Climate → Recirculate Air → Activate upon Washer Fluid Use (or Interlocking washer fluid)' from the infotainment system screen.

For detailed information, scan the QR code in a separately supplied simple manual.

However, in cold weather to prevent the windshield from fogging up, the recirculation mode may not be selected.

Sunroof inside air recirculation (if equipped)

When the sunroof is opened, fresh mode will be automatically selected. At this time, if you press the air intake control button, recirculation mode will be selected but will change back to fresh mode after 3 minutes. When the sunroof is closed, the air intake position will return to the original position that was selected.

Auto. Controls That Use Climate Control Settings (for driver's seat)

The temperature of the driver's seat warmer, air ventilated seat and heated steering wheel is automatically controlled depending on the inside and outside temperature of the vehicle when the engine is running.

To use these features, it must be enabled from the Settings menu in the infotainment system screen. Select:

- Setup → Vehicle Settings → Seat → Heated/Ventilated Features → Heated/Ventilated Features → Auto. Controls That Use Climate Control Settings

For more details on Auto Comfort Control, refer to "Seat Warmers" and "Air ventilation seats" section in chapter 3 and "Heated Steering Wheel" section in this chapter.

STORAGE COMPARTMENT

WARNING

Never store cigarette lighters, propane cylinders, or other flammable/explosive materials in the vehicle. These items may catch fire and/or explode if the vehicle is exposed to hot temperatures for extended periods.

WARNING

ALWAYS keep the storage compartment covers closed securely while driving. Items inside your vehicle are moving as fast as the vehicle. If you have to stop or turn quickly, or if there is a crash, the items may fly out of the compartment and may cause an injury if they strike the driver or a passenger.

NOTICE

To avoid possible theft, do not leave valuables in the storage compartments.

Center console storage

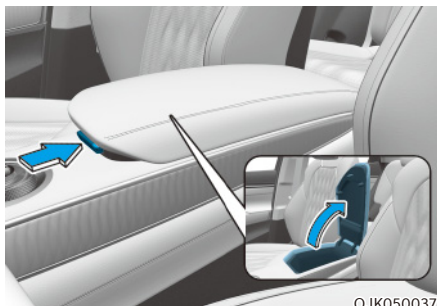

OJK050037

To open:
Press the button.

Glove box

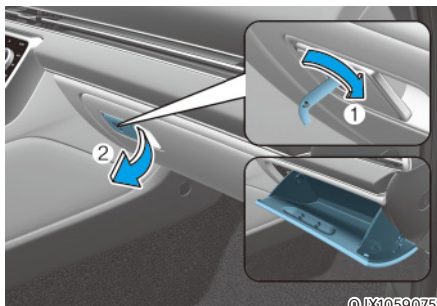

©JX1059075

The glove box can be locked and unlocked with the mechanical key (1).

To open:
Pull the lever (2).

WARNING

ALWAYS close the glove box door after use.

An open glove box door can cause serious injury to the passenger in an accident, even if the passenger is wearing a seat belt.

Sunglass holder

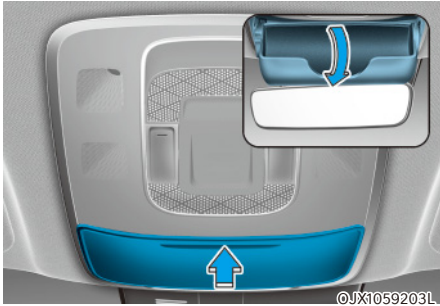

To open:

Push and release the cover and the holder will slowly open. Place your sunglasses in the compartment door with the lenses facing out.

To close:

Push back into position.

Make sure the sunglass holder is closed while driving.

WARNING

- Do not keep objects except sunglasses inside the sunglass holder. Such objects can be thrown from the holder in the event of a sudden stop or an accident, possibly injuring the passengers in the vehicle.
- Do not open the sunglass holder while the vehicle is moving. The rear view mirror of the vehicle can be blocked by an open sunglass holder.
- Do not put the glasses forcibly into a sunglass holder. It may cause personal injury if you try to open it forcibly when the glasses are jammed in holder.

Mobile phone holder

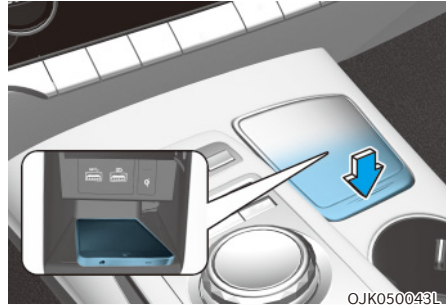

Store your phone or other small items while driving.

NOTICE

The item you have stored such as a mobile phone may not fit in the mobile phone holder depending on the size or shape of the item. Do not forcibly push items into the holder and close the cover. The mobile phone holder may not open, or it may damage the stored item. In addition, do not forcibly open the mobile phone storage cover, when it is jammed with a stored item inside.

INTERIOR FEATURES

Cup holder

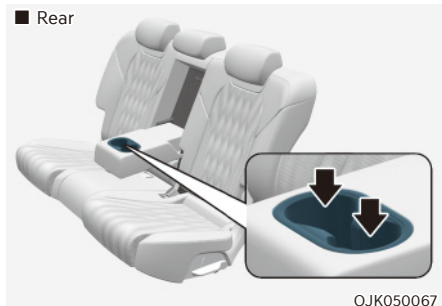
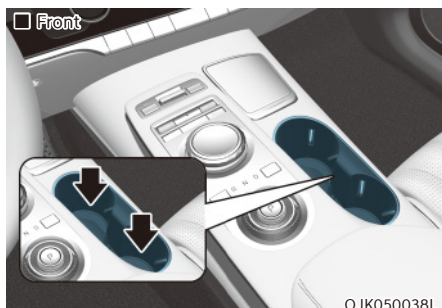

Cups or small beverages cups may be placed in the cup holders.



WARNING

- Avoid abrupt starting and braking when the cup holder is in use to prevent spilling your drink. If hot liquid spills, you could be burned. Such a burn to the driver could cause loss of vehicle control resulting in an accident.
- Do not place uncovered or unsecured cups, bottles, cans, etc., in the cup holder containing hot liquid while the vehicle is in motion. Injuries may result in the event of a sudden stop or collision.
- Only use soft cups in the cup holders. Hard objects can injure you in an accident.



WARNING

Keep cans or bottles out of direct sun light and do not put them in a hot vehicle. It may explode.

NOTICE

- Keep your drinks sealed while driving to prevent spilling your drink. If liquid spills, it may get into the vehicle's electrical/electronic system and damage electrical/electronic parts.
- When cleaning spilled liquids do not use hot air to blow out or dry the cup holder. This may damage the interior.

Ashtray (if equipped)



To open cover:
Press the cover and it will slowly open.

To clean the ashtray:
The plastic receptacle should be removed by lifting the plastic ashtray receptacle upward and pulling it out.

WARNING

Putting lit cigarettes or matches in an ashtray with other combustible materials may cause a fire.

Sunvisor

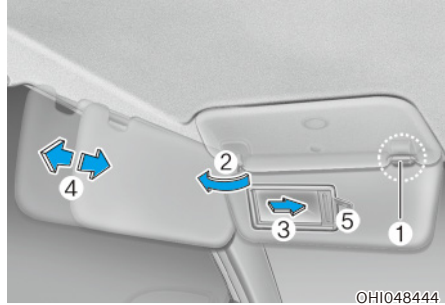

To use the sunvisor, pull it downward.
To use the sunvisor to block the sun from the side window, pull it downward, release it from the bracket (1) and swing it to the side (2) towards the window.
To use the vanity mirror, pull down the sunvisor and slide the mirror cover (3).
Adjust the sunvisor forward or backward (4) as needed (if equipped). Use the ticket holder (5) to hold tickets.
Close the vanity mirror cover securely and return the sunvisor to its original position after use.

WARNING

For your safety, do not block your view when using the sunvisor.

NOTICE

The tab (5) adjacent to the vanity mirror on the sunvisor can be used for toll road tickets or self parking tickets. Use caution when inserting tickets into the ticket holder to avoid damage. Refrain from putting several tickets in the ticket holder as this could also damage the retaining tab.

Power outlet

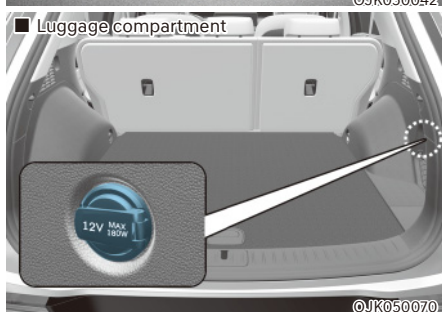

The power outlet is designed to provide power for mobile telephones or other devices designed to operate with vehicle electrical systems. The devices should draw less than 180 watts with the engine running.



WARNING

Avoid electrical shocks. Do not place your fingers or foreign objects (pin, etc.) into a power outlet or touch the power outlet with a wet hand.

NOTICE

To prevent damage to the power outlets:

- Use the power outlet only when the engine is running and remove the accessory plug after use. Using the accessory plug for prolonged periods of time with the engine off could cause the battery to discharge.
- Only use 12 volts electric accessories which are less than 180 watts in electric capacity.
- Adjust the air-conditioner or heater to the lowest operating level when using the power outlet.
- Close the cover when not in use.
- Some electronic devices can cause electronic interference when plugged into a vehicle's power outlet. These devices may cause excessive audio static and malfunctions in other electronic systems or devices used in your vehicle.
- Push the plug in as far as it will go. If good contact is not made, the plug may overheat and the fuse may open.
- Plug in battery equipped electrical/electronic devices with reverse current protection. The current from the battery may flow into the vehicle's electrical/electronic system and cause system malfunction.

USB charger (if equipped)

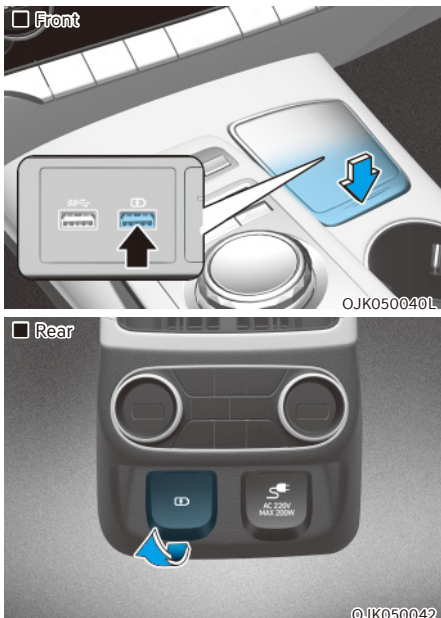

The USB charger is designed to recharge batteries of small size electrical devices using a USB cable.

The electrical devices can be recharged when the Engine Start/Stop button is in the ON or START position.

The battery charging state may be monitored on the electrical device.

Disconnect the USB cable from the USB port after use.

- A smart phone or a tablet PC may get warmer during the re-charging process. It does not indicate any malfunction with the charging system.
- A smart phone or a tablet PC, which adopts a different re-charging method, may not be properly re-charged. In this case, use an exclusive charger of your device.
- The charging terminal is only to recharge a device. Do not use the charging terminal either to turn ON an audio or to play media in the infotainment system.

NOTICE

- **Use the USB charger when the engine is running. Using the USB charger for prolonged periods of time with the engine off could cause the battery to discharge.**
- **To prevent damage to the USB charger:**
 - **Do not insert foreign objects or spill liquid into the outlet. The USB charging terminal may be damaged.**
 - **Do not use devices with current consumption exceeding 2,100 mA (2.1 A).**

AC Inverter (if equipped)



The AC inverter supplies 220 volts/200 watts electric power to operate electric accessories or equipment.

i Information

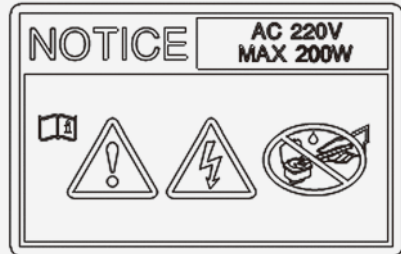

OJX1070289L

- **Rated voltage : AC 220 volts**
- **Maximum electric power : 200 watts**
- **In order to avoid an electrical system failure, electric shock, etc., be sure to read owner's manual before use.**
- **Be sure to close the cover except the time of use.**

! WARNING

To reduce a risk of serious or fatal injuries:

- **Do not use a heated electric device such as a coffeepot, toaster, heater, iron, etc.**
- **Do not insert foreign objects into the outlet and do not touch the outlet as you may get shocked.**
- **Do not let children touch the AC inverter.**

NOTICE

- To prevent the battery from being discharged, do not use the AC inverter while the engine is not running.
- When not using the AC inverter, make sure to close the AC inverter cover.
- After using an electric accessory or equipment, pull the plug out. Leaving the accessory or equipment plugged in for a long time may cause battery discharge.
- Do not use an electric accessory or equipment the power consumption of which is greater than 220 volts/200 watts.
- Some electric accessories or equipment can cause electronic interference. It may cause excessive audio noise and malfunctions in other electric systems or devices in the vehicle.
- Do not use broken electric accessories or equipment, which may damage the AC inverter and electrical systems of the vehicle.
- Do not use two or more electric accessories or equipment at the same time. It may cause damage to the electrical systems of the vehicle.
- When the input voltage is lower, outlet LED will blink and the AC inverter will turn off automatically. If the input voltage goes up to normal, the AC inverter will turn on again.

Wireless smart phone charging system (if equipped)

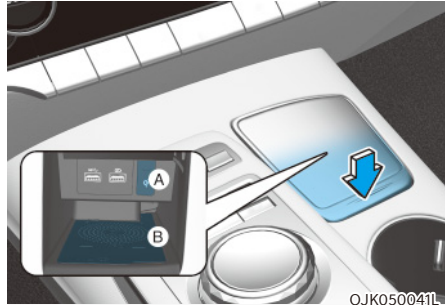

[A] : Indicator light, [B] : Charging pad

On certain models, the vehicle comes equipped with a wireless smart phone charger.

The system is available when all doors are closed, and when the Engine Start/ Stop button is in the ON or START position.

Charging smart phone

The wireless smart phone charging system charges only the Qi-enabled smart phones (Qi). Read the label on the smart phone accessory cover or visit your smart phone manufacturer's website to check whether your smart phone supports the Qi technology.

The wireless charging process starts when you put a Qi-enabled smart phone on the wireless charging unit.

1. Remove other items, including the smart key, from the wireless charging unit. If not, the wireless charging process may be interrupted. Place the smart phone on the center of the charging pad.

2. The indicator light is orange when the smart phone is charging. The indicator light will turn blue when phone charging is complete.
3. You can turn ON or OFF the wireless charging function from the Settings menu in the infotainment system screen. Select:
 - Setup → Vehicle → Convenience → Wireless Charging

For detailed information, scan the QR code in a separately supplied simple manual.

If your smart phone is not charging:

- Slightly change the position of the smart phone on the charging pad.
- Make sure the indicator light is orange.

The indicator light will blink orange for 10 seconds if there is a malfunction in the wireless charging system.

In this case, temporarily stop the charging process, and re-attempt to charge your smart phone again.

The system warns you with a message on the LCD display if the smart phone is still on the wireless charging unit after the vehicle is turned OFF and the front door is opened.

For some manufacturer's smart phones, the system may not warn you even though the smart phone is left on the wireless charging unit. This is due to the particular characteristic of the smart phone and not a malfunction of the wireless charging.

NOTICE

- **The wireless smart phone charging system may not support certain smart phones, which are not verified for the Qi specification (Qi).**
- **When placing your smart phone on the charging pad, position the phone in the middle of the mat for optimal charging performance. If your smart phone is off to the side, the charging rate may be less and in some cases the smart phone may experience higher heat conduction.**
- **In some cases, the wireless charging may stop temporarily when the smart key is used, either when starting the vehicle or locking/unlocking the doors, etc.**
- **When charging certain smart phones, the charging indicator may not change to blue when the smart phone is fully charged.**
- **The wireless charging process may temporarily stop, when temperature abnormally increases inside the wireless smart phone charging system. The wireless charging process restarts, when temperature falls to a certain level.**
- **The wireless charging process may temporarily stop when there is any metallic item, such as a coin, between the wireless smart phone charging system and smart phone.**

- When charging some smart phones with a self-protection feature, the wireless charging speed may decrease and the wireless charging may stop.
- If the smart phone has a thick cover, the wireless charging may not be possible.
- If the smart phone is not completely contacting the charging pad, wireless charging may not operate properly.
- Some magnetic items like credit cards, phone cards or rail tickets may be damaged if left with the smart phone during the charging process.
- When any smart phone without a wireless charging function or a metallic object is placed on the charging pad, a small noise may sound. This small sound is due to the vehicle discerning compatibility of the object placed on the charging pad. It does not affect your vehicle or the smart phone in any way.

i Information

If the Engine Start/Stop button is in the OFF position, the charging also stops.

Clock

The clock can be set from the infotainment system.

For detailed information, scan the QR code in a separately supplied simple manual.

⚠ WARNING

Do not attempt to adjust the clock while driving. Doing so may result in distracted driving which may lead to an accident involving personal injury or death.

Coat hook

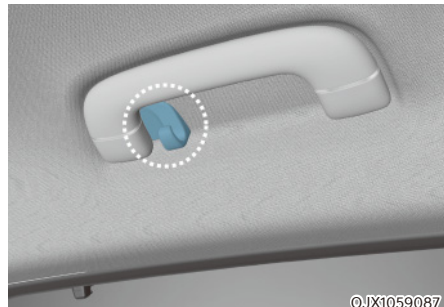

These hooks are not designed to hold large or heavy items.

 **WARNING**



Do not hang other objects such as hangers or hard objects except clothes. Also, do not put heavy, sharp or breakable objects in the clothes pockets. In an accident or when the curtain air bag is inflated, it may cause vehicle damage or personal injury.

Floor mat anchor(s)

ALWAYS use the Floor Mat Anchors to attach the front floor mats to the vehicle. The anchors on the front floor carpet keep the floor mats from sliding forward.

 **WARNING**

Do not overlay additional mats or liners over the floor mats. If using All Weather mats, remove the carpeted floor mats before installing them. Only use floor mats designed to connect to the anchors.

 **WARNING**

The following must be observed when installing ANY floor mat to the vehicle.

- Ensure to remove a protective film attached on the carpet before attaching a floor mat on the front floor carpet. Otherwise, the floor mat may move freely on the protective film and it could result in unintentional braking or accelerating.
- Ensure that the floor mats are securely attached to the vehicle's floor mat anchor(s) before driving the vehicle.
- Do not use ANY floor mat that cannot be firmly attached to the vehicle's floor mat anchors.
- Do not stack floor mats on top of one another (for example, all-weather rubber mat on top of a carpeted floor mat). Only a single floor mat should be installed in each position.

IMPORTANT Your vehicle was manufactured with driver's side floor mat anchors that are designed to securely hold the floor mat in place. To avoid any interference with pedal operation, Genesis Branded Vehicle recommends that the Genesis floor mat designed for use in your vehicle be installed.

Rear side window sunshades (if equipped)

Use the rear side window sunshade to block external light coming through the rear window glass.

Manual sunshades

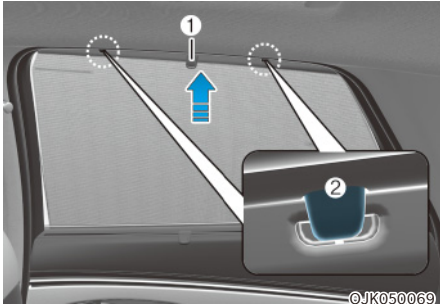

1. Lift the sunshade by the handle (1).
2. Hang the sunshade on both sides of the hook (2). If the sunshade is hung on one side of the hook, the sunshade may be wrinkled.

NOTICE

- Do not hang any other object except the rear side window sunshade on the hooks.
- If you pull the rear side window sunshade or apply force to return the sunshade to its original position after use, you may find the sunshade wrinkled or out of shape. To lower the sunshade, be sure to put the handle downward and slowly return the sunshade to its original position.
- Sunshades may not work properly if foreign objects (coins, toys, cookies, etc.) are stuck in the door. Be careful that the foreign objects do not get into the door.

Luggage net holder (if equipped)



To keep items from shifting in the luggage compartment, you can use the 4 holders located in the luggage board to attach the luggage net.

Make sure the luggage net is securely attached to the holders in the luggage board.

If necessary, we recommend that you contact your authorized retailer of Genesis Branded products to obtain a luggage net.

WARNING

Avoid eye injury. DO NOT overstretch the luggage net. ALWAYS keep your face and body out of the luggage net's recoil path. DO NOT use the luggage net when the strap has visible signs of wear or damage.

Use the luggage net to keep only light items from shifting in the luggage compartment.

Cargo security screen (if equipped)



Use the cargo security screen to cover items stored in the cargo area.

Using the cargo security screen

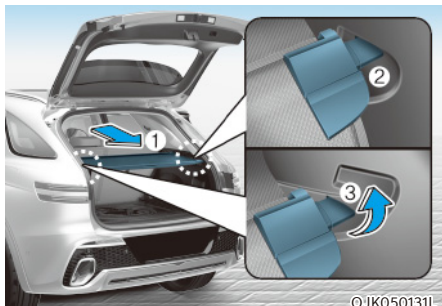

1. Pull the cargo security screen towards the rear of the vehicle by the handle (1).
2. Insert the guide pin (2) into the guide (3).

i Information

Pull out the cargo security screen with the handle in the center to prevent the guide pin from falling out of the guide.

When the cargo security screen is not in use:

1. Pull the cargo security screen rearward and up to release it from the guides.
2. The cargo security screen will automatically slide back in.

i Information

The cargo security screen may not automatically slide back in if the cargo security screen is not fully pulled out. Pull the cargo screen out all the way and then slowly allow the screen to retract back in.

NOTICE

Since the cargo security screen may be damaged or malformed, do not put luggage on it when it is used.

! WARNING

- Do not place objects on the cargo security screen. Such objects may be thrown about inside the vehicle and possibly injure vehicle occupants during an accident or when braking.
- Never allow anyone to ride in the luggage compartment. It is designed for luggage only.
- Maintain the balance of the vehicle and locate the weight as forward as possible.

Removing the cargo security screen



1. Push one side of the cargo screen inward to compress the spring and release the screen from the vehicle.
2. While the spring is compressed, pull out the cargo security screen.
3. Open the luggage tray and keep the cargo security screen in the tray.

Removing the cargo security screen from the luggage tray

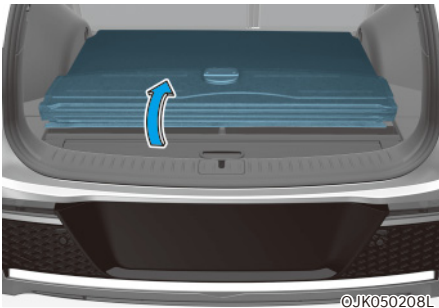

1. Pull up the screen board.

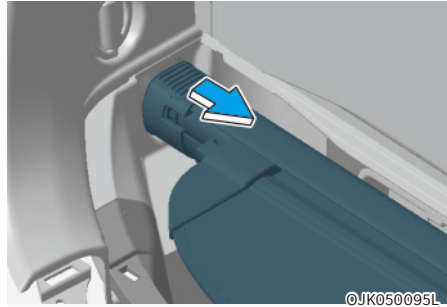

2. Push in the guide pin.

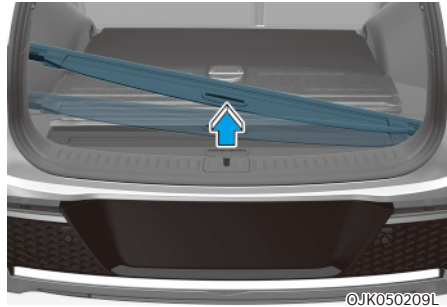

3. While pushing the guide pin, pull out the cargo security screen.

EXTERIOR FEATURES

Roof side rails



OJK050076

If your vehicle comes with roof side rails, then roof side rails crossbars can be installed on top of your vehicle.

The roof side rails crossbars are an accessory and are available at your local retailer of Genesis Branded products.

NOTICE

If the vehicle is equipped with a sunroof, be sure not to position cargo onto the roof side rails in such a way that it could interfere with sunroof operation.

NOTICE

- When carrying cargo on the roof side rails, take the necessary precautions to make sure the cargo does not damage the roof of the vehicle.
- When carrying large objects on the roof side rails, make sure they do not exceed the overall roof length or width.



WARNING

- The following specification is the maximum weight that can be loaded onto the roof side rails. Distribute the load as evenly as possible onto the roof side rails and secure the load firmly.

Loading cargo or luggage in excess of the specified weight limit on the roof side rails may damage your vehicle.

ROOF SIDE RAILS	100 kg (220 lbs.) EVENLY DISTRIBUTED
-----------------	---

- The vehicle center of gravity will be higher when items are loaded onto the roof side rails. Avoid sudden starts, braking, sharp turns, abrupt maneuvers or high speeds that may result in loss of vehicle control or rollover resulting in an accident.
- Always drive slowly and turn corners carefully when carrying items on the roof side rails. Severe wind updrafts, caused by passing vehicles or natural causes, can cause sudden upward pressure on items loaded on the roof side rails. This is especially true when carrying large, flat items such as wood panels or mattresses. This could cause the items to fall off the roof side rails and cause damage to your vehicle or others around you.
- To prevent damage or loss of cargo while driving, check frequently before or while driving to make sure the items on the roof side rails are securely fastened.

INFOTAINMENT SYSTEM

NOTICE

- If you install an aftermarket HID head lamp, your vehicle's audio and electronic devices may not function properly.
- Prevent chemicals such as perfume, cosmetic oil, sun cream, hand cleaner, and air freshener from contacting the interior parts because they may cause damage or discoloration.

USB Port

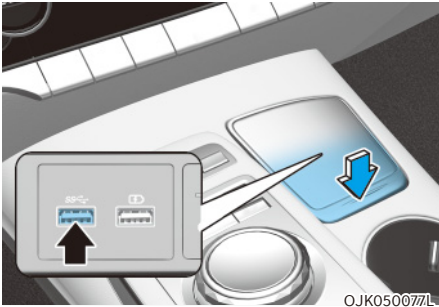

You can use a USB cable to connect audio devices to the vehicle USB port.

i Information

When using a portable audio device connected to the power outlet, noise may occur during playback. If this happens, use the portable audio device's power source.

Antenna

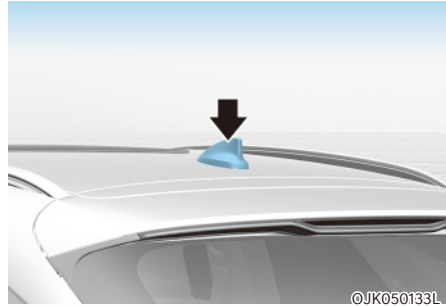

The shark fin antenna will receive AM, FM broadcast signals and transmit data.

Steering wheel remote controls

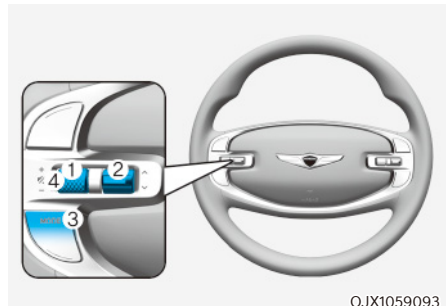

NOTICE

Do not operate multiple audio remote control buttons simultaneously.

VOLUME (VOL + / VOL -) (1)

- Rotate the VOLUME scroll up to increase volume.
- Rotate the VOLUME scroll down to decrease volume.

SEEK/PRESET (∧ / ∨) (2)

If the SEEK/PRESET switch is pressed up or down and held for 0.8 second or more, it will function in the following modes:

- **RADIO mode**
It will function as the AUTO SEEK select button. It will SEEK until you release the button.
- **MEDIA mode**
It will function as the FF/RW button.

If the SEEK/PRESET switch is pressed up or down, it will function in the following modes:

- **RADIO mode**
It will function as the PRESET STATION UP/DOWN button.
- **MEDIA mode**
It will function as the TRACK UP/DOWN button.

MODE (3)

Press the MODE button to toggle through Radio modes.

MUTE (🔇) (4)

- Press the MUTE(🔇) button to mute or activate the sound.

For detailed information, scan the QR code in a separately supplied simple manual.

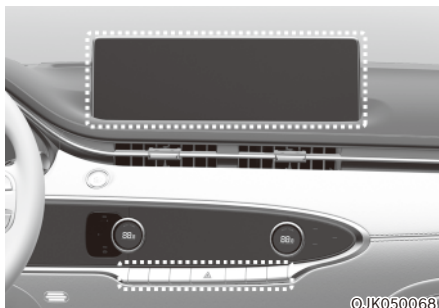
Infotainment system

For detailed information, scan the QR code in a separately supplied simple manual.

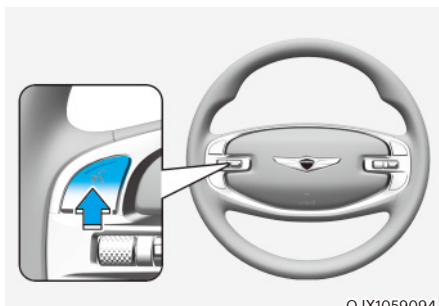
Voice recognition

For detailed information, scan the QR code in a separately supplied simple manual.

Bluetooth® Wireless Technology

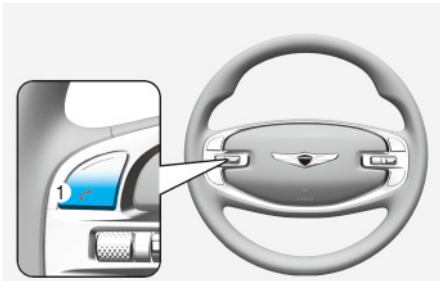

©JX1059095



©JX1059207L

- (1) Call / Answer / Call end button
- (2) Microphone

For detailed information, scan the QR code in a separately supplied simple manual.

CAUTION

To avoid driver distractions, do not excessively operate the device while driving the vehicle which may lead to an accident.

Lexicon premium sound system (if equipped)

CAUTION

Lexicon premium sound system is equipped with door speaker grills made of stainless steel. The grill surface can be heated when the vehicle is exposed to hot weather for a long period of time. Keep away from the speaker grill when it is hot.

BUILT-IN CAM (IF EQUIPPED)

Built-in Cam records the vehicle's front and rear images using the front Built-in Cam camera and rear view camera.

i Information

- **'On While Driving' or 'Driving Events' is disabled when a vehicle is first delivered. The driver must set up a specific recording condition.**
- **The description may differ depending on the software version installed on the vehicle. Check for the latest version software on the Built-in Cam update homepage, and update the latest version.**

Built-in Cam's settings

Settings features

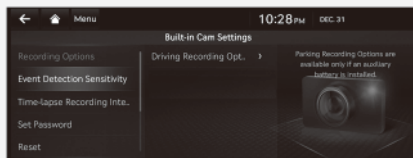

OJX1050217L



OJX1050216L

On While Driving and Driving Event

Select 'Drive Video Recordings' from the home screen, and then select 'Built-in Cam Settings' to choose whether to use 'On While Driving' and 'Driving Events'.

If 'Driving Events' is selected, you may also setup the sensitivity level, which determines whether or not to record at an event.

User Profile Link feature

- The settings of the Built-in Cam will change according to the Driver selected from the 'User Profile Settings' in the infotainment system screen.
- Settings that change depending on the Driver selected are 'On While Driving', 'Driving Events', 'Event Detection Sensitivity' and 'Time-Lapse Recording Interval'. However, recorded videos does not change depending on the Driver selected from the 'User Profile Settings'.

Built-in Cam operation

Operating condition of Built-in Cam

Built-in Cam will operate when 'On While Driving' or 'Driving Events' is selected from the Settings menu in the infotainment system screen while the Engine Start/Stop button is in the ON or START position.

Built-in Cam manual recording



Using the Built-in Cam manual recording button, the driver can record situations before and after the button is pressed.

When the driver presses the manual recording button while the engine is running, recording starts regardless of the Built-in Cam setting.

- Event recording: Press the button briefly to record events.
- Time-lapse recording: Press and hold the button to start Time-lapse video recording. Press and hold the button again to end recording.
 - Time-lapse recording can be used only when the engine is running. If you turn off the engine during recording, Time-lapse recording will end.
 - Time-lapse recording can be set from the 'Built-in Cam → Time-Lapse' menu in the infotainment system screen.

i Information

What is Time-lapse?

Time-lapse compresses images after recording each image frame at regular intervals and plays the image at high speed.

The recording interval (1 second/2 seconds/5 seconds) can be selected from the Time-lapse menu in the infotainment system. Recorded images are saved for up to 20 minutes, 40 minutes or 100 minutes according to the selected recording interval.

Built-in Cam operating status

Built-in Cam manual button

Built-in Cam operating status can be checked by the indicator light on the Built-in Cam manual recording button.

Operating status	Indicator light
On While Driving stored	On
Manual button event recording	Blinks interval of 2 sec.
Impact detection event recording	
Time-lapse recording	Blinks 5 times

Built-in Cam camera

The Built-in Cam operating status can be checked by the indicator light on the front Built-in Cam camera.

Operating status	Indicator light
'On While Driving' or 'Driving Events' is selected	Blinks interval of 2 sec.
'On While Driving' and 'Driving Events' are not selected	Off

Built-in Cam USB port

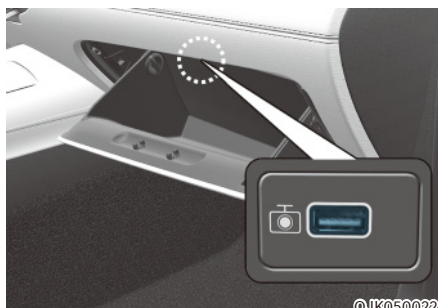

Using the Built-in Cam dedicated USB port, the driver can download stored videos by inserting a USB memory.

Built-in Cam screen

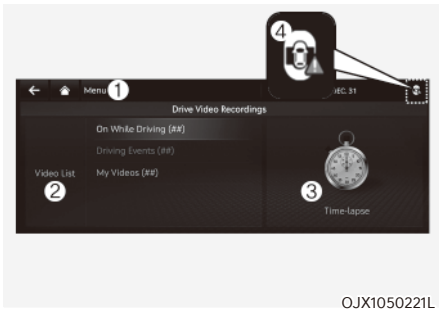

1. Menu: Displays menus such as video deletion and storage box copy. Basic setting of Built-in Cam can be set through the settings menu.
2. Recorded video list: 'On While Driving' recording and 'Driving Event' recording can be checked.
3. Time-lapse: Time-lapse recording is available only when the engine is on. If the driver turns off the engine, time-lapse turns off.
4. Check whether there is a problem with the front Built-in Cam camera and rear view camera
5. Provides thumbnail of the recorded video from the front Built-in Cam camera and rear view camera
6. Date of recorded files
7. Time of recorded files
8. Overall zoom in or zoom out
9. Delete, storage box copy and USB memory download
10. Playback control and selecting front and rear
11. Selecting playback time: Touch the screen and select playback time.

i Information

Using two fingers, pinch to make the screen smaller, and spread to make screen larger.



CAUTION

- If the USB memory connection is disconnected while downloading the video to the USB memory, the file in the USB memory can be damaged.
- Built-in Cam does not detect and record every situation or impact.
- During operation of 'Driving Events' (impact detection), the video may be stored due to impact caused by vehicle operation or use of device inside the vehicle.
- If the front Built-in Cam camera lens, rear view camera lens or windshield glass is unclean, the video cannot record properly. Keep the lens and windshield glass clean.
- The USB memory supports FAT16 / FAT32 / NTFS / exFAT format files. In some cases, it does not recognize specific USB memory properly.
- Old files are automatically deleted if there is not enough storage space. When videos are stored frequently due to driving long distance, frequent impact detection or Built-in Cam manual button operation, the files stored within a short period of time can be deleted automatically. Download important files or store the files if necessary.
- Videos are not stored while the system is being initialized.
- We recommend that important files are backed up.
- Stored video files can be deleted in case of software updates or repair. Have the files backed up before updates or repair.
- Video quality may deteriorate due to excessive window tinting.
- If the vehicle is handed over to another person due to used vehicle deal or rental, he or she should prevent personal information from leaking by deleting the stored videos.
- The order of stored files can change if the driver changes the time in the vehicle. Please check the stored file order before changing time settings.
- Time difference may occur depending on the video player used if the recorded file is downloaded to the computer and played.
- Be cautious that the system can be damaged when the front Built-in Cam camera and rear view camera is removed by force.
- If a warning message "Check drive video record system" appears on the cluster, we recommend that the vehicle be inspected by an authorized retailer of Genesis Branded products.



Information

Built-in Cam includes GPL, LGPL and other open source license software. All license notices including related source code are provided at <https://www.yuracorp.co.kr>.

If the driver requests on-board software open source code via opensource@genesis.com within 3 years after buying this product, a CD-ROM will be sent with the minimum cost covering storage device cost and delivery cost.

6. Driving your vehicle

Before driving.....	6-5
Before entering the vehicle	6-5
Before starting	6-5
Engine Start/Stop button	6-6
Engine Stop/Start button positions	6-7
Starting the engine.....	6-8
Turning off the engine.....	6-10
Remote start	6-11
Automatic transmission	6-12
Automatic transmission operation.....	6-12
LCD display messages (cluster).....	6-18
Paddle shifter (Manual shift mode).....	6-20
Good driving practices.....	6-21
Braking system.....	6-22
Power-assist brakes	6-22
Disc brakes wear indicator	6-22
High performance brake.....	6-23
Electronic Parking Brake (EPB).....	6-23
Auto Hold	6-27
Anti-lock Brake System (ABS).....	6-31
Electronic Stability Control (ESC)	6-32
Vehicle Stability Management (VSM)	6-35
Hill-Start Assist Control (HAC).....	6-36
Emergency Stop Signal (ESS).....	6-37
Multi-Collision Brake (MCB).....	6-37
Downhill Brake Control (DBC).....	6-38
Good braking practices.....	6-41
All Wheel Drive (AWD)	6-42
All Wheel Drive (AWD) operation	6-42
Emergency precautions.....	6-45
Electronic limited slip differential.....	6-47
Drive mode selection	6-47
Warning messages	6-47

Electronic control suspension.....	6-48
System malfunction	6-48
Electronically controlled suspension with road preview	6-48
System malfunction	6-49
Limitations of the system	6-49
Launch control	6-50
Prerequisite for activation	6-50
Launch Control activation	6-50
Limited use of Launch Control	6-51
Idle Stop and Go (ISG)	6-52
ISG system operation.....	6-52
ISG system off.....	6-54
Forced to Restart Engine	6-55
ISG malfunction.....	6-55
Calibrating the Battery Sensor	6-55
Coasting	6-57
Coasting setting	6-57
Coasting operating conditions.....	6-57
Coasting release conditions	6-58
Drive mode integrated control system (2WD)	6-59
Drive mode	6-59
Drive mode integrated control system (AWD)	6-61
Drive mode	6-61
Vehicle characteristic.....	6-63
Multi terrain mode	6-64

6. Driving your vehicle

Active sound design	6-64
Semi active engine mount	6-64
Special driving conditions.....	6-65
Hazardous driving conditions	6-65
Rocking the vehicle.....	6-65
Smooth cornering	6-66
Driving at night.....	6-66
Driving in the rain.....	6-66
Driving in flooded areas.....	6-67
Highway driving	6-67
Reducing the risk of a rollover.....	6-68
Winter driving.....	6-69
Snow or icy conditions.....	6-69
Winter precautions.....	6-72
Trailer towing.....	6-74
If you decide to pull a trailer?	6-75
Trailer towing equipment.....	6-78
Driving with a trailer.....	6-79
Maintenance when towing a trailer	6-82
Vehicle weight.....	6-83
Overloading	6-83



WARNING

Carbon monoxide (CO) gas is toxic. Breathing CO can cause unconsciousness and death.

Engine exhaust contains carbon monoxide which cannot be seen or smelled.

Do not inhale engine exhaust.

If at any time you smell engine exhaust inside the vehicle, open the windows immediately. Exposure to CO can cause unconsciousness and death by asphyxiation.

Be sure the exhaust system does not leak.

The exhaust system should be checked whenever the vehicle is raised to change the oil or for any other purpose. If you hear a change in the sound of the exhaust or if you drive over something that strikes the underneath side of the vehicle, we recommend that the exhaust system be checked as soon as possible by an authorized retailer of Genesis Branded products.

Do not run the engine in an enclosed area.

Letting the engine idle in your garage, even with the garage door open, is a hazardous practice. Run the engine only long enough to start the engine and to move the vehicle out of the garage.

Avoid idling the engine for prolonged periods with people inside the vehicle.

If it is necessary to idle the engine for a prolonged period with people inside the vehicle, be sure to do so only in an open area with the air intake set at “Fresh” and fan control set to high so fresh air is drawn into the interior.

Keep the air intakes clear.

To assure proper operation of the ventilation system, keep the ventilation air intakes located in front of the windshield clear of snow, ice, leaves, or other obstructions.

If you must drive with the tailgate open:

Close all windows.

Open instrument panel air vents.

Set the air intake control at “Fresh”, the air flow control at “Floor” or “Face”, and the fan control set to high.

BEFORE DRIVING

Before entering the vehicle

- Be sure all windows, outside mirror(s), and outside lights are clean and unobstructed.
- Remove frost, snow, or ice.
- Visually check the tires for uneven wear and damage.
- Check under the vehicle for any sign of leaks.
- Be sure there are no obstacles behind you if you intend to back up.

Before starting

- Make sure the hood, the tailgate, and the doors are securely closed and locked.
- Adjust the position of the seat and steering wheel.
- Adjust the inside and outside rearview mirrors.
- Verify all the lights work.
- Fasten your seat belt. Check that all passengers have fastened their seat belts.
- Check the gauges and indicators in the instrument panel and the messages on the instrument display when the Engine Start/Stop button is in the ON position.
- Check that any items you are carrying are stored properly or fastened down securely.



WARNING

To reduce the risk of **SERIOUS INJURY** or **DEATH**, take the following precautions:

- **ALWAYS** wear your seat belt. All passengers must be properly belted whenever the vehicle is moving. For more information, refer to “Seat Belts” section in chapter 3.
- Always drive defensively. Assume other drivers or pedestrians may be careless and make mistakes.
- Stay focused on the task of driving. Driver distraction can cause accidents.
- Leave plenty of space between you and the vehicle in front of you.



WARNING

NEVER drink or take drugs and drive.

Drinking or taking drugs and driving is dangerous and may result in an accident and **SERIOUS INJURY** or **DEATH**.

Drunk driving is the number one contributor to the highway death toll each year. Even a small amount of alcohol will affect your reflexes, perceptions and judgment. Just one drink can reduce your ability to respond to changing conditions and emergencies and your reaction time gets worse with each additional drink.

Driving while under the influence of drugs is as dangerous or more dangerous than driving under the influence of alcohol.

You are much more likely to have a serious accident if you drink or take drugs and drive. If you are drinking or taking drugs, don't drive. Do not ride with a driver who has been drinking or taking drugs. Choose a designated driver or call a taxi.

ENGINE START/STOP BUTTON



Whenever the front door is opened, the Engine Start/Stop button will illuminate and will go off 30 seconds after the door is closed.



WARNING

To turn the vehicle off in an emergency: Press and hold the Engine Start/Stop button for more than two seconds OR Rapidly press and release the Engine Start/Stop button three times (within three seconds).

If the vehicle is still moving, you can restart the vehicle without depressing the brake pedal by pressing the Engine Start/Stop button with the gear in the N (Neutral) position.



WARNING

- **NEVER** press the Engine Start/Stop button while the vehicle is in motion except in an emergency. This will result in the vehicle turning off and loss of power assist for the steering and brake systems. This may lead to loss of directional control and braking function, which could cause an accident.
- Before leaving the driver's seat, always make sure the gear is in the **P (Park)** position, set the parking brake, press the Engine Start/Stop button to the **OFF** position, and take the Smart Key with you. Unexpected vehicle movement may occur if these precautions are not followed.
- **NEVER** reach through the steering wheel for the Engine Start/Stop button or any other control while the vehicle is in motion. The presence of your hand or arm in this area may cause a loss of vehicle control resulting in an accident.

Engine Stop/Start button positions

Button Position	Action	Notes
OFF	To turn off the engine, press the Engine Start/Stop button with the vehicle shifted to P (Park). Note if the Engine Start/Stop button is pressed with the vehicle shifted to D (Drive) or R (Reverse), the gear will automatically shift to P (Park). If the Engine Start/Stop button is pressed with the gear shifted to N (Neutral), the Engine Start/Stop button will change to the ACC position. The steering wheel locks to protect the vehicle from theft.	If the steering wheel is not locked properly when you open the driver's door, the warning chime will sound.
ACC	Press the Engine Start/Stop button when the button is in the OFF position without depressing the brake pedal. Some of the electrical accessories are usable. The steering wheel unlocks.	<ul style="list-style-type: none"> • If you leave the Engine Start/Stop button in the ACC position for more than one hour, the battery power will turn off automatically to prevent the battery from discharging. • If the steering wheel doesn't unlock properly, the Engine Start/Stop button will not work. Press the Engine Start/Stop button while turning the steering wheel right and left to release.
ON	Press the Engine Start/Stop button while it is in the ACC position without depressing the brake pedal. The warning lights can be checked before the engine is started.	Do not leave the Engine Start/Stop button in the ON position when the engine is not running to prevent the battery from discharging.
START	To start the engine, depress the brake pedal and press the Engine Start/ Stop button with the gear shifted to the P (Park) or the N (Neutral) position. For your safety, start the engine with the gear shifted to the P (Park) position.	If you press the Engine Start/Stop button without depressing the brake pedal, the engine does not start and the Engine Start/Stop button changes as follows: OFF → ACC → ON → OFF or ACC

- * To prevent vehicle battery discharge, the Engine Start/Stop button changes to the OFF position when the Engine Start/Stop button is in the ACC or ON position with the gear in P (Park) for a certain period of time. When the function operates, the tail lamps will turn off. To use the tail lamps again, turn the headlamp switch located on the steering column to the OFF and ON position again.

Starting the engine



WARNING

- Always wear appropriate shoes when operating your vehicle. Unsuitable shoes, such as high heels, ski boots, sandals, flipflops, etc., may interfere with your ability to use the brake and accelerator pedals.
- Do not start the vehicle with the accelerator pedal depressed. The vehicle can move which can lead to an accident.
- Wait until the engine rpm is normal. The vehicle may suddenly move if the brake pedal is released when the RPM is high.



Information

- The vehicle will start by pressing the Engine Start/Stop button, only when the smart key is in the vehicle.
- Even if the smart key is in the vehicle, and when it is far away from the driver, the engine may not start.
- When the Engine Start/Stop button is in the ACC or ON position, if any door is open, the system checks for the smart key. When the smart key is not in the vehicle, the “” indicator will blink and the warning 'Key not in vehicle' will come on. When all doors are closed, the chime will also sound for about 5 seconds. Keep the smart key in the vehicle.

Starting the gasoline engine

1. Always carry the smart key with you.
2. Make sure the parking brake is applied.
3. Make sure the gear is shifted to P (Park) by pressing the P button.
4. Depress the brake pedal.
5. Press the Engine Start/Stop button.



Information

- Do not wait for the engine to warm up while the vehicle remains stationary. Start driving at moderate engine speeds. Steep accelerating and decelerating should be avoided.
- Always start the vehicle with your foot on the brake pedal. Do not depress the accelerator while starting the vehicle. Do not race the engine while warming it up.

Starting the diesel engine

To start the diesel engine when the engine is cold, it has to be pre-heated and then it has to be warmed up, before starting to drive.

1. Always carry the smart key with you.
2. Make sure the parking brake is applied.
3. Make sure the gear is shifted to P (Park) by pressing the P button.
4. Depress the brake pedal.
5. Press the Engine Start/Stop button.
6. Continue depressing the brake pedal until the glow indicator light (🔥) goes out.
7. When the glow indicator light (🔥) goes out, the engine will start.

***i* Information**

If the Engine Start/Stop button is pressed while the engine is pre-heating, the engine may start.

Starting and stopping the engine with turbocharger intercooler

1. Do not race or accelerate the engine immediately after starting the engine. If the engine is cold, idle for several seconds before sufficient lubrication is ensured in the turbo charger unit.
2. After high speed or extended driving that requires heavy engine load, idle the engine about 1 minute before turning the engine off. This idle time will allow the turbocharger to cool prior to shutting the engine off.

NOTICE

Do not turn off the engine immediately after it has been subjected to a heavy load. Doing so may cause severe damage to the engine or turbo charger unit.

NOTICE

To prevent damage to the vehicle:

- If the engine stalls while you are in motion, do not attempt to shift the gear to the P (Park) position.

If traffic and road conditions permit, you may put the gear in N (Neutral) while the vehicle is still moving and press the Engine Start/Stop button in an attempt to restart the engine.

- Do not push or tow your vehicle to start the vehicle.

NOTICE

To prevent damage to the vehicle:

Do not press the Engine Start/Stop button for more than 10 seconds except when the stop lamp fuse is blown.

When the stop lamp fuse is blown, you cannot normally start the engine. Replace the fuse with a new one. If you are not able to replace the fuse, you can start the engine by pressing and holding the Engine Start/Stop button for 10 seconds with the Engine Start/Stop button in the ACC position.

For your safety always depress the brake pedal before starting the vehicle.

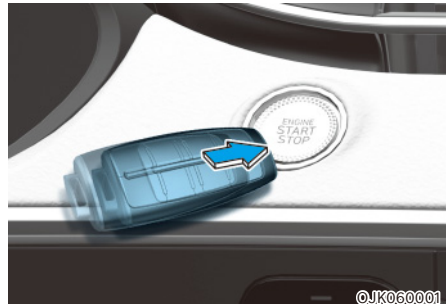

i Information

If the smart key battery is weak or the smart key does not work correctly, you can start the vehicle by pressing the Engine Start/Stop button with the smart key in the direction of the picture above.

Turning off the engine

1. Stop the vehicle and depress the brake pedal fully.
2. Press the P button to shift to P (Park).
3. Press the Engine Start/Stop button to the OFF position and apply the parking brake.

Remote start

■ Type A



OJX1069057L

■ Type B



OJX1069054L

You can start the vehicle using the Remote Start button of the smart key.

To start the vehicle remotely:

1. Press the door lock button within 10 m (32 feet) from the vehicle.
2. Press the remote start (Ω _{HOLD}) button for over 2 seconds within 4 seconds after locking the doors. The hazard warning lights will blink.
3. To turn off the remote start function, press the remote start (Ω _{HOLD}) button once.
 - The remote start (Ω _{HOLD}) button may not operate if the smart key is not within 10 m (32 feet).
 - The vehicle will not remotely start if the engine hood or tailgate is opened.
 - The vehicle must be in P (Park) for the remote start function to start.
 - The engine turns off if you get in the vehicle without a registered smart key.
 - The engine turns off if you do not get in the vehicle within 10 minutes after remotely starting the vehicle.
 - Do not idle the engine for a long period.

AUTOMATIC TRANSMISSION

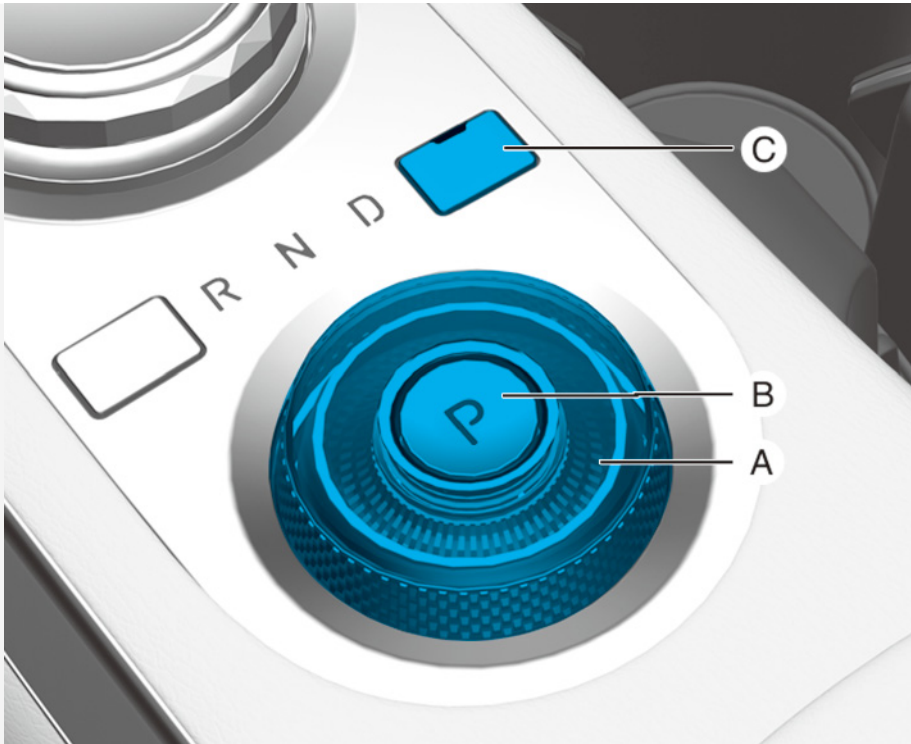

Depress the brake pedal whenever rotating the shift dial to change gear or shifting P.

OJK060002L

[A] : Rotary shifter (Rotary gear shift dial), [B] : Park button, [C] : P release cap-cover

Automatic transmission operation

The automatic transmission has eight forward speeds and one reverse speed. The individual speeds are selected automatically in the D (Drive) position.



WARNING

To reduce the risk of serious injury or death:

- **ALWAYS** check the surrounding areas near your vehicle for people, especially children, before shifting a vehicle into D (Drive) or R (Reverse).
- Before leaving the driver's seat, always make sure the vehicle is shifted to the P (Park) position, then apply the parking brake, then press the Engine Start/Stop button to the OFF position. Unexpected and sudden vehicle movement can occur if these precautions are not followed.
- When using the paddle shifter (manual shift mode), do not use engine braking (shifting from a high gear to lower gear) rapidly on slippery roads. The vehicle may slip causing an accident.

Rotary shifter/Rotary gear shift dial

P (Park)

Always come to a complete stop before shifting into P (Park).



OJK060003

To shift the gear to P (Park), press the P button while depressing the brake pedal. If you turn the engine off in R (Reverse), N (Neutral) or D (Drive), the gear will automatically shift to P (Park).



WARNING

- Shifting into P (Park) while the vehicle is in motion may cause you to lose control of the vehicle.
- After the vehicle has stopped, always make sure the vehicle is in P (Park), apply the parking brake, and turn the engine off.
- When parking on an incline, shift the gear to P (Park) and apply the parking brake to prevent the vehicle from rolling downhill.

Automatic gear shift to P (Park)

The gear is shifted to P (Park) automatically for safety reasons under the following conditions:

- When the engine is turned off with the gear in R (Reverse), D (Drive) or N (Neutral).
- When the driver's door is open with the engine running, the gear in R (Reverse), D (Drive) or N (Neutral), the seat belt unfastened and the vehicle at a standstill.
- When the driver's or front passenger's door is open with the gear in N (Neutral) and the vehicle is off.

In situations the gear must be in P (Park), always check if the gear is shifted to P (Park) by checking the cluster.

R (Reverse)

Use this position to drive the vehicle rearward.



To shift the gear to R (Rear), rotate the shift dial counterclockwise while depressing the brake pedal.

When the vehicle is stopped in the R (Reverse) position, if you open the driver's door with the seat belt unfastened, the gear will automatically shift to P (Park).

However, if the vehicle is in motion, the gear may not automatically shift to P (Park) to prevent automatic transmission damage.

NOTICE

Always come to a complete stop before shifting into or out of R (Reverse); you may damage the transmission if you shift into R (Reverse) while the vehicle is in motion.

N (Neutral)

The wheels and transmission are not engaged.



OJK060005

To shift the gear to N (Neutral), rotate the shift dial clockwise from R (Reverse) or counterclockwise from D (Drive) while depressing the brake pedal.

Always depress the brake pedal when you are shifting from N (Neutral) to another gear.

If you turn the engine off in N (Neutral), the gear will automatically shift to P (Park).

However, if you need to stay in N (Neutral) with the engine off, refer to “To stay in N (Neutral) when vehicle is OFF” in the following description.



CAUTION

The engine can be started with the gear in N (Neutral), but for your safety, be sure to start the engine with the gear in P (Park).

To stay in N (Neutral) when vehicle is OFF

■ Type A

Press and hold OK button to stay in Neutral when vehicle is Off

OJX1069009L

■ Type B

Hold OK button to stay in neutral gear position when vehicle is Off

OJX1069058L

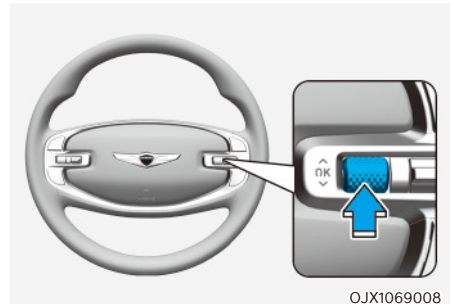

OJX1069008

If you want to stay in N (Neutral) after the engine is OFF (in the ACC state), do the following.

1. Turn off Auto Hold and release Electronic Parking Brake when the engine is running.
2. Rotate the shift dial to N (neutral) while depressing the brake pedal.
3. When you take your foot off the brake pedal, the message ‘Press and hold OK button to stay in Neutral when vehicle is Off’ (or ‘Hold OK button to stay in neutral gear position when vehicle is Off’) will appear on the cluster LCD display.

4. Press and hold the OK button on the steering wheel for more than 1 second.
5. When the message 'Vehicle will stay in (N). Change gear to cancel' (or 'N will stay engaged when the vehicle is Off') appears on the cluster LCD display, press the Engine Start/Stop button while depressing the brake pedal.

However, if you open the driver's or front passenger's door, the gear will automatically shift to P (Park) and the Engine Start/Stop button will change to the OFF position.

NOTICE

With the gear in N (Neutral) the Engine Start/Stop button will be in the ACC position. Note that the doors cannot be locked in the ACC position or the battery may discharge if left in the ACC position for a long period.

D (Drive)

This is the normal driving position.

The transmission will automatically shift through an 8-gear sequence, providing the best fuel economy and power.

For extra power when passing another vehicle or driving uphill, depress the accelerator pedal further until you feel the transmission downshift to a lower gear.



OJK060006

To shift the gear to D (Drive), rotate the shift dial clockwise while depressing the brake pedal.

When the vehicle is stopped in the D (Drive) position, if you open the driver's door with the seat belt unfastened, the gear will automatically shift to P (Park).

However, if the vehicle is in motion, the gear may not automatically shift to P (Park) to prevent automatic transmission damage.

NOTICE

Always come to a complete stop before shifting into D (Drive).



CAUTION

When you start after stopping on a steep incline, even if the gear is in D (Drive), if you do not depress the accelerator or brake pedal, the vehicle may roll backwards, which can cause an accident.

When the battery is discharged

You cannot shift gears, when the battery is discharged.

In emergencies, do the following to shift the gear to N (Neutral) on a level ground.

1. Connect the battery cables from another vehicle or from a another battery to the jump-starting terminals inside the engine compartment.

For more details, refer to "Jump Starting" section in chapter 8.

2. Release the Electronic Parking Brake with the Engine Start/Stop button in the ON position.
3. Press the Engine Start/Stop button to the OFF position.

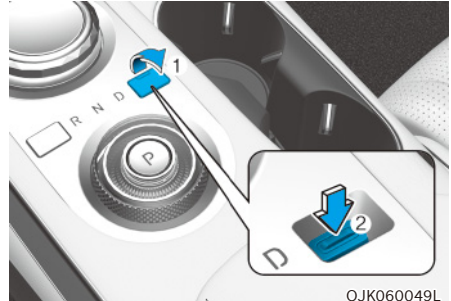

OJK060049L

4. Remove the cap-cover (1) and press the button (2) while depressing the brake pedal.

Then, the gear will change to the N (Neutral) position. The button must be pressed within 3 minutes after the engine is turned off. The button (2) operates only for 20 seconds to change the gear between P (Park) and N (Neutral) from the time when the button (2) is first pressed.

i Information

In situations when the gear needs to be shifted from P (Park) to N (Neutral) when the Engine Start/Stop button is in the OFF position, refer to step 4.

Shift-lock system

For your safety, the automatic transmission has a shift-lock system which prevents shifting the transmission from P (Park) into R (Reverse) or D (Drive) unless the brake pedal is depressed.

To shift from P (Park) or N (Neutral) into R (Reverse) or D (Drive):

1. Depress and hold the brake pedal.
2. Start the engine.
3. Shift gear while depressing the brake pedal.

Parking

Always come to a complete stop and continue to depress the brake pedal. Shift the gear to P (Park), apply the parking brake, and press the Engine Start/Stop button to the OFF position. Take the Key with you when leaving the vehicle.

WARNING

- **When you stay in the vehicle with the engine running, be careful not to depress the accelerator pedal for a long period of time. The engine or exhaust system may overheat and start a fire.**
- **The exhaust gas and the exhaust system are very hot. Keep away from the exhaust system components.**
- **Do not stop or park over flammable materials, such as dry grass, paper or leaves. They may ignite and cause a fire.**

LCD display messages (cluster)

Press brake pedal to change gear

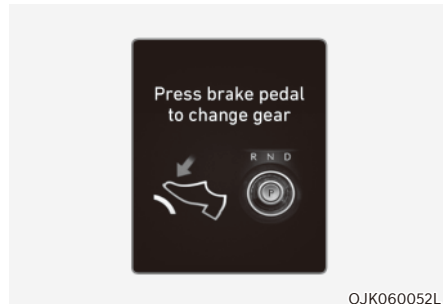

This message is displayed when the brake pedal is not depressed while shifting the gear.

Depress the brake pedal and then shift the gear.

Shift to P after stopping

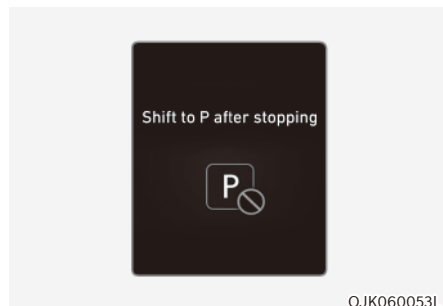

This message is displayed when the gear is shifted to P (Park) while the vehicle is moving.

Stop the vehicle before shifting to P (Park).

Shifting conditions not met

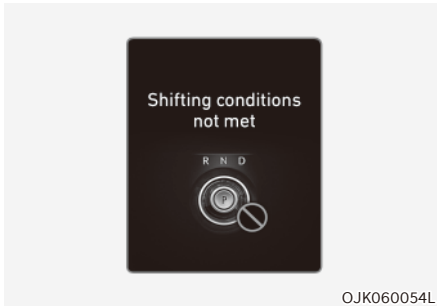

This message is displayed when engine RPM is too high, or when driving speed is too fast to shift the gear.

Decrease vehicle speed or slow down before shifting the gear.

Shifter system malfunction/Shifting system error

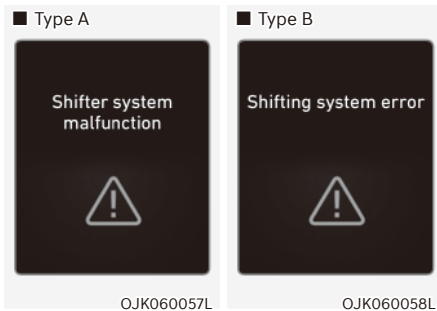

This message is displayed when the transmission or the shift button does not properly operate in the P (Park) position.

We recommend that you have the vehicle inspected by an authorized retailer of Genesis Branded products.

Check shifter dial / Check rotary gear shift dial

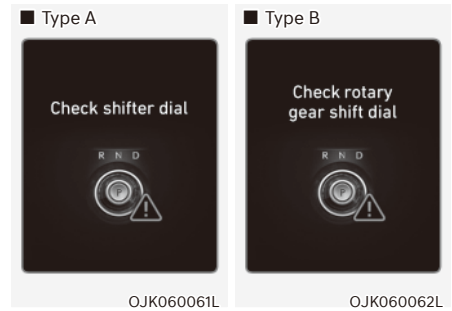

This message is displayed when there is a malfunction with the shift dial.

We recommend that you have the vehicle inspected by an authorized retailer of Genesis Branded products.

Check P button

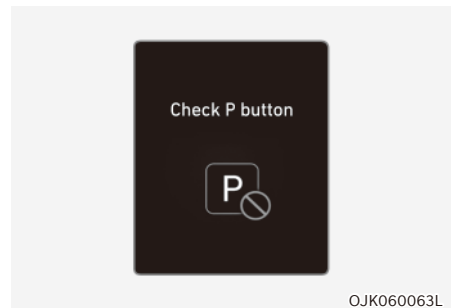

This message is displayed when there is a problem with the P button.

We recommend that you have the vehicle inspected by an authorized retailer of Genesis Branded products.

Rotary shifter stuck / Rotary gear shift dial stuck

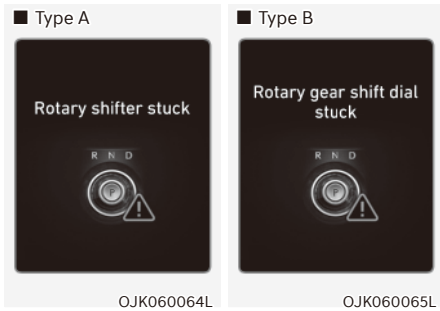

This message is displayed when the shift dial does not return back to its normal position after rotating it.

We recommend that you have the vehicle inspected by an authorized retailer of Genesis Branded products.

Vehicle Power limited due to high transmission temperature / High transmission temperature. Power limited

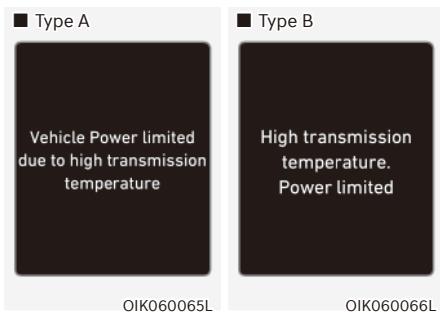

This message is displayed when the transmission oil temperature is high. Drive at steady speed or stop the vehicle at a safe place with the engine on. When the oil temperature returns to normal, the message will disappear.

Paddle shifter (Manual shift mode)

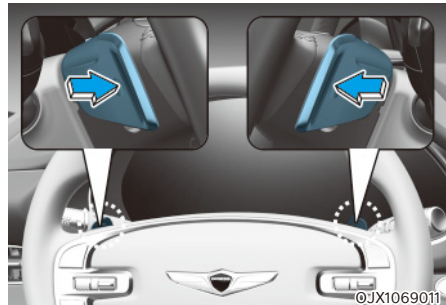

The paddle shifter allows the driver to shift gear without taking one's hands off the steering wheel.

The paddle shifter operates as follow.

- Pull the [+] or [-] paddle shifter once to shift up or down one gear and the system changes from automatic shift mode to manual shift mode.
- To change back to automatic shift mode from manual shift mode, do one of the following:
 - Pull the [+] paddle shifter for more than one second.
 - Drive the vehicle under 7 km/h (4 mph).
 - Gently depress the accelerator pedal for more than 6 seconds. However, if SPORT mode, SPORT+ mode, or CUSTOM mode (setting powertrain to SPORT or SPORT+) is selected, the paddle shifter will not change to automatic shift mode from manual shift mode.
 - Rotate the shift dial to the D (Drive) position.

 Information

If the [+] and [-] paddle shifters are pulled at the same time, gear shift may not occur.

Good driving practices

- Never shift the gear from P (Park) or N (Neutral) to any other position with the accelerator pedal depressed.
- Never shift the gear into P (Park) when the vehicle is in motion.

Be sure the vehicle is completely stopped before you attempt to shift into R (Reverse) or D (Drive).

- Do not shift the gear to N (Neutral) when driving. If the gear is shifted to N (Neutral) while driving, the vehicle loses the ability to provide engine braking. Doing so may increase the risk of an accident.

Also, shift the gear back to D (Drive) while the vehicle is moving may severely damage the transmission.

- When driving uphill or downhill, always shift to D (Drive) for driving forward or shift to R (Reverse) for driving backwards, and check the gear position indicated on the cluster before driving. Driving in the opposite direction of the selected gear, can lead to a dangerous situation by shutting off the engine and affecting the braking performance.
- Do not drive with your foot resting on the brake pedal. Even light, but consistent pedal pressure can result in the brakes overheating, brake wear and possibly even brake failure.
- Always apply the parking brake when leaving the vehicle. Do not depend on placing the transmission in P (Park) to keep the vehicle from moving.
- Exercise extreme caution when driving on a slippery surface. Be especially careful when braking, accelerating or shifting gears. On a slippery surface, an abrupt change in vehicle speed can cause the drive wheels to lose traction and may cause loss of vehicle control resulting in an accident.

- Optimum vehicle performance and economy is obtained by smoothly depressing and releasing the accelerator.



WARNING

To reduce the risk of **SERIOUS INJURY** or **DEATH**:

- **ALWAYS wear your seat belt. In a collision, an unbelted occupant is significantly more likely to be seriously injured or killed than a properly belted occupant.**
- **Avoid high speeds when cornering or turning.**
- **Do not make quick steering wheel movements, such as sharp lane changes or fast, sharp turns.**
- **The risk of rollover is greatly increased if you lose control of your vehicle at highway speeds.**
- **Loss of control often occurs if two or more wheels drop off the roadway and the driver over steers to reenter the roadway.**
- **In the event your vehicle leaves the roadway, do not steer sharply. Instead, slow down before pulling back into the travel lanes.**
- **Genesis Branded Vehicle recommends you to follow all posted speed limits.**

NOTICE

Kickdown mechanism

Use the kickdown mechanism for maximum acceleration. Depress the accelerator pedal beyond the pressure point. The automatic transmission will shift to a lower gear depending on the engine speed.

BRAKING SYSTEM

Power-assist brakes

Your vehicle has power-assisted brakes that adjust automatically through normal usage.

If the engine is not running or is turned off while driving, the power assist for the brakes will not work. You can still stop your vehicle by applying greater force to the brake pedal than typical. The stopping distance, however, will be longer than with power brakes.

When the engine is not running, the reserve brake power is partially depleted each time the brake pedal is applied. Do not pump the brake pedal when the power assist has been interrupted.



WARNING

Take the following precautions:

- **Do not drive with your foot resting on the brake pedal. This will create abnormal high brake temperatures, excessive brake lining and pad wear, and increased stopping distances.**
- **When descending down a long or steep hill, use the paddle shifter and manually downshift to a lower gear in order to control your speed without using the brake pedal excessively. Applying the brakes continuously will cause the brakes to overheat and could result in a temporary loss of braking performance.**

- **Wet brakes may impair the vehicle's ability to safely slow down; the vehicle may also pull to one side when the brakes are applied. Applying the brakes lightly will indicate whether they have been affected in this way. Always test your brakes in this fashion after driving through deep water. To dry the brakes, lightly tap the brake pedal to heat up the brakes while maintaining a safe forward speed until brake performance returns to normal. Avoid driving at high speeds until the brakes function correctly.**

Disc brakes wear indicator

When your brake pads are worn and new pads are required, you will hear a high pitched warning sound from your front or rear brakes. You may hear this sound come and go or it may occur whenever you depress the brake pedal.

Note that some driving conditions or climates may cause a brake squeal when you first apply (or lightly apply) the brakes. This is normal and does not indicate a problem with your brakes.

NOTICE

To avoid costly brake repairs, do not continue to drive with worn brake pads.



Information

Always replace brake pads as complete front or rear axle sets.

High performance brake

For vehicles equipped with the High Performance Brake (large diameter monoblock brakes with enhanced braking performance), noise such as a squeal, squeak or groan is generated while braking. This is normal and the friction may create circle patterns on the disc surface. This is also a normal condition which does not affect braking performance.



WARNING

Frequent braking may deform components and worn the disc brake causing vibration when braking. Observe the speed limit to prevent brake damage from excessive braking.

Brake wear, noise, vibration from excessive braking or deformation of the brakes caused by repeatedly braking in high speed, racing on tracks, etc. can be excluded from warranty coverage.

Electronic Parking Brake (EPB)

Applying the parking brake

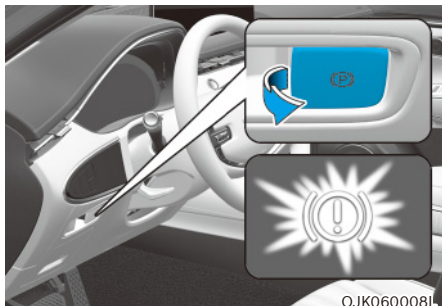

To apply EPB (Electronic Parking Brake):

1. Depress and hold the brake pedal.
2. Pull up the EPB switch.

Make sure the Parking Brake warning light comes on.

EPB (Electronic Parking Brake) may be automatically applied when:

- Requested by other systems
- The driver turns the vehicle off while Auto Hold is operating.

Emergency braking

If there is a problem with the brake pedal while driving, emergency braking is possible by pulling up and holding the EPB switch. Braking is possible only while you are holding the EPB switch. However, braking distance will be longer than normal.



WARNING

To reduce the risk of **SERIOUS INJURY** or **DEATH**, do not operate the EPB while the vehicle is moving except in an emergency situation. It could damage the brake system and lead to an accident.



Information

During emergency braking, the Parking Brake warning light will illuminate to indicate that the system is operating.

NOTICE

If you continuously notice a noise or burning smell when the EPB is used for emergency braking, we recommend that you have the system checked by an authorized retailer of Genesis Branded products.

Releasing the parking brake

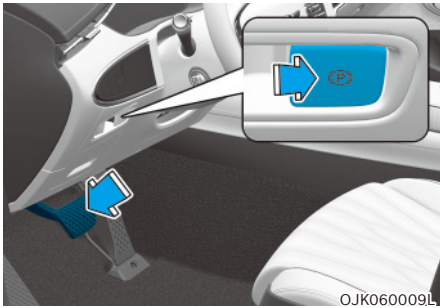

To release EPB (Electronic Parking Brake):

1. Press the Engine Start/Stop button to the ON or START position.
2. Press the EPB switch while depressing the brake pedal.

Make sure the Parking Brake warning light goes off.

To release EPB (Electronic Parking Brake) automatically:

- Gear in P (Park)
With the engine running depress the brake pedal and shift out of P (Park) to R (Reverse) or D (Drive).
- Gear in N (Neutral)
With the engine running depress the brake pedal and shift out of N (Neutral) to R (Reverse) or D (Drive).

- Satisfy the following conditions
 1. Ensure seat belts are fastened and the doors, hood and tailgate are closed.
 2. With the engine running, depress the brake pedal and shift out of P (Park) to R (Reverse), D (Drive) or Manual shift mode.
 3. Depress the accelerator pedal.
Make sure the Parking Brake warning light goes off.

i Information

- **For the Middle East, EPB is released regardless of seat belt fastening.**
- **For your safety, you can engage EPB even though the Engine Stop/Start button is in the OFF position (only if battery power is available), but you cannot release it.**
- **For your safety, depress the brake pedal and release the parking brake manually with the EPB switch when you drive downhill or when backing up the vehicle.**

NOTICE

- **If the Parking Brake warning light is still on even though the EPB has been released, we recommend that you have the system checked by an authorized retailer of Genesis Branded products.**
- **Do not drive your vehicle with EPB applied. It may cause excessive brake pad and brake rotor wear.**

Warning messages

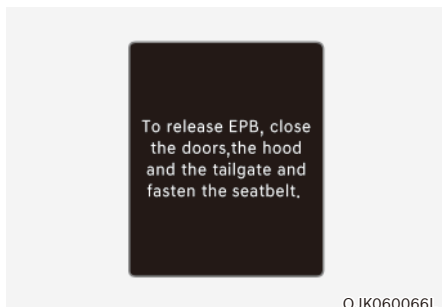

To release EPB, close the doors, hood and tailgate and fasten the seatbelt

- If you try to drive with EPB applied, a warning will sound and a message will appear.
- If the driver's seat belt is unfastened and the engine hood or tailgate is opened, a warning will sound and a message will appear.
- If there is a problem with the vehicle, a warning may sound and a message may appear.

If the situation occurs, depress the brake pedal and release EPB by pressing the EPB switch.



WARNING

- **Whenever leaving the vehicle or parking, always come to a complete stop and continue to depress the brake pedal.**

Shift the gear into P (Park), pull the EPB switch, and press the Engine Start/Stop button to the OFF position. Take the Key with you when leaving the vehicle.

Vehicles not fully engaged in P (Park) with the parking brake set are at risk for moving inadvertently and causing injury to yourself or others.

- **NEVER** allow anyone who is unfamiliar with the vehicle to touch the EPB switch. If EPB is released unintentionally, serious injury may occur.
- **Only** release EPB when you are seated inside the vehicle with your foot firmly on the brake pedal.

NOTICE

- **Do not** apply the accelerator pedal while the parking brake is engaged. If you depress the accelerator pedal with EPB engaged, a warning will sound and a message will appear. Damage to the parking brake may occur.
- **Driving** with the parking brake on can overheat the braking system and cause premature wear or damage to brake parts. **Make sure** EPB is released and the Parking Brake warning light is off before driving.



Information

- **A clicking sound may be heard while operating or releasing the EPB. These conditions are normal and indicate that EPB is functioning properly.**
- **When leaving your keys with a parking attendant or assistant, make sure to inform him/her how to operate EPB.**

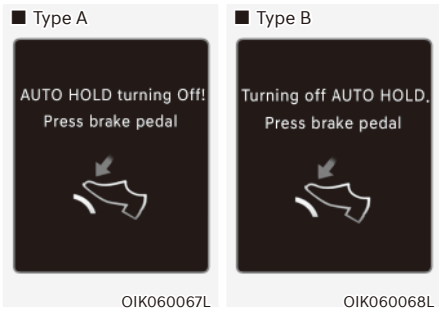

AUTO HOLD turning Off! Press brake pedal /Turning off AUTO HOLD. Press brake pedal

When the conversion from Auto Hold to EPB is not working properly a warning will sound and a message will appear.

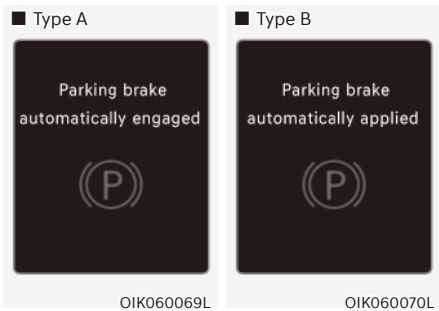

Parking brake automatically engaged / Parking brake automatically applied

When EPB is applied while Auto Hold is activated, a warning will sound and a message will appear.

EPB malfunction

Electronic Parking Brake (EPB) warning light illuminates if the Engine Start/Stop button is pressed to the ON position and goes off in approximately 3 seconds if the system is operating normally.

If the EPB warning light remains on, comes on while driving, or does not come on when the Engine Start/Stop button is pressed to the ON position, this indicates that the EPB may have malfunctioned.

If this occurs, we recommend that you have the system checked by an authorized retailer of Genesis Branded products.

The EPB warning light may illuminate when the ESC indicator comes on to indicate that ESC is not working properly, but it does not indicate a malfunction of EPB.

NOTICE

- If the EPB warning light is still on, we recommend that you have the system checked by an authorized retailer of Genesis Branded products.
- If the Parking Brake warning light does not illuminate or blinks even though the EPB switch was pulled up, EPB may not be applied.
- If the Parking Brake warning light blinks when the EPB warning light is on, press the switch, and then pull it up. Repeat this one more time. If the EPB warning does not go off, we recommend that you have the system checked by an authorized retailer of Genesis Branded products.

Parking brake warning light

Check the Parking Brake warning light by pressing the Engine Stop/Start button to the ON position.

This light will be illuminated when the parking brake is applied with the Engine Stop/Start button in the START or ON position.

Before driving, be sure the parking brake is released and the Parking Brake warning light is OFF.

If the Parking Brake warning light remains on after the parking brake is released while the engine is running, there may be a malfunction in the brake system. Immediate attention is necessary.

If at all possible, cease driving the vehicle immediately. If that is not possible, use extreme caution while operating the vehicle and only continue to drive the vehicle until you can reach a safe location.

When the EPB (Electronic Parking Brake) does not release

If the EPB does not release normally, we recommend that you contact an authorized retailer of Genesis Branded products by loading the vehicle on a flatbed tow truck and have the system checked.

Auto Hold

Auto Hold maintains the vehicle in a standstill even though the brake pedal is not depressed after the driver brings the vehicle to a complete stop by depressing the brake pedal.

To apply:

OJK060010

1. With the driver's door and engine hood closed, depress the brake pedal and then press the AUTO HOLD switch. The white AUTO HOLD indicator will come on and the system will be in the standby position.

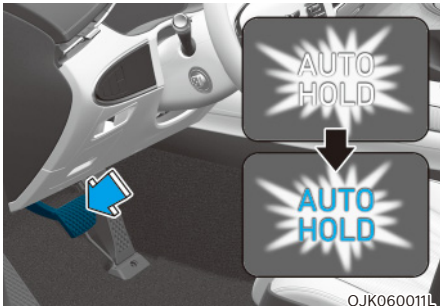

2. When you stop the vehicle completely by depressing the brake pedal, Auto Hold maintains the brake pressure to hold the vehicle stationary. The indicator changes from white to green.
3. The vehicle will remain stationary even if you release the brake pedal.
4. If EPB is applied, Auto Hold will be released.

To release:

If you depress the accelerator pedal with the gear in D (Drive), R (Reverse) or Manual shift mode, the Auto Hold will be released automatically and the vehicle will start to move. The AUTO HOLD indicator changes from green to white.



WARNING

When Auto Hold is automatically released by depressing the accelerator pedal, always take a look around your vehicle.

Slowly depress the accelerator pedal for a smooth start.

To cancel:



1. Depress and hold the brake pedal.
2. Press the AUTO HOLD switch. The AUTO HOLD indicator will turn off.



WARNING

To prevent, unexpected and sudden vehicle movement, ALWAYS press your foot on the brake pedal to cancel the Auto Hold before you:

- Drive downhill.
- Drive the vehicle in R (Reverse).
- Park the vehicle.

i Information

- The Auto Hold does not operate when:
 - The driver's door is opened
 - The engine hood is opened
 - The gear is in P (Park)
 - EPB is applied
- For your safety, the Auto Hold automatically switches to EPB when:
 - The driver's door is opened
 - The engine hood is opened
 - The vehicle is in a standstill for more than 10 minutes
 - The vehicle is standing on a steep slope
 - The vehicle moved several times

In these cases, the Parking Brake warning light comes on, the AUTO HOLD indicator changes from green to white, and a warning sound and a message will appear to inform you that EPB has been automatically engaged. Before driving off again, depress the brake pedal, check the surrounding area near your vehicle and release the parking brake manually with the EPB switch.

- While operating Auto Hold, you may hear mechanical noise. However, it is normal operating noise.

NOTICE

If the AUTO HOLD indicator changes to yellow, Auto Hold is not working properly. We recommend that you contact an authorized retailer of Genesis Branded products.

WARNING

- Depress the accelerator pedal slowly when you start the vehicle.
- For your safety, cancel Auto Hold when you drive downhill, back up the vehicle or park the vehicle.

NOTICE

If there is a malfunction with the driver's door or engine hood open detection system, Auto Hold may not work properly.

We recommend that you contact an authorized retailer of Genesis Branded products.

Warning messages

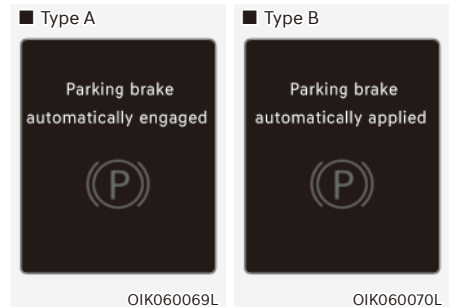

Parking brake automatically engaged / Parking brake automatically applied

When EPB is applied while Auto Hold is activated, a warning will sound and a message will appear.

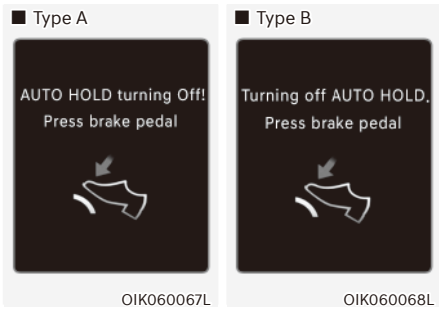

AUTO HOLD turning Off! Press brake pedal / Turning off AUTO HOLD. Press brake pedal

When the conversion from Auto Hold to EPB is not working properly a warning will sound and a message will appear.

When this message is displayed, Auto Hold and EPB may not operate. For your safety, depress the brake pedal.

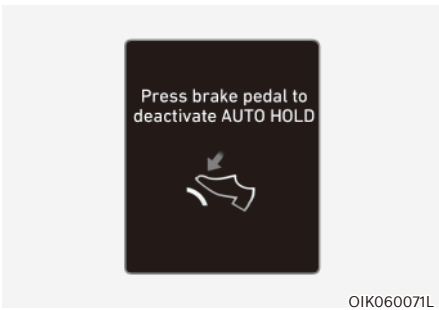

Press brake pedal to deactivate AUTO HOLD

If you did not apply the brake pedal when you release Auto Hold by pressing the AUTO HOLD switch, a warning will sound and a message will appear.

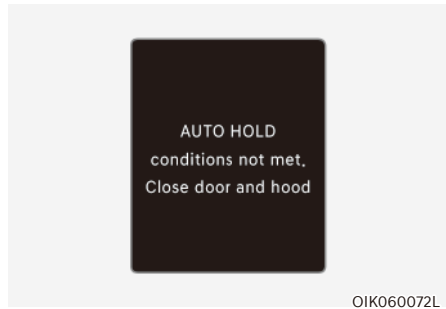

AUTO HOLD conditions not met. Close door and hood.

When you press the AUTO HOLD switch, if the driver's door and engine hood are not closed, a warning will sound and a message will appear on the cluster LCD display.

Press the AUTO HOLD switch after closing the driver's door and hood.

Anti-lock Brake System (ABS)



WARNING

Anti-Lock Braking System (ABS) or Electronic Stability Control (ESC) system will not prevent accidents due to improper or dangerous driving maneuvers. Even though vehicle control is improved during emergency braking, always maintain a safe distance between you and objects ahead of you. Vehicle speeds should always be reduced during extreme road conditions. The braking distance for vehicles equipped with ABS or ESC may be longer than for those without these systems in the following road conditions.

Drive your vehicle at reduced speeds during the following conditions:

- **Rough, gravel or snow-covered roads.**
- **On roads where the road surface is pitted or has different surface height.**
- **Tire chains are installed on your vehicle.**

The safety features of ABS or ESC equipped vehicle should not be tested by high speed driving or cornering. This could endanger the safety of yourself or others.

ABS is an electronic braking system that helps prevent a braking skid. ABS allows the driver to steer and brake at the same time.

Using ABS

To obtain the maximum benefit from your ABS in an emergency situation, do not attempt to modulate your brake pressure and do not try to pump your brakes. Depress your brake pedal as hard as possible.

When you apply your brakes under conditions which may lock the wheels, you may hear sounds from the brakes, or feel a corresponding sensation in the brake pedal. This is normal and it means your ABS is active.

ABS does not reduce the time or distance it takes to stop the vehicle.

Always maintain a safe distance from the vehicle in front of you.

ABS will not prevent a skid that results from sudden changes in direction, such as trying to take a corner too fast or making a sudden lane change. Always drive at a safe speed for the road and weather conditions.

ABS cannot prevent a loss of stability. Always steer moderately when braking hard. Severe or sharp steering wheel movement can still cause your vehicle to veer into oncoming traffic or off the road.

On loose or uneven road surfaces, operation of the anti-lock brake system may result in a longer stopping distance than for vehicles equipped with a conventional brake system.

The ABS ((ABS)) warning light will stay on for several seconds after the Engine Start/Stop button is in the ON position.

During that time, ABS will go through self-diagnosis and the light will go off if everything is normal. If the light stays on, you may have a problem with your ABS. We recommend that you contact an authorized retailer of Genesis Branded products as soon as possible.



WARNING

If the ABS ((ABS)) warning light is on and stays on, you may have a problem with the ABS. Your power brakes will work normally. To reduce the risk of serious injury or death, we recommend that you contact your authorized retailer of Genesis Branded products as soon as possible.

NOTICE

When you drive on a road having poor traction, such as an icy road, and apply your brakes continuously, ABS will be active continuously and the ABS ((ABS)) warning light may illuminate. Pull your vehicle over to a safe place and turn the vehicle off.

Restart the vehicle. If the ABS warning light is off, then your ABS system is normal.

Otherwise, you may have a problem with your ABS system. We recommend that you contact an authorized retailer of Genesis Branded products as soon as possible.



Information

When you jump start your vehicle because of a drained battery, the ABS ((ABS)) warning light may turn on at the same time. This happens because of the low battery voltage. It does not mean your ABS is malfunctioning. Have the battery recharged before driving the vehicle.

Electronic Stability Control (ESC)

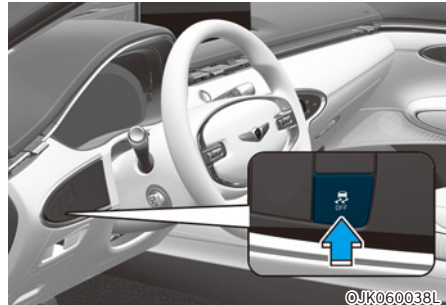

Electronic Stability Control helps to stabilize the vehicle during cornering maneuvers.

ESC checks where you are steering and where the vehicle is actually going. ESC applies braking pressure to any one of the vehicle's brakes and intervenes in the engine management system to assist the driver with keeping the vehicle on the intended path. It is not a substitute for safe driving practices. Always adjust your speed and driving to the road conditions.



WARNING

Never drive too fast for the road conditions when cornering. ESC will not prevent accidents.

Excessive speed in turns, abrupt maneuvers, and hydroplaning on wet surfaces can result in severe accidents.

ESC operation

ESC ON condition

When the Engine Start/Stop button is in the ON position, ESC and the ESC OFF indicator lights illuminate for approximately three seconds. After both lights go off, ESC is enabled.

When operating



When ESC is in operation, the ESC indicator light blinks:

- When you apply your brakes under conditions which may lock the wheels, you may hear sounds from the brakes, or feel a corresponding sensation in the brake pedal. This is normal and it means your ESC is active.
- When ESC activates, the engine may not respond to the accelerator as it does under routine conditions.

- When moving out of the mud or driving on a slippery road, the engine RPM (revolutions per minute) may not increase even if you press the accelerator pedal deeply. This is to maintain the stability and traction of the vehicle and does not indicate a problem.

ESC OFF condition



To cancel ESC operation:

- **State 1**
Press the ESC OFF button briefly. The ESC OFF indicator light and/or message 'Traction Control disabled' will illuminate. In this state, the traction control function of ESC (engine management) is disabled, but the brake control function of ESC (braking management) still operates. ESC OFF state 1 will be automatically set and the ESC OFF indicator light and/or message will illuminate on the cluster when SPORT+ mode is selected for Drive mode.
- **State 2**
Press and hold the ESC OFF button continuously for more than 3 seconds. The ESC OFF indicator light and/or message 'Traction & Stability Control disabled' illuminates and a warning chime sounds. In this state, both the traction control function of ESC (engine management) and the brake control function of ESC (braking management) are disabled.
If the Engine Start/Stop button is pressed to the OFF position when ESC is off, ESC remains off. Upon restarting the vehicle, ESC will automatically turn on again.

Indicator lights

- ESC indicator light (blinks)



- ESC OFF indicator light (comes on)



When the Engine Start/Stop button is pressed to the ON position, the ESC indicator light illuminates, then goes off if the ESC system is operating normally.

The ESC indicator light blinks whenever ESC is operating.

If the ESC indicator light stays on, your vehicle may have a malfunction with the ESC system. When this warning light illuminates we recommend that the vehicle be checked by an authorized retailer of Genesis Branded products as soon as possible.

The ESC OFF indicator light comes on when ESC is turned off.



WARNING

When ESC is blinking, this indicates ESC is active:

Drive slowly and NEVER attempt to accelerate. NEVER turn ESC off while the ESC indicator light is blinking or you may lose control of the vehicle resulting in an accident.

NOTICE

Driving with wheels and tires with different sizes may cause the ESC system to malfunction. Before replacing tires, make sure all four tires and wheels are the same size. Never drive the vehicle with different sized wheels and tires installed.

ESC OFF usage

When Driving

The ESC OFF mode should only be used briefly to help free the vehicle if stuck in snow or mud, by temporarily stopping operation of ESC, to maintain wheel torque.

To turn ESC off while driving, press the ESC OFF button while driving on a flat road surface.

NOTICE

To prevent damage to the transmission:

- **Do not allow wheel(s) of one axle to spin excessively while the ESC, ABS, and Parking Brake warning lights are displayed. The repairs would not be covered by the vehicle warranty. Reduce engine power and do not spin the wheel(s) excessively while these lights are displayed.**
- **When operating the vehicle on a dynamometer, make sure ESC is turned off (ESC OFF light illuminated).**



Information

Turning ESC off does not affect ABS or standard brake system operation.

Vehicle Stability Management (VSM)

Vehicle Stability Management is a function of the Electronic Stability Control (ESC) system. It helps the vehicle stay stable when accelerating or braking suddenly on wet, slippery and rough roads where traction over the four tires can suddenly become uneven.



WARNING

Take the following precautions when using Vehicle Stability Management:

- **ALWAYS** check the speed and the distance to the vehicle ahead. VSM is not a substitute for safe driving practices.
- **Never** drive too fast for the road conditions. VSM will not prevent accidents. Excessive speed in bad weather, on slippery and uneven roads can result in severe accidents.

VSM operation

When operating

When you apply your brakes under conditions which may activate ESC, you may hear sounds from the brakes, or feel a corresponding sensation in the brake pedal. This is normal and it means your VSM is active.



Information

VSM does not operate when:

- Driving on a banked road such as gradient or incline.
- Driving in reverse.
- The ESC OFF indicator light is on.
- The EPS (Electric power steering) warning light (⚠) is on or blinks.

VSM OFF condition

To cancel VSM operation, press the ESC OFF button. ESC OFF (OFF) indicator light will illuminate.

To turn on VSM, press the ESC OFF button again. The ESC OFF indicator light will go out.



WARNING

If the ESC (ESP) indicator light or EPS (EPS) warning light stays illuminated or blinks, your vehicle may have a malfunction with the VSM system. When the warning light illuminates we recommend that the vehicle be checked by an authorized retailer of Genesis Branded products as soon as possible.

NOTICE

Driving with wheels and tires with different sizes may cause the VSM system to malfunction. Before replacing tires, make sure all four tires and wheels are the same size. Never drive the vehicle with different sized tires and wheels installed.

Hill-Start Assist Control (HAC)

Hill-Start Assist Control helps prevent the vehicle from rolling backwards when starting a vehicle from a stop on a hill. The system operates the brakes automatically for approximately 2 seconds (maximum of 5 seconds when the accelerator pedal is slightly depressed during HAC operation) and releases the brake after 2 seconds or when the accelerator pedal is depressed.



WARNING

Always be ready to depress the accelerator pedal when starting off an incline. Hill-Start Assist Control activates only for approximately 2 seconds (maximum of 5 seconds when the accelerator pedal is slightly depressed during HAC operation).



Information

- Hill-Start Assist Control does not operate when the gear is shifted to P (Park) or N (Neutral).
- Hill-Start Assist Control activates even when the ESC (Electronic Stability Control) is off. However, it does not activate, when ESC does not operate normally.

Emergency Stop Signal (ESS) (if equipped)

Emergency Stop Signal alerts the driver behind by blinking the stop lights, while sharply and severely braking.

The system is activated when:

- The vehicle suddenly stops. (The deceleration power exceeds 7 m/s^2 , and the driving speed exceeds 55 km/h (34 mph .)
- ABS is activated and the driving speed exceeds 55 km/h (34 mph).

The hazard warning flasher automatically turns ON after blinking the stop lights:

- When driving speed is under 40 km/h (25 mph),
- When ABS is deactivated, and
- When the sudden braking situation is over.

The hazard warning flasher turns OFF:

- When the vehicle drives at a low speed for a certain period of time.

The driver can manually turn OFF the hazard warning flasher by pressing the button.



Information

Emergency Stop Signal will not activate, when the hazard warning flashers are already on.

Multi-Collision Brake (MCB) (if equipped)

Multi-Collision Brake controls the brake automatically in the event of an accident where the air bag deploys or pre-tensioner seat belt activates to reduce the risk of additional accidents that may occur.

System operation

- From the time the air bag deploys or pre-tensioner seat belt activates, Multi-Collision Brake monitors the depression intensity of the brake pedal and accelerator pedal for a short period. The system operates when the following conditions are met:
 - Vehicle speed is under 180 km/h (112 mph) at the time of collision.
 - The brake pedal and accelerator pedal is hardly depressed.
- When the driver steps on the brake pedal over a certain level while Multi-Collision Brake is active, the braking power takes priority over automatic braking by Multi-Collision Brake system. However, if the driver takes his/her foot off the brake pedal, automatic braking by Multi-Collision Brake system will maintain automatic braking.

System off

Multi-Collision Brake is canceled in the following situations:

- The accelerator pedal is depressed over a certain level.
- The vehicle stops.
- ESC (Electronic Stability Control) or electronic devices has malfunctioned.
- In a situation system cannot operate normally.
- Ten seconds have passed since the brake has been controlled automatically by Multi-Collision Brake system.



WARNING

- **Multi-Collision Brake decreases vehicle speed after a collision, but it does not prevent a second collision. You may drive away from the collision spot to avoid other dangerous situations by depressing the accelerator pedal.**
- **After the vehicle is stopped by Multi-Collision Brake, the system stops controlling the brakes. Depending on the situation, the driver should depress the brake or the accelerator pedal to prevent further accidents.**

Downhill Brake Control (DBC)







Downhill Brake Control assists the driver to descend down a steep hill without having to depress the brake pedal.

The system automatically applies the brakes to maintain vehicle speed below a certain speed and allows the driver to concentrate on steering the vehicle down hill.

The system is turned off whenever the engine is turned off.

Press the button to turn on the system and press the button again to turn it off.

System operation

Mode	Indicator	Description
Standby	 Green light on	Press the Downhill Brake Control button when vehicle speed is under 60 km/h (37 mph). Downhill Brake Control will turn on and enter the standby mode. The system does not turn on if vehicle speed is over 60 km/h (37 mph).
Activated	 Green light blink	<p>In the standby mode, Downhill Brake Control will activate under the following conditions:</p> <ul style="list-style-type: none"> • The hill is steep enough. • The brake pedal or accelerator pedal is not depressed. • MUD mode is selected from All Wheel Drive (AWD) multi terrain mode and vehicle speed is within 4-40km/h (2-25 mph) range (within 4-8 km/h (2-5 mph) when reversing). <p>Within the activation speed range 4-40km/h (2-25 mph), the driver can control the vehicle speed by depressing the brake pedal or accelerator pedal.</p>
Deactivated	 Green light off	<p>Downhill Brake Control will turn off under the following conditions:</p> <ul style="list-style-type: none"> • The Downhill Brake Control button is pressed again. • Vehicle speed is over 60 km/h (37 mph).
	 Green light on	<p>Downhill Brake Control will be deactivated but maintain the standby mode under the following conditions:</p> <ul style="list-style-type: none"> • The hill is not steep enough. • Vehicle speed is between 30-60 km/h (18-37 mph).
System malfunction	 Yellow light on	The yellow warning light illuminates when the system may have malfunctioned or may not work properly during activation. If this occurs, Downhill Brake Control is deactivated. We recommend that the system be inspected by an authorized retailer of Genesis Branded products as soon as possible.

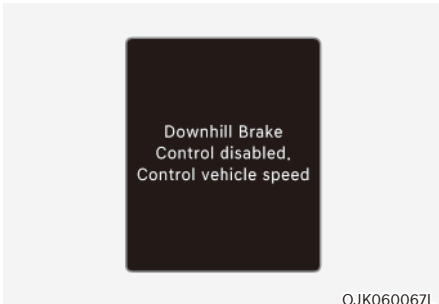

Downhill Brake Control disabled. Control vehicle speed (manually)

When Downhill Brake Control is not working properly this warning message will appear on the cluster LCD display and you will hear a warning sound. If this occurs, control vehicle speed by depressing the brake pedal.

 **WARNING**

Always turn off Downhill Brake Control on normal roads. The system might activate inadvertently from the standby mode when driving through speed bumps or making sharp curves.

 **Information**

- Downhill Brake Control may not deactivate on steep inclines even though the brake pedal or accelerator pedal is depressed.
- Downhill Brake Control may not always maintain vehicle speed at a certain speed.
- Downhill Brake Control does not operate when:
 - The gear is in P (Park).
 - ESC is activated.
- Noise or vibration may occur from the brakes when Downhill Brake Control is activated.
- The rear stop light comes on when Downhill Brake Control is activated.

Good braking practices



WARNING

Whenever leaving the vehicle or parking, always come to a complete stop and continue to depress the brake pedal. Shift the gear to the P (Park) position, then apply the parking brake, and press the Engine Start/Stop button to the OFF position.

Vehicles parked with the parking brake not applied or not fully engaged may roll inadvertently and may cause injury to the driver and others. ALWAYS apply the parking brake before exiting the vehicle.

Wet brakes can be dangerous! The brakes may get wet if the vehicle is driven through standing water or if it is washed. Your vehicle will not stop as quickly if the brakes are wet. Wet brakes may cause the vehicle to pull to one side.

To dry the brakes, apply the brakes lightly until the braking action returns to normal. If the braking action does not return to normal, stop as soon as it is safe to do so and we recommend that you call an authorized retailer of Genesis Branded products for assistance.

DO NOT drive with your foot resting on the brake pedal. Even light, but constant pedal pressure can result in the brakes overheating, brake wear, and possibly even brake failure.

If a tire goes flat while you are driving, apply the brakes gently and keep the vehicle pointed straight ahead while you slow down. When you are moving slowly enough for it to be safe to do so, pull off the road and stop in a safe location.

Keep your foot firmly on the brake pedal when the vehicle is stopped to prevent the vehicle from rolling forward.

ALL WHEEL DRIVE (AWD) (IF EQUIPPED)

All Wheel Drive (AWD) delivers engine power to front and rear wheels for maximum traction. AWD is useful when extra traction is required, such as when driving on, muddy, wet, or snow-covered roads.



WARNING

To reduce the risk of **SERIOUS INJURY** or **DEATH**:

- Avoid high speeds when cornering or turning.
- Do not make quick steering wheel movements, such as sharp lane changes or fast, sharp turns.
- The risk of a rollover is greatly increased if you lose control of your vehicle at highway speeds.
- Loss of control often occurs if two or more wheels drop off the roadway and the driver over steers to reenter the roadway.
- In the event your vehicle leaves the roadway, do not steer sharply. Instead, slow down before pulling back into the travel lanes.

NOTICE

- Do not drive in water if the level is higher than the bottom of the vehicle.
- Check your brake condition once you are out of mud or water. Depress the brake pedal several times as you move slowly until you feel normal braking return.

- Shorten your scheduled maintenance interval if you drive in off-road conditions such as sand, mud or water (see "Maintenance Under Severe Usage Conditions" section in chapter 9).
- Always wash your vehicle thoroughly after off road use, especially the bottom of the vehicle.
- Be sure to equip all four tires with the correct size and type.
- Make sure that a full time AWD vehicle is towed by a flat bed tow truck.

All Wheel Drive (AWD) operation *Auto AWD mode (Normal driving)*

If the AWD system determines there is a need for four wheel drive, the engine's driving power is distributed to all four wheels automatically.

Multi terrain mode

In the multi terrain mode, four-wheel drive, engine, transmission, braking and Electronic Limited Slip Differential (if equipped) is controlled to achieve optimal driving performance depending on the mode selected (SNOW/MUD/SAND).



Information

When switching to multi terrain mode while using SPORT+ mode, turn on ESC by briefly pressing the ESC OFF button. If SPORT+ is selected for Drive mode, ESC OFF state 1 is automatically set. Using multi terrain mode with ESC off may reduce multi terrain mode performance.

All Wheel Drive (AWD) selection

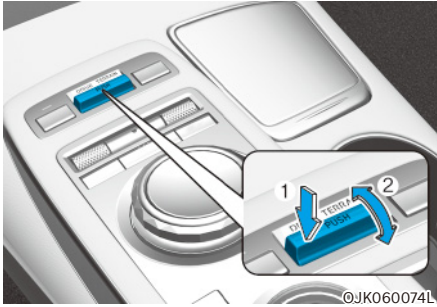

Push (1) the DRIVE/TERRAIN switch to change from normal driving mode to multi terrain mode. Push the switch up or down (2) within 4 seconds to select SNOW, MUD or SAND.

Selected mode		Description
Auto AWD (Normal driving)	-	<ul style="list-style-type: none"> Use this mode when driving on normal roads. Under normal operating conditions, the vehicle operates similar to conventional 2WD vehicles. If the system determines there is a need for four wheel drive, the engine's driving power is distributed to all four wheels automatically.
SNOW		<ul style="list-style-type: none"> Use this mode when driving on slippery roads. The engine's driving power is properly distributed to the wheels, to help start the vehicle stably on slippery roads or keep tires from slipping.
MUD		<ul style="list-style-type: none"> Use this mode when driving on muddy, unpaved or uneven roads The engine's driving power is properly distributed to the wheels, to secure sufficient driving force that will help start the vehicle.
SAND		<ul style="list-style-type: none"> Use this mode when driving on smooth, dry sand or deep gravel and unpaved roads. The engine's driving power is properly distributed to the wheels, to help drive safely on smooth, dry sand or deep gravel and unpaved roads.

Be sure to maintain Auto AWD mode when driving on normal roads. If you drive with the Multi Terrain mode on normal roads or curved roads, it may damage AWD parts and cause vibration and noise. However, vibration and noise are normal conditions that will disappear when Auto AWD mode is selected. Also, when switching between Multi Terrain mode (SNOW, MUD or SAND) and Auto AWD, a sensation may be felt as driving power is delivered to the rear wheels.



WARNING

If the AWD warning light stays on the instrument cluster, your vehicle may have a malfunction with the AWD system. Whenever the AWD warning light illuminates we recommend that the vehicle be inspected by an authorized retailer of Genesis Branded products as soon as possible.

For safe AWD operation

Before driving

- Make sure all passengers are wearing seat belts.
- Sit upright and closer to the steering wheel than usual. Adjust the steering wheel to a position comfortable for you to drive.

Driving on snow-covered or icy roads

- Start off slowly by applying the accelerator pedal gently.
- Use snow tires or tire chains.
- Keep sufficient distance between your vehicle and the vehicle in front of you.
- Apply engine braking during deceleration by using the paddle shifter (manual shift mode) and manually selecting a lower gear.
- Avoid speeding, rapid acceleration, sudden brake applications, and sharp turns to prevent skids.

Information

When using Snow Tires, mount them on all four wheels.

When using tire chains, install them on the rear tires.

However, driving speed must be below 30 km/h and minimize the driving distance. High-speed or long-term driving with tire chains installed may malfunction or damage the AWD system.

For more details on Snow Tires and Tire Chains, refer to "Winter Driving" section later in this chapter.

Driving in sand or mud

- Maintain slow and constant speed.
- Use tire chains driving in mud if necessary.
- Keep sufficient distance between your vehicle and the vehicle in front of you.

- Reduce vehicle speed and always check the road condition.
- Avoid speeding, rapid acceleration, sudden brake applications, and sharp turns to prevent getting stuck.

NOTICE

When the vehicle is stuck in snow, sand or mud, place a nonslip material under the drive wheels to provide traction OR slowly spin the wheels in forward and reverse directions which causes a rocking motion that may free the vehicle.

However, avoid running the engine continuously at high RPM, doing so may damage the AWD system.

Driving up or down hills

- Driving uphill
 - Before starting off, check if it is possible to drive uphill.
 - Drive as straight as possible.
- Driving downhill
 - Do not change gear while driving downhill. Select gear before driving downhill.
 - Drive slowly using engine braking while driving downhill.
 - Drive straight as possible.

WARNING

Exercise extreme caution driving up or down steep hills. The vehicle may flip over depending on the grade, terrain, water and mud conditions.

**WARNING**

Do not drive across the contour of steep hills. A slight change in the wheel angle can destabilize the vehicle, or a stable vehicle may lose stability if the vehicle stops its forward motion. Your vehicle may roll over and lead to a serious injury or death.

Driving through water

- Try to avoid driving in deep standing water. It may stall your engine and clog your exhaust pipes.
- If you need to drive in water, stop your vehicle, set the vehicle in Multi Terrain mode and drive under 8 km/h (5 mph).
- Do not change gear while driving in water.

**CAUTION**

Always drive slowly in water. If you drive too fast, water may get into the engine compartment and wet the ignition system causing your vehicle to suddenly stop.

Additional driving conditions

- Become familiar with the off-road conditions before driving.
- Always pay attention when driving off-road and avoid dangerous areas.
- Drive slowly when driving in heavy wind.
- Reduce vehicle speed when cornering. The center of gravity of AWD vehicles is higher than conventional 2WD vehicles, making them more likely to roll over when you rapidly turn corners.
- Always hold the steering wheel firmly when you are driving off-road.

**WARNING**

Do not grab the inside of the steering wheel when you are driving off-road. You may hurt your arm by a sudden steering maneuver or from steering wheel rebound due to an impact with objects on the ground. You could lose control of the steering wheel which may lead to serious injury or death.

Emergency precautions**Tires**

When replacing tires, be sure to equip all four tires with the same size, type, tread patterns, brand and load-carrying capacity.

**WARNING**

Do not use tire and wheel with different size and type from the one originally installed on your vehicle. It can affect the safety and performance of your vehicle, which could lead to steering failure or rollover causing serious injury.

In an emergency situation, a compact spare tire (if equipped) or Tire Mobility Kit (if equipped) may be used. But, do not use the compact spare tire continuously. Repair or replace the original tire as soon as possible to avoid failure of the differential or AWD system.

 **WARNING**

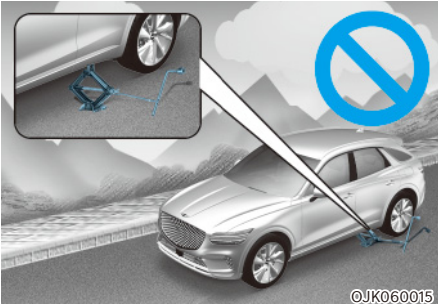

Never start or run the engine while an AWD vehicle is raised on a jack. The vehicle can slip or roll off of a jack causing serious injury or death to you or those nearby.

Towing

AWD vehicles must be towed with a wheel lift and dollies or flatbed equipment with all the wheels off the ground. **For more details, refer to "Towing" section in chapter 8.**

Vehicle inspection

- If the vehicle needs to be operated on a vehicle lift do not attempt to stop any of the four wheels from turning. This could damage the AWD system.
- Never engage the parking brake while running the engine on a car lift. This may damage the AWD system.

Dynamometer testing

An AWD vehicle must be tested on a special four wheel chassis dynamometer.

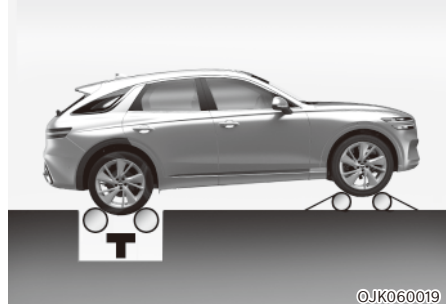

[A] : Roll tester (Speedometer),
[B] : Temporary free roller

An AWD vehicle should not be tested on a 2WD roll tester. If a 2WD roll tester must be used, perform the following procedure:

1. Check the tire pressures recommended for your vehicle.
2. Place the rear wheels on the roll tester for a speedometer test as shown in the illustration.
3. Release the parking brake.
4. Place the front wheels on the temporary free roller as shown in the illustration.

 **WARNING**

Keep away from the front of the vehicle while the vehicle is in gear on the dynamometer. The vehicle can jump forward and cause serious injury or death.

ELECTRONIC LIMITED SLIP DIFFERENTIAL (IF EQUIPPED)

Electronic Limited Slip Differential controls the differential functions of the wheels to help:

- Improve steering performance when circling at high speed.
- Improve launching performance.
- Prevent slipping on rainy or snowy roads due to dissimilar friction of the left and right wheels.



WARNING

Never run the wheels with one of wheels lifted on a jack. It is extremely dangerous for a vehicle equipped with Electronic Limited Slip Differential.

Drive mode selection

The characteristic of Electronic Limited Slip Differential varies according to which drive mode is selected by using the DRIVE MODE or DRIVE/TERRAIN switch.

Selected mode		Characteristic of e-LSD
DRIVE	ECO	COMFORT
	COMFORT	COMFORT
	SPORT	SPORT
	SPORT+	SPORT
TERRAIN	SNOW	SNOW
	MUD	MUD
	SAND	SAND

For more details, refer to "Drive Mode Integrated Control System" section in this chapter.

Warning messages

Electronic Limited Slip Differential temporarily disabled due to overheating

Overheating of related parts will temporarily disable Electronic Limited Slip Differential. Wait until the vehicle cools down.

Limited-slip differential disabled. Tire diameter mismatch / Tyre size mismatch. Limited-slip differential disabled. Check tyre sizes

If your vehicle is equipped with different tires (size, type, etc.), the message will appear. To use Electronic Limited Slip Differential, equip the vehicle with the same tires.

Check Limited Slip Differential

When Electronic Limited Slip Differential is not working properly, this warning message will appear on the cluster LCD display. If this occurs, we recommend that the system be inspected by an authorized retailer of Genesis Branded products.

ELECTRONIC CONTROL SUSPENSION (IF EQUIPPED)

Electronic Control Suspension controls the vehicle suspension automatically using vehicle sensors to maximize driving comfort by taking into account the driving conditions such as speed, surface of the road, cornering, stopping requirements and acceleration.

System malfunction

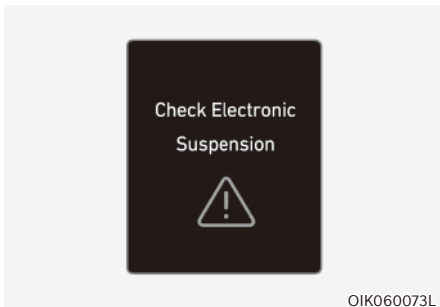

OIK060073L

Check Electronic Suspension

When Electronic Control Suspension is not working properly, this warning message will appear on the cluster LCD display. If this occurs, we recommend that the system be inspected by an authorized retailer of Genesis Branded products.

ELECTRONICALLY CONTROLLED SUSPENSION WITH ROAD PREVIEW (IF EQUIPPED)

Electronically Controlled Suspension with Road Preview will help control the vehicle suspension automatically using the front view camera and vehicle sensors to maximize driving comfort by taking into account the driving conditions such as speed, surface of the road, cornering, stopping requirements and acceleration.

Front View Camera

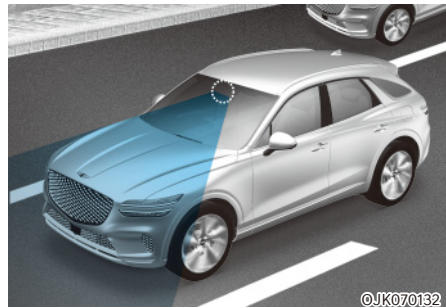

©JK070132

The Front View Camera is a sensor that detects the front road. If the windshield or the front view camera is covered with snow, rain or foreign matters, the data collected by the camera is limited due to the degradation of the camera's performance. Always keep the front view camera clean.

NOTICE

- **NEVER** install any accessories or stickers on the front windshield, or tint the front windshield.
- **NEVER** place any reflective objects (for example, white paper, mirror) over the dashboard. Any light reflection may prevent the system from functioning properly.
- Pay extreme caution to keep the camera dry.
- Never disassemble the camera assembly, or apply any impact on the camera assembly.

**Information**

We recommend that the system be inspected by an authorized retailer of Genesis Branded products when:

- The windshield glass is replaced.
- The front view camera or cover gets damaged or replaced.

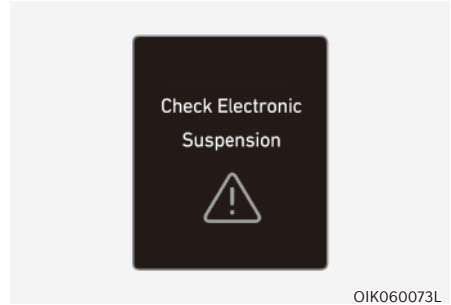
System malfunction**Check Electronic Suspension**

When Electronically Controlled Suspension with Road Preview is not working properly, this warning message will appear on the cluster LCD display. If this occurs, we recommend that the system be inspected by an authorized retailer of Genesis Branded products.

NOTICE

If the battery level is high or low, Electronically Controlled Suspension with Road Preview may not work temporarily to protect the system. If this occurs, 'Check Electronic Suspension' warning message will appear.

Limitations of the system

Electronically Controlled Suspension with Road Preview always operates while driving according to the vehicle's movement, and the preview function starts to work when the front view camera detects road conditions such as speed bumps. Therefore, the preview function is limited when there is an extreme condition that the front view camera may not work normally. In this case, the electronic control suspension function operates without the preview function in accordance with vehicle movement.

LAUNCH CONTROL (IF EQUIPPED)

The Launch Control system controls the vehicle to reduce wheel spin or slip on a hard acceleration from a standing start.

Prerequisite for activation

The Launch Control gets ready to be activated, when the following prerequisites are satisfied.

- The engine is warmed up.
- Malfunction warning lights related to the engine and ESC (Electronic Stability Control) are off.

CAUTION

For safety purposes, check the following conditions before using Launch control.

- **The driver's seat belt is fastened.**
- **All doors, hood and tailgate are closed.**
- **The vehicle is at a complete stop.**
- **Align the steering wheel straight.**

Launch Control activation

To activate Launch Control:

1. Select SPORT or SPORT+ mode using the drive mode selection switch. SPORT or SPORT+ indicator will illuminate on the instrument cluster LCD display.
2. Turn off ESC by pressing the ESC OFF button for more than 3 seconds. The ESC OFF indicator will illuminate on the instrument cluster.
3. Shift to the D (Drive) position.

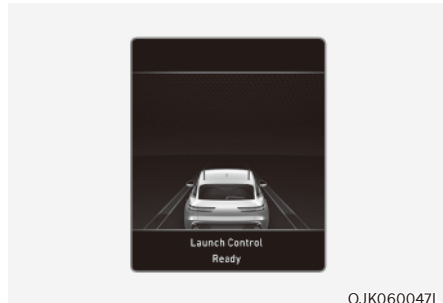

4. Depress the brake pedal firmly with your left foot, while depressing the accelerator pedal down fully with your right foot. Then, the engine RPM will reach an optimized level.
The message 'Launch Control Ready' will appear on the instrument cluster LCD display.
5. A smooth, quick release of the brake pedal, while maintaining full depression of the accelerator pedal will initiate launching of the vehicle.

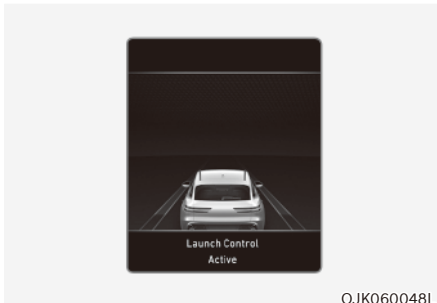

OJK060048L

6. During vehicle launching, continue to depress the accelerator pedal to keep the Launch Control system active until desired duration.

The message 'Launch Control Active' will appear on the cluster LCD display. To deactivate (end) Launch Control, release the accelerator pedal.

Information

Launch Control is available again after cooling down by driving the vehicle for at least 3 minutes.

CAUTION

- Launch Control system is intended for use at a closed race track and not intended for use on public roads. It will not compensate for driver's who are inexperienced or lack familiarity with the race track.
- Do not use Launch Control during break-in period of the vehicle.

NOTICE

Constant use of Launch Control can put enormous stress on the vehicle resulting in premature wear of related components.

Limited use of Launch Control

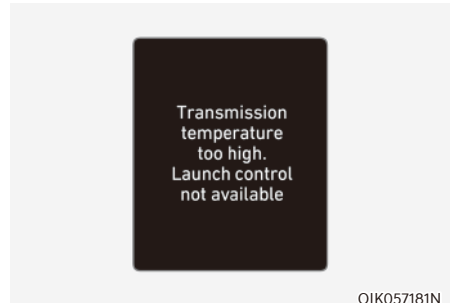

OIK057181N

Transmission temperature too high. Launch control not available

A warning message will pop up on the cluster LCD display if the transmission fluid temperature is above a certain level while using Launch Control. Also, Launch Control will be automatically deactivated.

If this occurs, the driver should cool down the transmission fluid temperature by driving the vehicle at a constant speed over 60 km/h (37 mph).

IDLE STOP AND GO (ISG) (IF EQUIPPED)

Idle Stop and Go helps reduce fuel consumption by automatically shutting down the engine, when the vehicle is at a standstill (for example, red stop light, stop sign, and traffic jam) subject to certain prerequisite conditions being satisfied as listed below.

The engine is automatically started upon satisfying the starting conditions.

ISG system is always active, when the engine is running.

Information

When the engine is automatically started by ISG system, warning lights (for example, ABS, ESC, ESC OFF, EPS, and parking brake warning light) may illuminate for a few seconds due to low battery voltage.

However, it does not indicate a malfunction with ISG system.

ISG system operation

Prerequisite for activation

ISG system operates in the following situations.

- The driver's seatbelt is fastened
- The driver's door and hood are closed
- The brake vacuum pressure is adequate
- The battery sensor is activated and the battery is sufficiently charged
- Outside temperature is not too low or too high
- The vehicle is driven over a constant speed and stops
- The climate control system satisfies the conditions

- The vehicle is sufficiently warmed up
- ISG related parts are working properly
- The incline is gradual
- The steering wheel is turned less than 180 degrees and then the vehicle stops
- The drive mode is not set to SPORT+ or multi terrain mode

Information

ISG system is not activated, when the prerequisites to activate the ISG system are unsatisfied.

Auto stop

When ISG is on the engine will be stopped automatically when both of the following occurs:

1. Vehicle speed decreases to 0 km/h (0 mph) full stop condition.
2. Brake pedal is depressed and gear is in D (Drive) or N (Neutral).

The Auto Stop ((A)) indicator illuminates in green on the instrument cluster, when the engine stops.

Information

Idle stop cannot reoccur again until the vehicle speed goes above 5 km/h (3 mph) and then returns again to the automatic stop conditions as previously mentioned.

In the Auto Stop mode, if the engine hood is opened, ISG system will be deactivated.

When the system is deactivated, the ISG off button indicator will illuminate and a message 'Auto Stop error. Shift to P or N to start engine manually' appears on the cluster LCD display with a warning sound.

If this occurs, depress the brake pedal and restart the engine manually.

Auto start

When the engine stops automatically by ISG, the engine will restart if one of the following is done.

- Release the brake pedal.
- When Auto Hold is activated, take your foot off the brake pedal and then depress the accelerator pedal.
- While depressing the brake pedal, shift the gear from N (Neutral) or D (Drive) to R (Reverse) or P (Park).
- While depressing the brake pedal, shift the gear from N (Neutral) to D (Drive).

LCD display messages

The messages are displayed on the instrument cluster to help use ISG system.

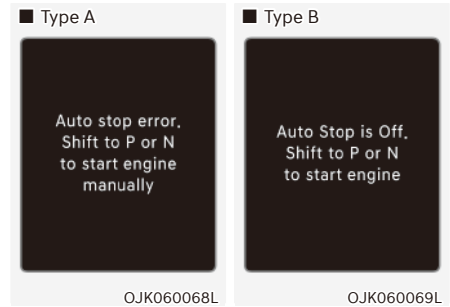

Auto stop error. Shift to P or N to start engine manually / Auto Stop is Off. Shift to P or N to start engine

When the system is deactivated, the ISG off button indicator will illuminate and a message will appear on the cluster LCD display with a warning sound in the following situations.

- When the engine hood is opened.
- When ISG system is not working normally.

If this occurs, depress the brake pedal and restart the engine manually. For your safety, restart the vehicle in the P (Park) position.

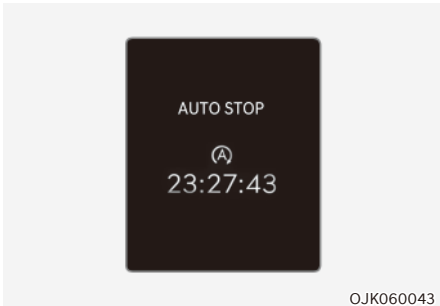

AUTO STOP elapsed time

AUTO STOP display shows the elapsed time of engine stop by the Idle Stop and Go system.

You may check AUTO STOP elapsed time in the Utility view on the instrument cluster.

Refer to “View Modes” section in chapter 4.

ISG system off

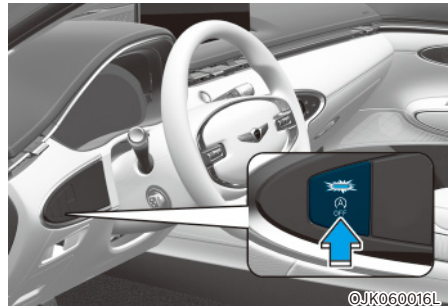

Press the ISG OFF button to turn off ISG system. The ISG OFF button indicator will illuminate. To use the system, press the ISG OFF button again.

Forced to Restart Engine

The engine is automatically restarted in the following situations.

- The brake vacuum pressure is low
- The engine has stopped for about 5 minutes
- The air conditioning is ON with the fan speed set to a certain high level
- The front defroster is ON
- The battery is weak
- The cooling and heating performance of the climate control system is unsatisfactory
- The vehicle is shifted to P (Park) or R (Reverse)
- The door is opened or the seatbelt is unfastened
- The EPB switch is pressed when Auto Hold is activated

The Auto Stop ((A)) indicator blinks in green for 5 seconds on the instrument cluster when the engine is restarted.



WARNING

When the engine is in Idle Stop mode, the engine may restart without the driver taking any action. Before leaving the vehicle or working on the engine compartment, turn off the engine by pressing the ENGINE START/STOP button to the OFF position.

ISG malfunction

ISG system may not operate when there is a malfunction with the ISG sensors or ISG system.

The following will occur, when there is a malfunction with the ISG system:

- The Auto Stop ((A)) indicator will illuminate in yellow on the instrument cluster.
- The light on the ISG OFF button will illuminate.

We recommend that you contact an authorized retailer of Genesis Branded products.

Calibrating the Battery Sensor

If the AGM battery is reconnected or replaced, ISG system will not operate immediately. If you want to use the system, the battery sensor needs to be calibrated following the below procedure.

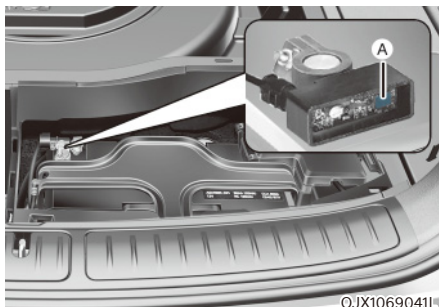

OJX1069041L

[A] : Battery sensor

1. Turn off the engine.
2. Disconnect all electronic devices that were additionally installed after the vehicle was delivered, such as navigation, dashcam, etc.
3. After 4 hours with the engine off, turn the engine on and off 3 to 4 times.

i **Information**

The ISG system may not operate in the following situations.

- There is a malfunction with the ISG system.
- The battery is weak.
- The brake vacuum pressure is low.

If this occurs, have the ISG system checked by an authorized retailer of Genesis Branded products.

NOTICE

- Use only a genuine Genesis ISG battery for replacement. If not, the ISG system may not properly operate.
- Do not recharge the ISG battery with a general battery charger. It may damage or explode the ISG battery.
- Do not remove the battery cap. The battery electrolyte, which is harmful to the human body, may leak out.

COASTING (IF EQUIPPED)

When certain conditions are met, the engine is automatically decoupled from the transmission while gear remains in D (Drive). When Coasting is operating, the engine stays at idling speed to reduce fuel consumption and increase coasting distance.

Coasting setting

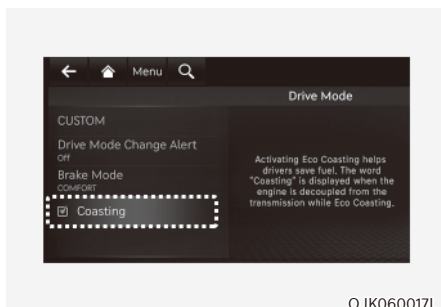

OJK060017L

- The Coasting function must be turned ON from the Settings menu in the infotainment system screen. Select:

- Setup → Vehicle Settings → Drive Mode → Coasting

For detailed information, scan the QR code in a separately supplied simple manual.

- When Coasting is turned ON and the conditions are met, the function operates with a 'Coasting' message illuminated on the instrument cluster.

Coasting operating conditions

Coasting function will operate when the accelerator pedal is depressed and released under the following conditions.

- ECO is selected for driving mode
- ECO or Smart is selected for Powertrain in the CUSTOM menu (if equipped) from the infotainment system screen. If Smart is selected, driver acceleration should be mild
- The gear is in D (Drive)
- Smart Cruise Control button is OFF
- Smart Cruise function is in standby
- The accelerator or brake pedal is not depressed
- The vehicle's speed is within 50~160 km/h (30~100 mph) range
- The road gradient is within -5~+5% range

i Information

- **If the front radar for Smart Cruise Control cannot operate normally, the inter-vehicle distance and relative speed condition are automatically ignored.**
- **The Coasting function works after the engine is turned on, the transmission is warmed up, and the engine sensor self-diagnosis is completed.**
- **Depending on the driving situation, Coasting operation may be temporarily delayed even if the above conditions are met.**

Coasting release conditions

The Coasting function will be automatically released when the following conditions are met.

- COMFORT, SPORT, or SPORT+ mode is selected for driving mode
- The driver uses the paddle shifter
- Smart Cruise Control is activated (Set speed appears on the cluster)
- The vehicle's speed exceeds 50~160 km/h (30~100 mph) range
- The road gradient is under -5% or over +5%
- If the distance between the vehicle ahead is too close or the relative speed changes momentarily in Smart mode
- If lane change is predicated in Smart mode (for example, the turn signal is turned ON or a LKA warning appears due to steering wheel control, etc.)



Information

It is recommended to turn off the Coasting function if you are driving under frequently stop-and-go condition. Change the drive mode to Comfort or Sport or deselect Coasting from the infotainment system screen.

NOTICE

- **If the accelerator pedal is pressed quickly for accelerating with the Coasting function in operation, acceleration may occur after the engagement of the clutch inside the transmission. In turn, the driver may continue to feel acceleration even after the system is turned off.**
- **Driving with the Coasting function off may be required in some cases since the engine brake is not applied while the Coasting function is operating.**
- **Operating the infotainment system screen to activate or deactivate the Coasting function while driving may be dangerous as the driver's attention is distracted.**

DRIVE MODE INTEGRATED CONTROL SYSTEM (2WD) (IF EQUIPPED)

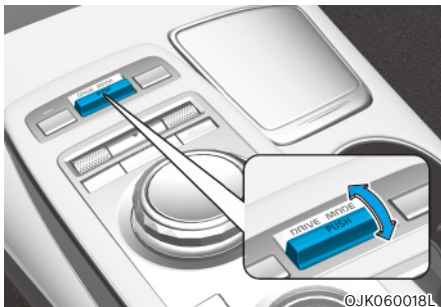

Drive mode may be selected according to the driver's preference or road condition.

Drive mode

The mode changes whenever the driver pushes the DRIVE MODE switch up or down.

COMFORT mode

COMFORT mode provides smooth driving and comfortable riding.

ECO mode



ECO mode helps improve fuel efficiency for eco-friendly driving.

Fuel efficiency varies according to the driver's driving habit and road condition.

- When ECO mode is selected, the ECO indicator will illuminate on the instrument cluster.
- When ECO mode is activated:
 - The acceleration response may be slightly reduced if the accelerator pedal is depressed moderately.
 - The air conditioner performance may be limited.
 - The shift pattern of the automatic transmission may change.
 - Engine noise may be louder at some automatic transmission shifts as down-shift requires pressing down more on the accelerator.

The above situations are normal conditions when ECO mode is activated to help improve fuel efficiency.

Limitations of ECO mode

If the following conditions occur while ECO mode is operating, the system operation is limited even though there is no change in the ECO indicator.

- When coolant temperature is low:
The system will be limited until engine performance becomes normal.
- When driving up a hill:
The system will be limited to gain power when driving uphill because engine torque is restricted.
- When driving the vehicle in manual shift mode using the paddle shifter.
The system will be limited according to the shift location.

SPORT mode

SPORT SPORT mode provides sporty but firm riding.

In SPORT mode, the fuel efficiency may decrease.

- When SPORT mode is selected, the SPORT indicator will illuminate on the instrument cluster.
- Whenever the engine is restarted, the drive mode will revert back to COMFORT mode. If SPORT mode is desired, re-select SPORT mode.
- When SPORT mode is activated:
 - The engine RPM will tend to remain raised over a certain length of time even after releasing the accelerator
 - Upshifts are delayed when accelerating

SPORT+ mode (if equipped)

SPORT+ SPORT+ mode provides sporty but firm riding.

In SPORT+ mode, the fuel efficiency may decrease.

- When SPORT+ mode is selected, the SPORT+ indicator will illuminate on the instrument cluster.
- Whenever the engine is restarted, the drive mode will revert back to COMFORT mode. If SPORT+ mode is desired, re-select SPORT+ mode.
- When SPORT+ mode is activated:
 - RPM increase while idling
 - The engine RPM will tend to remain raised over a certain length of time even after releasing the accelerator
 - Upshifts are delayed when accelerating
 - ESC OFF state 1 will be automatically set

NOTICE

- In **SPORT** or **SPORT+** mode, the fuel efficiency may decrease.
- **ISG** and **Smart Cruise Control** are deactivated in **SPORT+** mode.

CUSTOM mode (if equipped)

CUSTOM In CUSTOM mode, the driver can select separate modes for each item in the infotainment system screen.

- Powertrain
Standard model: ECO/Comfort/Sport/Smart
Sport model: ECO/Comfort/Sport/Sport +/Smart
- Steering wheel: Comfort/Sport
- Suspension: Comfort/Sport
(if equipped with ECS)

For detailed information, scan the QR code in a separately supplied simple manual.

- When CUSTOM mode is selected, the CUSTOM indicator will illuminate on the instrument cluster.
- Whenever the engine is restarted, the drive mode will revert back to COMFORT mode. If CUSTOM mode is desired, re-select CUSTOM mode.

DRIVE MODE INTEGRATED CONTROL SYSTEM (AWD) (IF EQUIPPED)

Drive mode

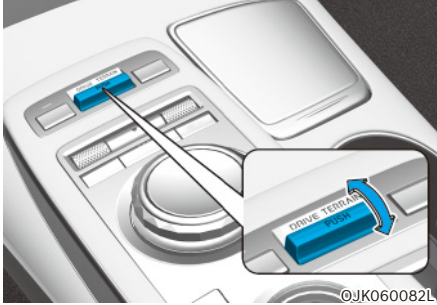

Drive mode may be selected according to the driver's preference or road condition.

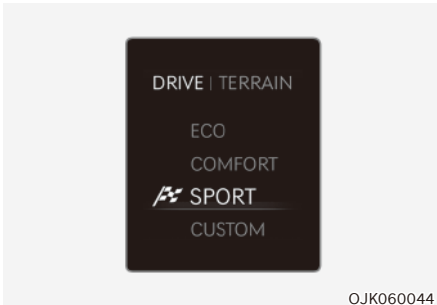

The mode changes whenever the driver pushes the DRIVE/TERRAIN switch up or down.

COMFORT mode

COMFORT mode provides smooth driving and comfortable riding.

ECO mode

ECO ECO mode helps improve fuel efficiency for eco-friendly driving.

Fuel efficiency varies according to the driver's driving habit and road condition.

- When ECO mode is selected, the ECO indicator will illuminate on the instrument cluster.
- When ECO mode is activated:
 - The acceleration response may be slightly reduced if the accelerator pedal is depressed moderately.
 - The air conditioner performance may be limited.
 - The shift pattern of the automatic transmission may change.
 - Engine noise may be louder at some automatic transmission shifts as down-shift requires pressing down more on the accelerator.

The above situations are normal conditions when ECO mode is activated to help improve fuel efficiency.

Limitations of ECO mode

If the following conditions occur while ECO mode is operating, the system operation is limited even though there is no change in the ECO indicator.

- When coolant temperature is low:
The system will be limited until engine performance becomes normal.
- When driving up a hill:
The system will be limited to gain power when driving uphill because engine torque is restricted.
- When driving the vehicle in manual shift mode using the paddle shifter.

The system will be limited according to the shift location.

SPORT mode

SPORT SPORT mode provides sporty but firm riding.

In SPORT mode, the fuel efficiency may decrease.

- When SPORT mode is selected, the SPORT indicator will illuminate on the instrument cluster.
- Whenever the engine is restarted, the drive mode will revert back to COMFORT mode. If SPORT mode is desired, re-select SPORT mode.
- When SPORT mode is activated:
 - The engine RPM will tend to remain raised over a certain length of time even after releasing the accelerator
 - Upshifts are delayed when accelerating

SPORT+ mode (if equipped)

SPORT+ SPORT+ mode provides sporty but firm riding.

In SPORT+ mode, the fuel efficiency may decrease.

- When SPORT+ mode is selected, the SPORT+ indicator will illuminate on the instrument cluster.
- Whenever the engine is restarted, the drive mode will revert back to COMFORT mode. If SPORT+ mode is desired, re-select SPORT+ mode.
- When SPORT+ mode is activated:
 - RPM increase while idling
 - The engine RPM will tend to remain raised over a certain length of time even after releasing the accelerator
 - Upshifts are delayed when accelerating
 - ESC OFF state 1 will be automatically set

NOTICE

- In **SPORT** or **SPORT+** mode, the fuel efficiency may decrease.
- **ISG** and **Smart Cruise Control** are deactivated in **SPORT+** mode.

CUSTOM mode (if equipped)

CUSTOM In CUSTOM mode, the driver can select separate modes for each item in the infotainment system screen.

- Powertrain
Standard model: ECO/Comfort/Sport/Smart
Sport model: ECO/Comfort/Sport/Sport +/Smart
- Steering wheel: Comfort/Sport
- Suspension: Comfort/Sport (if equipped with ECS)
- AWD (if equipped): ECO/Comfort/Sport

For detailed information, scan the QR code in a separately supplied simple manual.

- When CUSTOM mode is selected, the CUSTOM indicator will illuminate on the instrument cluster.
- Whenever the engine is restarted, the drive mode will revert back to COMFORT mode. If CUSTOM mode is desired, re-select CUSTOM mode.

Vehicle characteristic

The characteristic of each components varies according to which drive mode is selected.

	Component	DRIVE MODE			
		ECO	COMFORT Mode	SPORT Mode	SPORT+ Mode
Engine & Driving	Power train	ECO	COMFORT	SPORT	SPORT+
	Launch Control	X	Off	On	On
Chassis	Steering	COMFORT	COMFORT	SPORT	SPORT
	ESC*1	COMFORT	COMFORT	SPORT	SPORT (TCS*2 OFF)
	Suspension	COMFORT	COMFORT	SPORT	SPORT
Sound	ASD*3	ECO	COMFORT	SPORT	SPORT

When driving in CUSTOM mode, Launch Control/Active Sound Design may vary depending on the CUSTOM mode-Powertrain system settings.

*1: Electronic Stability Control

*2: Traction Control System

*3: Active Sound Design

Multi terrain mode

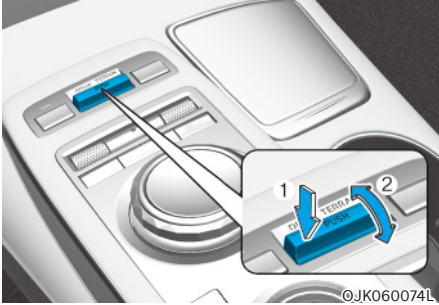

Multi terrain mode may be selected according to the driver's preference or road condition.

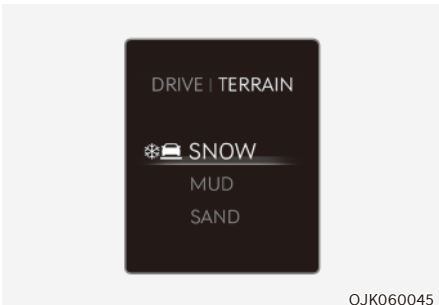

Push (1) the DRIVE/TERRAIN switch to change from Drive mode to Multi terrain mode. After the switch is pushed, push the DRIVE/TERRAIN switch up or down (2) within 4 seconds to select SNOW, MUD or SAND. When the DRIVE/TERRAIN switch is pushed again, the previous Drive mode will be reselected.

For more details on Terrain mode, refer to “All Wheel Drive” section in this chapter.

ACTIVE SOUND DESIGN

- Active Sound Design is a function that provides enhanced virtual engine sound when the driver is depressing the accelerator pedal.
- You can activate or deactivate Active Sound Design function from the Settings menu in the infotainment system screen. Select:
 - Setup → Vehicle Settings → Active Sound Design → Enhanced/Standard/Minimized/Off, or
 - Setup → Sound Settings → Active Sound Design → Enhanced/Standard/Minimized/Off
- Any unauthorized replacement of the vehicle's speaker and amplifier may cause Active Sound Design to malfunction.

SEMI ACTIVE ENGINE MOUNT (IF EQUIPPED)

If the Semi Active Engine Mount is equipped to improve vehicle's noise and vibration, the solenoid valve of the semi active engine mount makes a clack sound when the vehicle enters or exits a certain mode such as speed or engine RPM. It is not a malfunction but it is a normal condition.

SPECIAL DRIVING CONDITIONS

Hazardous driving conditions

When hazardous driving elements are encountered such as water, snow, ice, mud and sand, take the following precautions:

- Drive cautiously and maintain a longer braking distance.
- Avoid abrupt braking or steering.
- When your vehicle is stuck in snow, mud, or sand, use second gear. Accelerate slowly to avoid unnecessary wheel spin.
- Put sand, rock salt, tire chains or other non-slip materials under the wheels to provide additional traction while the vehicle becomes stuck in ice, snow, or mud.



WARNING

Downshifting with an automatic transmission while driving on slippery surfaces can cause an accident. The sudden change in tire speed could cause the tires to skid. Be careful when downshifting on slippery surfaces.

Rocking the vehicle

If it is necessary to rock the vehicle to free it from snow, sand, or mud, first turn the steering wheel right and left to clear the area around your front wheels. Then, shift back and forth between R (Reverse) and a forward gear.

Try to avoid spinning the wheels, and do not race the engine.

To prevent transmission wear, wait until the wheels stop spinning before shifting gears. Release the accelerator pedal while shifting, and press lightly on the accelerator pedal while the transmission is in gear. Slowly spinning the wheels in forward and reverse directions causes a rocking motion that may free the vehicle.



WARNING

If the vehicle is stuck and excessive wheel spin occurs, the temperature in the tires can increase very quickly. If the tires become damaged, a tire blow out or tire explosion can occur. This condition is dangerous - you and others may be injured. Do not attempt this procedure if people or objects are anywhere near the vehicle.

If you attempt to free the vehicle, the vehicle can overheat quickly, possibly causing an engine compartment fire or other damage. Try to avoid spinning the wheels as much as possible to prevent overheating of either the tires or the engine. DO NOT allow the vehicle to spin the wheels above 56 km/h (35 mph).

Information

The ESC system must be turned OFF before rocking the vehicle.

NOTICE

If you are still stuck after rocking the vehicle a few times, have the vehicle pulled out by a tow vehicle to avoid engine overheating, possible damage to the transmission, and tire damage. See “Towing” section in chapter 8.

Smooth cornering

Avoid braking or gear changing in corners, especially when roads are wet. Ideally, corners should always be taken under gentle acceleration.

Driving at night

Night driving presents more hazards than driving in the daylight. Here are some important tips to remember:

- Slow down and keep more distance between you and other vehicles, as it may be more difficult to see at night, especially in areas where there may not be any street lights.
- Adjust your mirrors to reduce the glare from other drivers' headlamps.
- Keep your headlamps clean and properly aimed. Dirty or improperly aimed headlamps will make it much more difficult to see at night.
- Avoid staring directly at the headlamps of oncoming vehicles. You could be temporarily blinded, and it will take several seconds for your eyes to readjust to the darkness.

Driving in the rain

Rain and wet roads can make driving dangerous. Here are a few things to consider when driving in the rain or on slick pavement:

- Slow down and allow extra following distance. A heavy rainfall makes it harder to see and increases the distance needed to stop your vehicle.
- Turn OFF your Cruise Control. (if equipped)
- Replace your windshield wiper blades when they show signs of streaking or missing areas on the windshield.
- Be sure your tires have enough tread. If your tires do not have enough tread, making a quick stop on wet pavement can cause a skid and possibly lead to an accident. See “Tire Tread” section in chapter 9.
- Turn on your headlamps to make it easier for others to see you.
- Driving too fast through large puddles can affect your brakes. If you must go through puddles, try to drive through them slowly.
- If you believe your brakes may be wet, apply them lightly while driving until normal braking operation returns.

Hydroplaning

If the road is wet enough and you are going fast enough, your vehicle may have little or no contact with the road surface and actually ride on the water. The best advice is SLOW DOWN when the road is wet.

The risk of hydroplaning increases as the depth of tire tread decreases, refer to “Tire Tread” section in chapter 9.

Driving in flooded areas

Avoid driving through flooded areas unless you are sure the water is no higher than the bottom of the wheel hub. Drive through any water slowly. Allow adequate stopping distance because brake performance may be reduced.

After driving through water, dry the brakes by gently applying them several times while the vehicle is moving slowly.

Highway driving

Tires

Adjust the tire inflation, as specified. Under-inflation may overheat or damage the tires.

Do not install worn-out or damaged tires, which may reduce traction or fail the braking operation.

Information

Never over-inflate your tires above the maximum inflation pressure, as specified on your tires.

Fuel, engine coolant and engine oil

Driving at higher speeds on the highway consumes more fuel and is less efficient than driving at a slower, more moderate speed. Maintain a moderate speed in order to conserve fuel when driving on the highway.

Be sure to check both the engine coolant level and the engine oil before driving.

Drive belt

A loose or damaged drive belt may overheat the engine.

Reducing the risk of a rollover

Your multi-purpose passenger vehicle is defined as a Sports Utility Vehicle (SUV). SUV's have higher ground clearance and a narrower track to make them capable of performing in a wide variety of off-road applications. The specific design characteristics give them a higher center of gravity than ordinary vehicles making them more likely to roll over if you make abrupt turns. Utility vehicles have a significantly higher rollover rate than other types of vehicles. Due to this risk, driver and passengers are strongly recommended to buckle their seat belts. In a rollover crash, an unbelted person is significantly more likely to die than a person wearing a seat belt.

There are steps that a driver can make to reduce the risk of a rollover. If at all possible, avoid sharp turns or abrupt maneuvers, do not load your vehicle with heavy cargo on the roof, and never modify your vehicle in any way.



WARNING

Utility vehicles have a significantly higher rollover rate than other types of vehicles. To prevent rollovers or loss of control:

- **Take corners at slower speeds than you would with a passenger vehicle.**
- **Avoid sharp turns and abrupt maneuvers.**
- **Do not modify your vehicle in any way that you would raise the center of gravity.**
- **Keep tires properly inflated.**
- **Do not carry heavy cargo on the roof.**



WARNING

In a rollover crash, an unbelted person is significantly more likely to die than a person wearing a seat belt. Make sure all passengers are wearing their seat belts.

WINTER DRIVING

The severe weather conditions of winter quickly wear out tires and cause other problems. To minimize winter driving problems, you should take the following suggestions:

Snow or icy conditions

You need to keep sufficient distance between your vehicle and the vehicle in front of you.

Apply the brakes gently. Speeding, rapid acceleration, sudden brake applications, and sharp turns are potentially very hazardous practices. During deceleration, use engine braking to the fullest extent. Sudden brake applications on snowy or icy roads may cause the vehicle to skid.

To drive your vehicle in deep snow, it may be necessary to use snow tires or to install tire chains on your tires.

Always carry emergency equipment. Some of the items you may want to carry include tire chains, tow straps or chains, a flashlight, emergency flares, sand, a shovel, jumper cables, a window scraper, gloves, ground cloth, coveralls, a blanket, etc.

Snow tires



WARNING

Snow tires should be equivalent in size and type to the vehicle's standard tires. Otherwise, the safety and handling of your vehicle may be adversely affected.

We recommend that you use snow tires when road temperature is below 7°C (45°F). Refer to the below chart, and mount the recommended snow tire for your vehicle.

Standard tire		Recommended snow tire	
Tire size	Wheel size	Tire size	Wheel size
235/60R18	8.0J X 18	235/60R18	8.0J X 18
		235/55R19	8.0J X 19
		255/40R21	9.0J X 21
235/55R19	8.0J X 19	235/55R19	8.0J X 19
255/40R21	9.0J X 21	255/40R21	9.0J X 21

If you mount snow tires on your vehicle, make sure to use the same Inflation pressure as the original tires. Mount snow tires on all four wheels to balance your vehicle's handling in all weather conditions. The traction provided by snow tires on dry roads may not be as high as your vehicle's original equipment tires. Check with the tire dealer for maximum speed recommendations.

Summer tires (if equipped)

- Summer tires are used to maximize the driving performance on dry roads.
- If the temperature is below 7°C or you are driving on snowy or icy roads, the summer tires lose their brake performance and traction as the tire grip weakens significantly.
- If the temperature is below 7°C or you are driving on snowy or icy roads, mount snow tires or all-season tires of the same size with your vehicle's standard tire for safe driving. Both snow and all-season tires have M+S markings.
- When using the M+S tires, use tires with the same tread produced by the same manufacturer for safe driving.
- When driving with the M+S tires with the lower maximum allowable speed than that of the vehicle's standard summer tire, be careful not to exceed the speed allowed for the M+S tires.

Tire chains



Since the sidewalls of radial tires are thinner than other types of tires, they may be damaged by mounting some types of tire chains on them. Therefore, the use of snow tires is recommended instead of tire chains. If tire chains must be used, use genuine Genesis/Hyundai parts and install the tire chain after reviewing the instructions provided with the tire chains. Damage to your vehicle caused by improper tire chain use is not covered by your vehicle manufacturer's warranty.



WARNING

The use of tire chains may adversely affect vehicle handling:

- Drive less than 30 km/h (20 mph) or the chain manufacturer's recommended speed limit, whichever is lower.
- Drive carefully and avoid bumps, holes, sharp turns, and other road hazards, which may cause the vehicle to bounce.
- Avoid sharp turns or locked wheel braking.



Information

- Install tire chains only in pairs and on the rear tires. It should be noted that installing tire chains on the tires will provide a greater driving force, but will not prevent side skids.
- Do not install studded tires without first checking local and municipal regulations for possible restrictions against their use.

Chain Installation

When installing tire chains, follow the manufacturer's instructions and mount them as tightly possible. Drive slowly (less than 30 km/h (20 mph)) with chains installed. If you hear the chains contacting the body or chassis, stop and tighten them. If they still make contact, slow down until the noise stops. Remove the tire chains as soon as you begin driving on cleared roads.

When mounting snow chains, park the vehicle on level ground away from traffic. Turn on the vehicle Hazard Warning Flasher and place a triangular emergency warning device behind the vehicle (if available). Always place the vehicle in P (Park), apply the parking brake and turn off the engine before installing snow chains.

NOTICE

When using tire chains:

- Wrong size chains or improperly installed chains can damage your vehicle's brake lines, suspension, body and wheels.
- Use SAE "S" class or wire chains.
- If you hear noise caused by chains contacting the body, retighten the chain to prevent contact with the vehicle body.
- To prevent body damage, retighten the chains after driving 0.5~1.0 km (0.3~0.6 miles).
- Do not use tire chains on vehicles equipped with aluminum wheels. If unavoidable, use a wire type chain.
- Use wire chains less than 12 mm (0.47 in.) thick to prevent damage to the chain's connection.

Winter precautions

Use high quality ethylene glycol coolant

Your vehicle is delivered with high quality ethylene glycol coolant in the cooling system. It is the only type of coolant that should be used because it helps prevent corrosion in the cooling system, lubricates the water pump and prevents freezing. Be sure to replace or replenish your coolant in accordance with the maintenance schedule in chapter 9. Before winter, have your coolant tested to assure that its freezing point is sufficient for the temperatures anticipated during the winter.

Check battery and cables

Winter temperatures affect battery performance. **Inspect the battery and cables, as specified in chapter 9.** The battery charging level can be checked by an authorized retailer of Genesis Branded products or in a service station.

Change to “winter weight” oil if necessary

In some regions during winter, it is recommended to use the “winter weight” oil with lower viscosity. In addition, replace the engine oil and filter if it is close to the next maintenance interval. Fresh engine oil ensures optimum engine operation during the winter months. For further information, refer to chapter 2. When you are not sure about a type of winter weight oil, we recommend that you consult an authorized retailer of Genesis Branded products.

Check spark plugs and ignition system

Inspect the spark plugs, as specified in chapter 9. If necessary, replace them. Also check all ignition wirings and components for any cracks, wear-out, and damage.

To prevent locks from freezing

To prevent the locks from being frozen, spray approved de-icing fluid or glycerin into key holes. When a lock opening is already covered with ice, spray approved de-icing fluid over the ice to remove it. When an internal part of a lock freezes, try to thaw it with a heated key. Carefully use the heated key to avoid an injury.

Use approved window washer anti-freeze solution in system

To prevent the window washer from being frozen, add authorized window washer anti-freeze solution, as specified on the window washer container. Window washer anti-freeze solution is available from an authorized retailer of Genesis Branded products, and most vehicle accessory outlets. Do not use engine coolant or other types of anti-freeze solution, to prevent any damage to the vehicle paint.

Do not let your parking brake freeze

Under some conditions your parking brake can freeze in the engaged position. This is most likely to happen when there is an accumulation of snow or ice around or near the rear brakes or if the brakes are wet. When there is the risk that your parking brake may freeze, temporarily apply it with the gear in P (Park). Also, block the rear wheels in advance, so the vehicle may not roll. Then, release the parking brake.

Do not let ice and snow accumulate underneath

Under some conditions, snow and ice can build up under the fenders and interfere with the steering. When driving in such conditions during the severe winter, you should check underneath the vehicle on a regular basis, to ensure that the front wheels and the steering components is unblocked.

Carry emergency equipment

In accordance with weather conditions, you should carry appropriate emergency equipment, while driving. Some of the items you may want to carry include tire chains, tow straps or chains, flashlight, emergency flares, sand, shovel, jumper cables, window scraper, gloves, ground cloth, coveralls, blanket, etc.

Do not place objects or materials in the engine compartment

Putting objects or materials in the engine compartment may cause an engine failure or combustion, because they may block the engine cooling. Such damage will not be covered by the manufacturer's warranty.

TRAILER TOWING

If you are considering to tow with your vehicle, you should first your country's legal requirements. As laws vary the requirements for towing trailers, cars, or other types of vehicles or apparatus may differ. Ask an authorized retailer of Genesis Branded products for further details before towing.

Remember that trailering is different than just driving your vehicle by itself. Trailering means changes in handling, durability, and fuel economy. Successful, safe trailering requires correct equipment, and it has to be used properly. Damage to your vehicle caused by improper trailer towing is not covered by your vehicle manufacturer's warranty.

This section contains many time-tested, important trailering tips and safety rules. Many of these are important for your safety and that of your passengers. Please read this section carefully before you pull a trailer.



WARNING

Take the following precautions:

- **If you don't use the correct equipment and/or drive improperly, you can lose control of the vehicle when you are pulling a trailer. For example, if the trailer is too heavy, the braking performance may be reduced. You and your passengers could be seriously or fatally injured. Pull a trailer only if you have followed all the steps in this section.**
- **Before towing, make sure the total trailer weight, GCW (Gross Combination Weight), GVW (Gross Vehicle Weight), GAW (Gross Axle Weight) and trailer tongue load are all within the limits.**
- **When you tow a trailer, make sure to turn off the Idle Stop and Go system.**



Information - For Europe

- **The technically permissible maximum load on the rear axle(s) may be exceeded by not more than 15 % and the technically permissible maximum laden mass of the vehicle may be exceeded by not more than 10% or 100 kg (220.4 lbs), whichever value is lower. In this case, do not exceed 100 km/h (62.1 mph) for vehicle of category M1 or 80 km/h (49.7 mph) for vehicle of category N1.**
- **When a vehicle of category M1 is towing a trailer, the additional load imposed at the trailer coupling device may cause the tire maximum load ratings to be exceeded, but not by more than 15%. In this case, do not exceed 100 km/h (62.1 mph) and increase the tire inflation pressure by at least 0.2 bar.**
- * M1 : passenger vehicle (9-seater or under)
- * N1 : commercial vehicle (3.5 ton or under)

If you decide to pull a trailer?

Here are some important points if you decide to pull a trailer:

- Consider using a sway control. You can ask a trailer hitch dealer about sway control.
- Do not do any towing with your vehicle during its first 2,000 km (1,200 miles) in order to allow the engine to properly break in. Failure to heed this caution may result in serious engine or transmission damage.
- When towing a trailer, be sure to consult an authorized retailer of Genesis Branded products for further information on additional requirements such as a towing kit, etc.
- Always drive your vehicle at a moderate speed (less than 100 km/h (60 mph)) or posted towing speed limit.
- On a long uphill grade, do not exceed 70 km/h (45 mph) or the posted towing speed limit, whichever is lower.
- Carefully observe the weight and load limits provided in the following pages.

Trailer weight

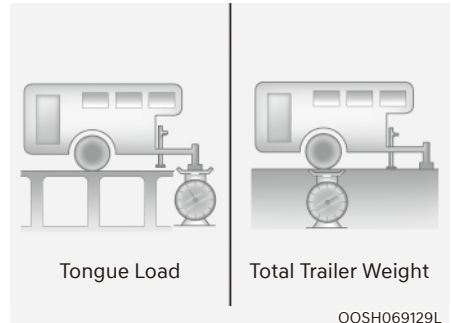

What is the maximum safe weight of a trailer? It should never weigh more than the maximum trailer weight with trailer brakes. But even that can be too heavy. It depends on how you plan to use your trailer. For example, speed, altitude, road grades, outside temperature and how often your vehicle is used to pull a trailer are all important. The ideal trailer weight can also depend on any special equipment that you have on your vehicle.

Tongue load

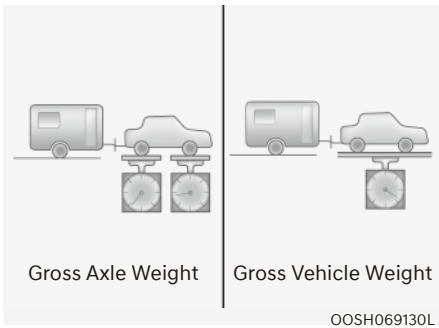

The tongue load is an important weight to measure because it affects the total Gross Vehicle Weight (GVW) of your vehicle. The trailer tongue should weigh a maximum of 10% of the total loaded trailer weight, within the limits of the maximum trailer tongue load permissible.

After you've loaded your trailer, weigh the trailer and then the tongue, separately, to see if the weights are proper. If they aren't, you may be able to correct them simply by moving some items around in the trailer.

WARNING

Take the following precautions:

- Never load a trailer with more weight in the rear than in the front. The front should be loaded with approximately 60% of the total trailer load; the rear should be loaded with approximately 40% of the total trailer load.
- Never exceed the maximum weight limits of the trailer or trailer towing equipment. Improper loading can result in damage to your vehicle and/or personal injury. Check weights and loading at a commercial scale or highway patrol office equipped with scales.

Information

With increasing altitude the engine performance decreases. From 1,000 m above sea level and for every 1,000 m thereafter 10% of vehicle/trailer weight (trailer weight + gross vehicle weight) must be deducted.

Reference weight and distance when towing a trailer

Item		Without trailer package	With trailer package	
			for Europe	except Europe
Maximum trailer weight kg (lbs.)	With brake system	-	2500 (5512)	2000 (4409)
	Without brake system	-	750 (1653)	
Maximum permissible static vertical load on the coupling device kg (lbs.)		-	159 (351)	
Recommended distance from rear wheel center to coupling point mm (inch)		-	1210 (47.6)	

Trailer towing equipment

Hitches

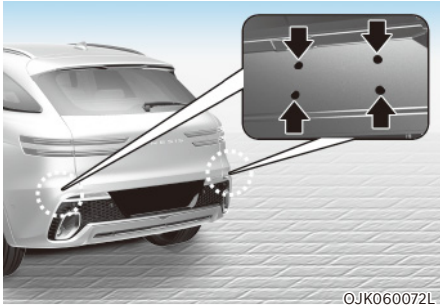

i Information

The mounting hole for hitches are located on both sides of the underbody behind the rear tires.

It's important to have the correct hitch equipment. Crosswinds, large trucks going by, and rough roads are a few reasons why you'll need the right hitch. Here are some rules to follow:

- Do you have to make any holes in the body of your vehicle when you install a trailer hitch? If you do, then be sure to seal the holes later when you remove the hitch. If you don't seal them, carbon monoxide (CO) from your exhaust can get into your vehicle, as well as dirt and water.
- The bumpers on your vehicle are not intended for hitches. Do not attach rental hitches or other bumper-type hitches to them. Use only a frame-mounted hitch that does not attach to the bumper.

- Any part of the rear number plate or lighting devices of the vehicle must not be obscured by the mechanical coupling device.

If the rear number plate and/or lighting devices can be obscured partially by any part of the mechanical coupling device, mechanical coupling devices that can not be easily removed or repositioned without use of any tools, except an easily operated (for example, an effort not exceeding 20Nm) release key which is supplied by the manufacturer of the coupling device, are not permitted for use.

Please note that the mechanical coupling device that is fitted and not in use must always be removed or repositioned if the rear number plate and/or rear lighting devices are obscured by any part of the mechanical coupling device.

- A Genesis Branded Vehicle trailer hitch accessory is available at an authorized retailer of Genesis Branded products.

Safety chains

You should always attach chains between your vehicle and your trailer.

Instructions about safety chains may be provided by the hitch manufacturer or trailer manufacturer. Follow the manufacturer's recommendation for attaching safety chains. Always leave just enough slack so you can turn with your trailer. And, never allow safety chains to drag on the ground.

Trailer brakes

If your trailer is equipped with a braking system, make sure it conforms to your country's regulations and that it is properly installed and operating correctly.

If your trailer weighs more than the maximum trailer weight without trailer brakes loaded, then it needs its own brakes and they must be adequate. Be sure to read and follow the instructions for the trailer brakes so you'll be able to install, adjust and maintain them properly. Be sure not to modify your vehicle's brake system.



WARNING

Do not use a trailer with its own brakes unless you are absolutely certain that you have properly set up the brake system. This is not a task for amateurs. Use an experienced, competent trailer shop for this work.

Driving with a trailer

Towing a trailer requires a certain amount of experience. Before setting out for the open road, you must get to know your trailer. Acquaint yourself with the feel of handling and braking with the added weight of the trailer. And always keep in mind that the vehicle you are driving is now longer and not nearly as responsive as your vehicle is by itself.

Before you start, check the trailer hitch and platform, safety chains, electrical connector(s), lights, tires and brakes.

During your trip, occasionally check to be sure that the load is secure, and that the lights and trailer brakes are still working.

Distance

Stay at least twice as far behind the vehicle ahead as you would when driving your vehicle without a trailer. This can help you avoid situations that require heavy braking and sudden turns.

Passing

You will need more passing distance up ahead when you're towing a trailer. And, because of the increased vehicle length, you'll need to go much farther beyond the passed vehicle before you can return to your lane.

Backing up

Hold the bottom of the steering wheel with one hand. Then, to move the trailer to the left, move your hand to the left. To move the trailer to the right, move your hand to the right. Always back up slowly and, if possible, have someone guide you.

Making turns

When you're turning with a trailer, make wider turns than normal. Do this so your trailer won't strike soft shoulders, curbs, road signs, trees, or other objects. Avoid jerky or sudden maneuvers. Signal well in advance.

Turn signals

When you tow a trailer, your vehicle has to have a different turn signal flasher and extra wiring. The green arrows on your instrument panel will flash whenever you signal a turn or lane change. Properly connected, the trailer lights will also flash to alert other drivers you're about to turn, change lanes, or stop.

When towing a trailer, the green arrows on your instrument panel will flash for turns even if the bulbs on the trailer are burned out. Thus, you may think drivers behind you are seeing your signals when, in fact, they are not. It's important to check occasionally to be sure the trailer bulbs are still working. You must also check the lights every time you disconnect and then reconnect the wires.



WARNING

Do not connect a trailer lighting system directly to your vehicle's lighting system. Use an approved trailer wiring harness. Failure to do so could result in damage to the vehicle electrical system and/or personal injury. Consult an authorized retailer of Genesis Branded products for assistance.

Driving on hills

Reduce speed and shift to a lower gear before you start down a long or steep downgrade. If you don't shift down, you might have to use your brakes so much that they would get overheated and may not operate efficiently.

On a long uphill grade, shift down and reduce your speed to around 70 km/h (45 mph) to reduce the possibility of engine and transmission overheating.

If your trailer weighs more than the maximum trailer weight without trailer brakes and you have a automatic transmission, you should drive in D (Drive) when towing a trailer.

Operating your vehicle in D (Drive) when towing a trailer will minimize heat build-up and extend the life of your transmission.

NOTICE

To prevent engine and/or transmission overheating:

- When towing a trailer on steep grades (in excess of 6%) pay close attention to the engine coolant temperature gauge to ensure the engine does not overheat. If the needle of the coolant temperature gauge moves towards “H” (HOT), pull over and stop as soon as it is safe to do so, and allow the engine to idle until it cools down. You may proceed once the engine has cooled sufficiently.
- If you tow a trailer with the maximum gross vehicle weight and maximum trailer weight, it can cause the engine or transmission to overheat. When driving in such conditions, allow the engine to idle until it cools down. You may proceed once the engine or transmission has cooled sufficiently.
- When towing a trailer, your vehicle speed may be much slower than the general flow of traffic, especially when climbing an uphill grade. Use the right hand lane when towing a trailer on an uphill grade. Choose your vehicle speed according to the maximum posted speed limit for vehicles with trailers, the steepness of the grade, and your trailer weight.

Parking on hills

Generally, if you have a trailer attached to your vehicle, you should not park your vehicle on a hill.

However, if you ever have to park your trailer on a hill, here’s how to do it:

1. Pull the vehicle into the parking space. Turn the steering wheel in the direction of the curb (right if headed down hill, left if headed up hill).
2. Shift the gear to P (Park).
3. Set the parking brake and shut off the vehicle.
4. Place wheel chocks under the trailer wheels on the down hill side of the wheels.
5. Start the vehicle, hold the brakes, shift to neutral, release the parking brake and slowly release the brakes until the trailer chocks absorb the load.
6. Reapply the brakes and parking brakes.
7. Shift the gear to P (Park) when the vehicle is parked on a uphill grade and in R (Reverse) on a downhill.
8. Shut off the vehicle and release the vehicle brakes but leave the parking brake set.

**WARNING**

To prevent serious or fatal injury:

- Do not get out of the vehicle without the parking brake firmly set. If you have left the engine running, the vehicle can move suddenly. You and others could be seriously or fatally injured.
- Do not apply the accelerator pedal to hold the vehicle on an uphill.

Driving the vehicle after it has been parked on a hill

1. With the gear in P (Park), apply your brakes and hold the brake pedal down while you:
 - Start your engine;
 - Shift into gear; and
 - Release the parking brake.
2. Slowly remove your foot from the brake pedal.
3. Drive slowly until the trailer is clear of the chocks.
4. Stop and have someone pick up and store the chocks.

Maintenance when towing a trailer

Your vehicle will need service more often when you regularly pull a trailer. Important items to pay particular attention to include engine oil, transmission fluid, axle lubricant and cooling system fluid. Brake condition is another important item to frequently check. If you're trailering, it's a good idea to review these items before you start your trip. Don't forget to also maintain your trailer and hitch. Follow the maintenance schedule that accompanied your trailer and check it periodically. Preferably, conduct the check at the start of each day's driving. Most importantly, all hitch nuts and bolts should be tight.

NOTICE

To prevent vehicle damage:

- **Due to higher load during trailer usage, overheating might occur on hot days or during uphill driving. If the coolant gauge indicates over-heating, switch off the air conditioner and stop the vehicle in a safe area to cool down the engine.**
- **Do not switch off the engine while the coolant gauge indicates over-heating.**
(Keep the engine idle to cool down the engine)
- **When towing check transmission fluid more frequently.**
- **If your vehicle is not equipped with an air conditioner, you should install a condenser fan to improve engine performance when towing a trailer.**

VEHICLE WEIGHT

Two labels on your driver's door sill show how much weight your vehicle was designed to carry: the Tire and Loading Information Label and the Certification Label.

Before loading your vehicle, familiarize yourself with the following terms for determining your vehicle's weight ratings, from the vehicle's specifications and the Certification Label:

Base Curb Weight

This is the weight of the vehicle including a full tank of fuel and all standard equipment. It does not include passengers, cargo, or optional equipment.

Vehicle Curb Weight

This is the weight of your new vehicle when you picked it up from your dealer plus any aftermarket equipment.

Cargo Weight

This figure includes all weight added to the Base Curb Weight, including cargo and optional equipment.

GAW (Gross Axle Weight)

This is the total weight placed on each axle (front and rear) - including vehicle curb weight and all payload.

GAWR (Gross Axle Weight Rating)

This is the maximum allowable weight that can be carried by a single axle (front or rear). These numbers are shown on the Certification Label. The total load on each axle must never exceed its GAWR.

GVW (Gross Vehicle Weight)

This is the Base Curb Weight plus actual Cargo Weight plus passengers.

GVWR (Gross Vehicle Weight Rating)

This is the maximum allowable weight of the fully loaded vehicle (including all options, equipment, passengers and cargo). The GVWR is shown on the Certification Label located on the driver's door sill.

Overloading



WARNING

The Gross Axle Weight Rating (GAWR) and the Gross Vehicle Weight Rating (GVWR) for your vehicle are on the Certification Label attached to the driver's (or front passenger's) door. Exceeding these ratings can cause an accident or vehicle damage. You can calculate the weight of your load by weighing the items (and people) before putting them in the vehicle. Be careful not to overload your vehicle.

7. Driver assistance system

Driving Safety

Forward Collision-Avoidance Assist (FCA).....	7-2
Lane Keeping Assist (LKA).....	7-26
Blind-Spot Collision-Avoidance Assist (BCA).....	7-32
Safe Exit Warning (SEW).....	7-46
Safe Exit Assist (SEA).....	7-52
Manual Speed Limit Assist (MSLA).....	7-59
Intelligent Speed Limit Assist (ISLA).....	7-62
Driver Attention Warning (DAW).....	7-67
Forward Attention Warning (FAW).....	7-73
Blind-Spot View Monitor (BVM).....	7-77

Driving Convenience

Smart Cruise Control (SCC).....	7-79
Navigation-Based Smart Cruise Control (NSCC).....	7-97
Lane Following Assist (LFA).....	7-104
Highway Driving Assist (HDA).....	7-108

Parking Safety

Rear View Monitor (RVM).....	7-120
Surround View Monitor (SVM).....	7-123
Rear Cross-Traffic Collision-Avoidance Assist (RCCA).....	7-129
Reverse Parking Distance Warning (PDW).....	7-140
Forward/Reverse Parking Distance Warning (PDW).....	7-144
Reverse Parking Collision-Avoidance Assist (PCA).....	7-149
Remote Smart Parking Assist (RSPA).....	7-157

Declaration of conformity.....	7-182
--------------------------------	-------

FORWARD COLLISION-AVOIDANCE ASSIST (FCA) (IF EQUIPPED)

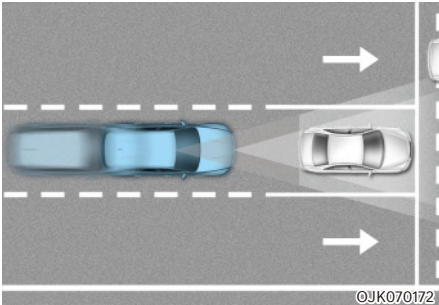

Forward Collision-Avoidance Assist is designed to help detect and monitor the vehicle ahead or help detect a pedestrian or cyclist in the roadway and warn the driver that a collision is imminent with a warning message and an audible warning, apply emergency braking.

In addition, if equipped with front corner radars, when driving at high speeds, Forward Collision-Avoidance Assist helps detect vehicles in front and adjacent lanes. If a collision is imminent when changing lanes, Forward Collision-Avoidance Assist will apply emergency braking to help prevent a collision.

Junction Turning function (if equipped)

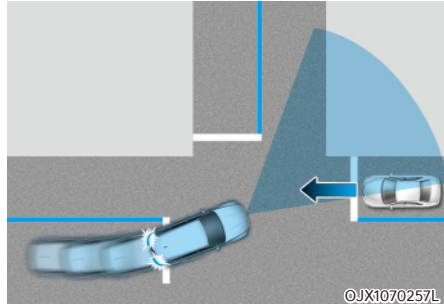

Junction Turning function helps avoid a collision with an oncoming vehicle in an adjacent lane when turning left (left-hand drive) or right (right-hand drive) at a crossroad with the turn signal on by applying emergency braking.

Junction Crossing function (if equipped)

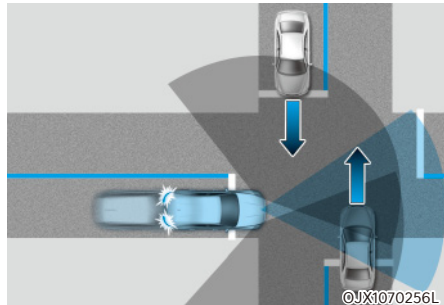

Junction Crossing function helps avoid a collision with oncoming vehicles on the left or right side when crossing an intersection by applying emergency braking.

Lane-Change Oncoming function (if equipped)

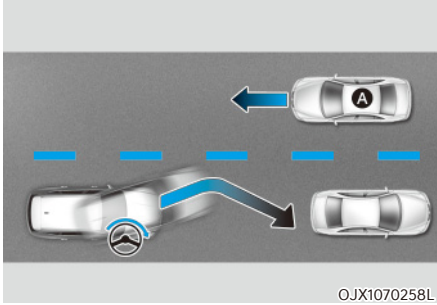

[A] : Oncoming vehicle

Lane-Change Oncoming function helps avoid a collision with an oncoming vehicle when changing lanes by assisting the driver's steering.

Lane-Change Side function (if equipped)

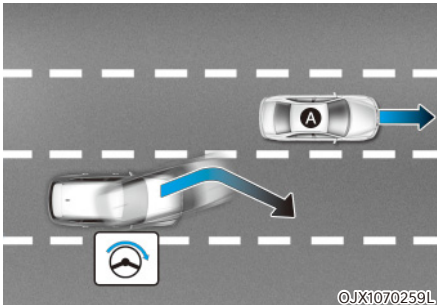

[A] : Front-side vehicle

Lane-Change Side function helps avoid a collision with the vehicle ahead in the next lane when changing lanes by assisting the driver's steering.

Evasive Steering Assist function (if equipped)

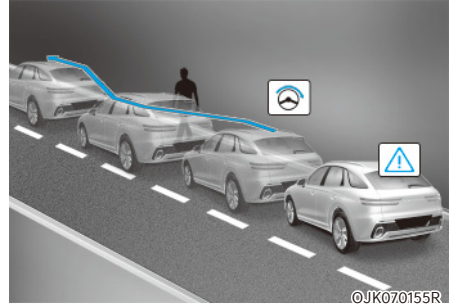

- Driver steering assist
Evasive Steering Assist function helps avoid a collision with a vehicle, pedestrian or cyclist ahead in the same lane. When a risk of collision is detected, Evasive Steering Assist function will warn the driver and if the driver steers to avoid collision it will assist the driver's steering.
- Evasive steering assist
Evasive Steering Assist function helps avoid a collision with a pedestrian or cyclist ahead in the same lane. When a risk of collision is detected, Evasive Steering Assist function will warn the driver and if there is space to avoid collision in the lane, it will assist the driver's steering.

Detecting sensor

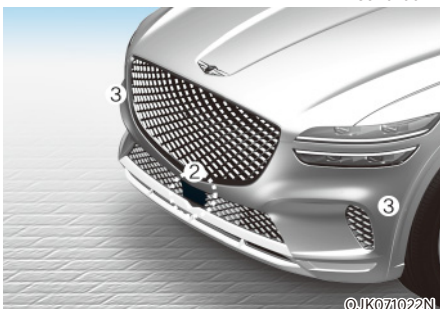
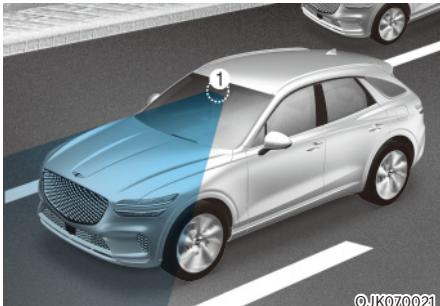

[1]: Front view camera, [2]: Front radar,
[3]: Front corner radar (if equipped),
[4]: Rear corner radar (if equipped)

Refer to the picture above for the detailed location of the detecting sensors.



CAUTION

Take the following precautions to maintain optimal performance of the detecting sensor:

- Never disassemble the detecting sensor or sensor assembly, or apply any impact on it.
- If the detecting sensors have been replaced or repaired, we recommend that you have your vehicle inspected by an authorized retailer of Genesis Branded products.
- Never install any accessories or stickers on the front windshield, or tint the front windshield.
- Pay extreme caution to keep the front view camera dry.
- Never place any reflective objects (for example, white paper, mirror) over the dashboard.
- Do not apply license plate frame or objects, such as a bumper sticker, film or a bumper guard, near the front radar cover.
- Always keep the front radar and cover clean and free of dirt and debris.

Use only a soft cloth to wash the vehicle. Do not spray pressurized water directly on the sensor or sensor cover.

- If unnecessary force has been applied to the radar or around the radar, Forward Collision-Avoidance Assist may not properly operate even though a warning message does not appear on the cluster. We recommend that the vehicle be inspected by an authorized retailer of Genesis Branded products.
- Use only genuine Genesis parts to repair or replace a damaged front radar cover. Do not apply paint to the front radar cover.
- Vehicles equipped with front corner radar and/or rear corner radar
 - Do not apply license plate frame or objects, such as a bumper sticker, film or a bumper guard, near the front corner radar or rear corner radar.
 - The function may not work properly when the bumper has been replaced, or the surroundings of the front corner radar or rear corner radar has been damaged or paint has been applied.
 - If a trailer, carrier, etc., is installed, it may adversely affect the performance of the rear corner radar or Forward Collision-Avoidance Assist may not operate properly.

Forward Collision-Avoidance Assist settings

Setting features

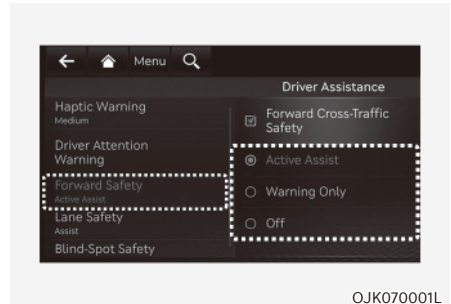

Forward Safety

With the engine on, select or deselect 'Driver Assistance → Forward Safety' from the Settings menu to set whether or not to use each function.

- If 'Active Assist' is selected, Forward Collision-Avoidance Assist will warn the driver with a warning message, an audible warning and steering wheel vibration depending on the collision risk levels. Braking assist or steering assist (if equipped) will be applied depending on the collision risk levels.
- If 'Warning Only' is selected, Forward Collision-Avoidance Assist will warn the driver with a warning message, an audible warning and steering wheel vibration depending on the collision risk levels. Braking and steering (if equipped) will not be assisted. The driver must apply the brake pedal or steer the vehicle if necessary.
- If 'Off' is selected, Forward Collision-Avoidance Assist will turn off. The  warning light illuminates on the cluster.

The driver can monitor Forward Collision-Avoidance Assist ON/OFF status from the Settings menu. If the  warning light remains ON when Forward Collision-Avoidance Assist is ON, we recommend that the vehicle be inspected by an authorized retailer of Genesis Branded products.

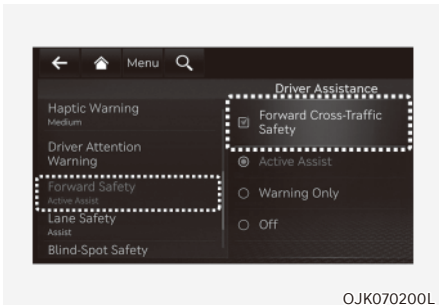

Forward Cross-Traffic Safety (if equipped)

With the engine on, select 'Driver Assistance → Forward Safety → Forward Cross-Traffic Safety' from the Settings menu to turn on Junction Crossing function and deselect to turn off the function.

WARNING

When the engine is restarted, Forward Collision-Avoidance Assist will always turn on. However, if 'Off' is selected, the driver should always be aware of the surroundings and drive safely.

CAUTION

- If 'Warning Only' is selected, braking and steering (if equipped) is not assisted.
- The settings for Forward Safety include 'Basic function', 'Junction Turning', 'Lane-Change Oncoming', 'Lane-Change Side' and 'Evasive Steering Assist' (if equipped).
- If Forward Safety is set to 'Off', Junction Crossing function will not operate even when 'Forward Cross-Traffic Safety' (if equipped) is selected.
- Steering wheel vibration can be turned on or off. Select or deselect 'Driver Assistance → Haptic Warning' from the Settings menu.

Information

Forward Collision-Avoidance Assist will turn off when ESC is turned off by pressing and holding the ESC OFF button. The  warning light will illuminate on the cluster.

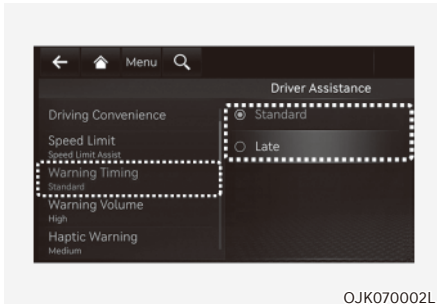

Warning Timing

With the engine on, select 'Driver Assistance → Warning Timing' from the Settings menu to change the initial warning activation time for Forward Collision-Avoidance Assist.

When the vehicle is first delivered, Warning Timing is set to 'Standard'. If you change the Warning Timing, the warning time of other Driver Assistance systems may change.

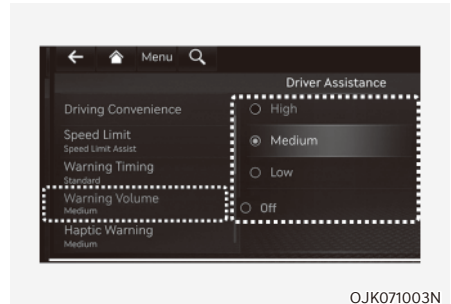

Warning Volume

With the engine on, select 'Driver Assistance → Warning Volume' or 'Sound → Driver Assist Warning → Warning Volume' from the Settings menu to change the Warning Volume to 'High', 'Medium', 'Low' or 'Off' for Forward Collision-Avoidance Assist.

However, even if 'Off' is selected, the Warning Volume of Forward Collision Avoidance Assist will not turn off, but the volume will sound as 'Low'.

If you change the Warning Volume, the warning volume of other Driver Assistance systems may change.



CAUTION

- The setting of the Warning Timing and Warning Volume applies to all functions of Forward Collision-Avoidance Assist.
- Even though 'Standard' is selected for Warning Timing, if the front vehicle suddenly stops, the warning may seem late.
- Select 'Late' for Warning Timing when traffic is light and when driving speed is slow.



Information

If the engine is restarted, Warning Timing and Warning Volume will maintain the last setting.

Forward Collision-Avoidance Assist operation

Basic function

Warning and control

The basic function for Forward Collision-Avoidance Assist is to warn and control the vehicle depending on the collision risk level: 'Collision Warning', 'Emergency Braking' and 'Stopping vehicle and ending brake control'.



Collision Warning

- To warn the driver of a collision, the 'Collision Warning' warning message will appear on the cluster, an audible warning will sound and the steering wheel will vibrate.
- If a vehicle is detected in front, the function will operate when your vehicle speed is between approximately 10~200 km/h (6~124 mph).
- If a pedestrian or cyclist is detected in front, the function will operate when your vehicle speed is between approximately 10~85 km/h (6~53 mph).
- If 'Active Assist' is selected, braking may be assisted.

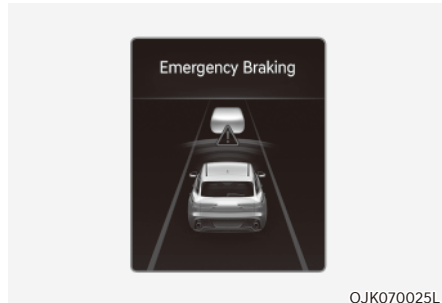

Emergency Braking

- To warn the driver that emergency braking will be assisted, the 'Emergency Braking' warning message will appear on the cluster, an audible warning will sound and the steering wheel will vibrate.
- If a vehicle is detected in front, the function will operate when your vehicle speed is between approximately 10~75 km/h (6~47 mph).
- If Forward Collision-Avoidance Assist judges that avoiding a collision is difficult even by changing the driving lane, the function will operate when your vehicle speed is between approximately 10~100 km/h (6~62 mph) (if equipped with front corner radar).
The function operation range may decrease due to the front traffic condition or the surroundings of the vehicle.
- If a pedestrian or cyclist is detected in front, the function will operate when your vehicle speed is between approximately 10~65 km/h (6~40 mph).
- In emergency braking situation, braking is assisted with strong braking power by the function to help prevent collision with the vehicle, pedestrian or cyclist ahead.



Stopping vehicle and ending brake control

- When the vehicle is stopped due to emergency braking, the 'Drive carefully' warning message will appear on the cluster.
For your safety, the driver should depress the brake pedal immediately and check the surroundings.
- Brake control will end after the vehicle is stopped by emergency braking for approximately 2 seconds.

Junction Turning function (if equipped)

Warning and control

Junction Turning function will warn and control the vehicle depending on the collision risk level: 'Collision Warning', 'Emergency Braking' and 'Stopping vehicle and ending brake control'

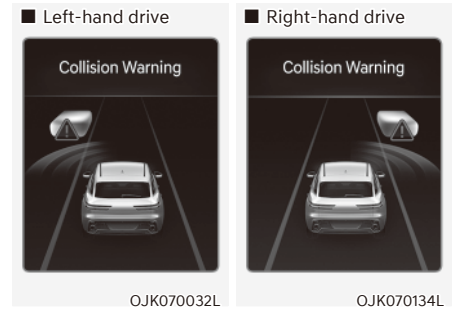

Collision Warning

- To warn the driver of a collision, the 'Collision Warning' warning message will appear on the cluster, an audible warning will sound and the steering wheel will vibrate.
- The function will operate when your vehicle speed is between approximately 10~30 km/h (6~19 mph) and the oncoming vehicle speed is between approximately 30~70 km/h (19~44 mph).
- If 'Active Assist' is selected, braking may be assisted.

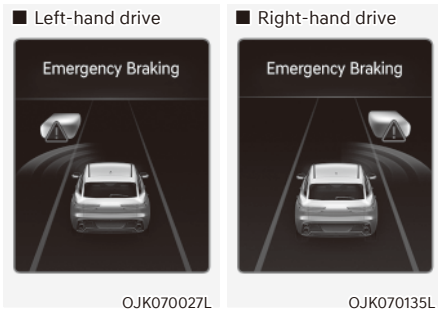

Emergency Braking

- To warn the driver that emergency braking will be assisted, the 'Emergency Braking' warning message will appear on the cluster, an audible warning will sound and the steering wheel will vibrate.
- The function will operate when your vehicle speed is between approximately 10~30 km/h (6~19 mph) and the oncoming vehicle speed is between approximately 30~70 km/h (19~44 mph).
- In emergency braking situation, braking is assisted with strong braking power by the function to help prevent collision with the oncoming vehicle.

Stopping vehicle and ending brake control

- When the vehicle is stopped due to emergency braking, the 'Drive carefully' warning message will appear on the cluster.
For your safety, the driver should depress the brake pedal immediately and check the surroundings.
- Brake control will end after the vehicle is stopped by emergency braking for approximately 2 seconds.

Information

If the driver's seat is on the left side, Junction Turning function will operate only when the driver turns left. If the driver's seat position is on right side, the function will operate only when you turn right.

Junction Crossing function (if equipped)

Warning and control

Junction Crossing function will warn and control the vehicle depending on collision risk level: 'Collision Warning', 'Emergency Braking' and 'Stopping vehicle and ending brake control'

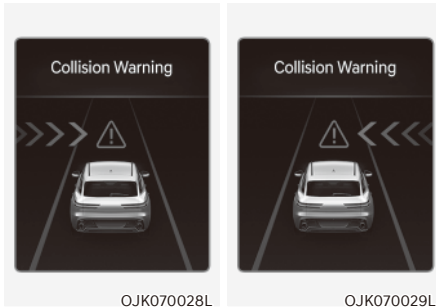

Collision Warning

- To warn the driver of a collision, the 'Collision Warning' warning message will appear on the cluster, an audible warning will sound and the steering wheel will vibrate.
- The function will operate when your vehicle speed is between approximately 10~30 km/h (6~19 mph) and the crossing vehicle speed is between approximately 10~60 km/h (6~37 mph).
- If 'Active Assist' and 'Forward Cross-Traffic Safety' are selected, braking may be assisted.

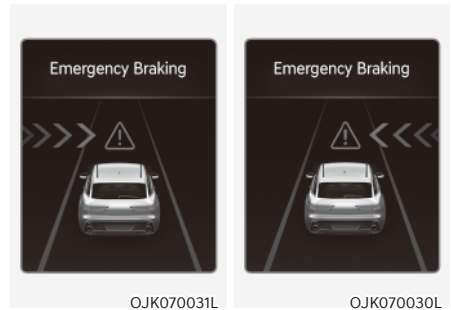

Emergency Braking

- To warn the driver that emergency braking will be assisted, the 'Emergency Braking' warning message will appear on the cluster, an audible warning will sound and the steering wheel will vibrate.
- The function will operate when your vehicle speed is between approximately 10~30 km/h (6~19 mph) and the crossing vehicle speed is between approximately 10~20 km/h (6~12 mph).
- In emergency braking situation, braking is assisted with strong braking power by the function to help prevent collision with the crossing vehicle.

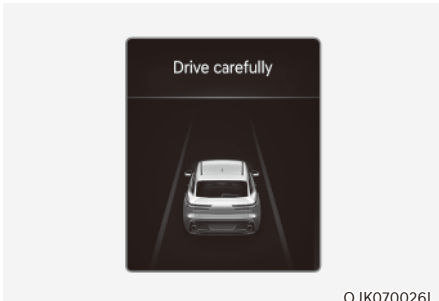

OJK070026L

Stopping vehicle and ending brake control

- When the vehicle is stopped due to emergency braking, the 'Drive carefully' warning message will appear on the cluster.
For your safety, the driver should depress the brake pedal immediately and check the surroundings.
- Brake control will end after the vehicle is stopped by emergency braking for approximately 2 seconds.

CAUTION

If the collision angle with the crossing vehicle is beyond a certain range, Junction Crossing function warning and control may be late or may not operate.

Lane-Change Oncoming function (if equipped)

Warning and control

Lane-Change Oncoming function will warn and control the vehicle depending on collision risk level: 'Collision Warning' and 'Emergency Steering'

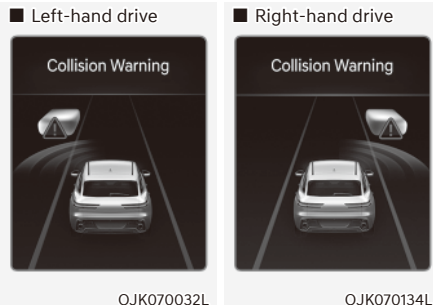

Collision Warning

- To warn the driver of a collision, the 'Collision Warning' warning message will appear on the cluster, an audible warning will sound and the steering wheel will vibrate.
- The function will operate when your vehicle speed is between approximately 40~145 km/h (25~90 mph) and the oncoming vehicle speed is approximately above 10 km/h (6 mph) and the relative speed with your vehicle is approximately below 200 km/h (124 mph).



Emergency Steering

- To warn the driver that emergency steering will be assisted, the 'Emergency Steering' warning message will appear on the cluster, an audible warning will sound and the steering wheel will vibrate.
- The function will operate when your vehicle speed is between approximately 40~145 km/h (25~90 mph) and the oncoming vehicle speed is approximately above 10 km/h (6 mph) and the relative speed with your vehicle is approximately below 200 km/h (124 mph).
- In emergency steering situation, steering is assisted by the function to help prevent collision with the oncoming vehicle.

Lane-Change Side function (if equipped)

Warning and control

Lane-Change Side function will warn and control the vehicle depending on collision risk level: 'Collision Warning' and 'Emergency Steering'

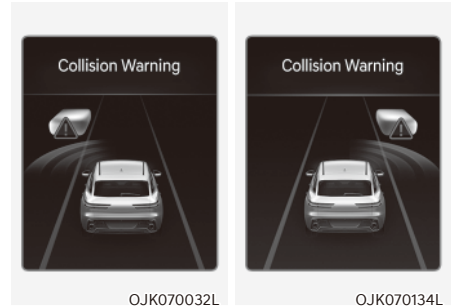

Collision Warning

- To warn the driver of a collision, the 'Collision Warning' warning message will appear on the cluster, an audible warning will sound and the steering wheel will vibrate.
- The function will operate when your vehicle speed is between approximately 40~145 km/h (25~90 mph).



Emergency Steering

- To warn the driver that emergency steering will be assisted, the 'Emergency Steering' warning message will appear on the cluster, an audible warning will sound and the steering wheel will vibrate.
- The function will operate when your vehicle speed is between approximately 40~145 km/h (25~90 mph).
- In emergency steering situation, steering is assisted by the function to help prevent collision with the front-side vehicle.

CAUTION

Lane-Change Side function does not operate if the vehicle speed of the oncoming vehicle from the front side is 0 km/h (0 mph).

Evasive Steering Assist function (if equipped)

Warning and control

Evasive Steering Assist function will warn and control the vehicle with 'Emergency steering'.



Emergency Steering (Driver steering assist)

- To warn the driver that emergency steering will be assisted, the 'Emergency Steering' message will appear on the cluster, an audible warning will sound and the steering wheel will vibrate.
- The function will operate when your vehicle speed is between approximately 40~85 km/h (25~53 mph).
- If there is a risk of collision with a vehicle, pedestrian and cyclist in front, the steering will be assisted to help prevent collision when the driver steers the vehicle to avoid collision.



Emergency Steering (Evasive steering assist)

- To warn the driver that emergency steering will be assisted, the 'Emergency Steering' message will appear on the cluster, an audible warning will sound and the steering wheel will vibrate.
- The function will operate when your vehicle speed is between approximately 65~75 km/h (40~47 mph).
- If there is high risk of collision with a pedestrian and cyclist in front, and the vehicle speed to operate emergency braking is within the operation range, the steering will be assisted to help prevent collision when there is space to avoid collision in the driving lane.



CAUTION

- The steering wheel may turn automatically when emergency steering is operating.
- Emergency steering will automatically cancel when risk factors disappear. If necessary, the driver must steer the vehicle.
- Emergency steering may not operate or may cancel during operation if the steering wheel is held tight or steered in the opposite direction.
- When steering is assisted to avoid collision with a vehicle, pedestrian and cyclist, Evasive steering assist will be canceled if collisions with other objects (vehicles, pedestrians, or cyclists) are expected.
- Evasive steering assist may not operate if space to avoid collision in the driving lane is insufficient.



Information

For more details on warning messages, refer to Collision Warning in "Basic Function".



WARNING

Take the following precautions when using Forward Collision-Avoidance Assist:

- For your safety, change the Settings after parking the vehicle at a safe location.
- With 'Active Assist' or 'Warning Only' selected, when ESC is turned off by pressing and holding the ESC OFF button for more than 3 seconds, Forward Collision-Avoidance Assist will turn off automatically. In this case, Forward Collision-Avoidance Assist cannot be set from the Settings menu and the  warning light will illuminate on the cluster which is normal. If ESC is turned on by pressing the ESC OFF button, Forward Collision-Avoidance Assist will maintain the last setting.
- Forward Collision-Avoidance Assist does not operate in all situations or cannot avoid all collisions.
- The driver should hold the responsibility to control the vehicle. Do not solely depend on Forward Collision-Avoidance Assist. Rather, maintain a safe braking distance, and if necessary, depress the brake pedal to reduce driving speed or to stop the vehicle.
- Never deliberately operate Forward Collision-Avoidance Assist on people, objects, etc. It may cause serious injury or death.
- Forward Collision-Avoidance Assist may not operate if the driver depresses the brake pedal to avoid collision.

- Depending on the road and driving conditions, Forward Collision-Avoidance Assist may warn the driver late or may not warn the driver.
- During Forward Collision-Avoidance Assist operation, the vehicle may stop suddenly injuring passengers and shifting loose objects. Always have the seat belt on and keep loose objects secured.
- If any other system's warning message is displayed or audible warning is generated, Forward Collision-Avoidance Assist warning message may not be displayed and audible warning may not be generated.
- You may not hear the warning sound of Forward Collision-Avoidance Assist if the surrounding is noisy.
- Forward Collision-Avoidance Assist may turn off or may not operate properly or may operate unnecessarily depending on the road conditions and the surroundings.



WARNING

- Even if there is a problem with Forward Collision-Avoidance Assist, the vehicle's basic braking performance will operate normally.
- During emergency braking, braking control by Forward Collision-Avoidance Assist will automatically cancel when the driver excessively depresses the accelerator pedal or sharply steers the vehicle.



CAUTION

- Depending on the condition of the vehicle, pedestrian and cyclist in front and the surroundings, the speed range to operate Forward Collision-Avoidance Assist may reduce. Forward Collision-Avoidance Assist may only warn the driver, or it may not operate.
- Forward Collision-Avoidance Assist will operate under certain conditions by judging the risk level based on the condition of the oncoming vehicle, driving direction, speed and surroundings.
- When a collision with a surrounding vehicle is expected, Lane-Change Oncoming, Lane-Change Side and Evasive Steering Assist functions will only warn the driver (if equipped).





Information

In a situation where collision is imminent, braking may be assisted by Forward Collision-Avoidance Assist when braking is insufficient by the driver.

Forward Collision-Avoidance Assist malfunction and limitations

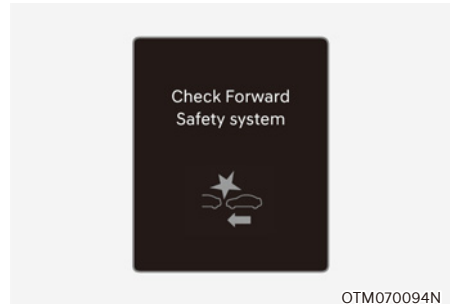
Forward Collision-Avoidance Assist malfunction



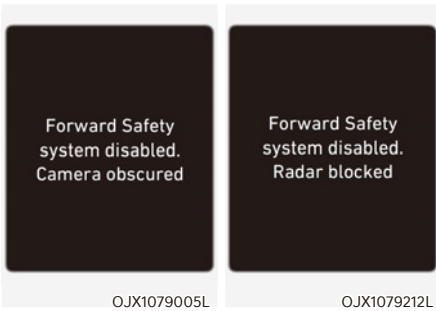

When Forward Collision-Avoidance Assist is not working properly, the 'Check Forward Safety' warning message will appear, and the  and  warning lights will illuminate on the cluster. We recommend that the vehicle be inspected by an authorized retailer of Genesis Branded products.

Forward Collision-Avoidance Assist disabled



When the front windshield where the front view camera is located, front radar cover, bumper or sensor is covered with foreign material, such as snow or rain, it can reduce the detecting performance and temporarily limit or disable Forward Collision-Avoidance Assist.

If this occurs the 'Forward Safety system disabled. Camera obscured' or the 'Forward Safety system disabled. Radar blocked' warning message, and the  and  warning lights will illuminate on the cluster.

Forward Collision-Avoidance Assist will operate normally when snow, rain or foreign material is removed.

If Forward Collision-Avoidance Assist does not operate normally after obstruction (snow, rain, or foreign material) is removed (including trailer, carrier, etc., from the rear bumper), we recommend that the vehicle be inspected by an authorized retailer of Genesis Branded products.

WARNING

- Even though the warning message or warning light does not appear on the cluster, Forward Collision-Avoidance Assist may not properly operate.
- Forward Collision-Avoidance Assist may not properly operate in an area (for example, open terrain), where any substance are not detected after turning ON the engine.

Limitations of Forward Collision-Avoidance Assist

Forward Collision-Avoidance Assist may not operate normally, or it may operate unexpectedly under the following circumstances:

- The detecting sensor or the surroundings are contaminated or damaged
- The temperature around the front view camera is high or low
- The camera lens is contaminated due to tinted, filmed or coated windshield, damaged glass, or sticky foreign material (sticker, bug, etc.) on the glass
- Moisture is not removed or frozen on the windshield
- Washer fluid is continuously sprayed, or the wiper is on
- Driving in heavy rain or snow, or thick fog
- The field of view of the front view camera is obstructed by sun glare
- Street light or light from an oncoming vehicle is reflected on the wet road surface, such as a puddle on the road
- An object is placed on the dashboard

- Your vehicle is being towed
- The surrounding is very bright
- The surrounding is very dark, such as in a tunnel, etc.
- The brightness changes suddenly, for example when entering or exiting a tunnel
- The brightness outside is low, and the headlamps are not on or are not bright
- Driving through steam, smoke or shadow
- Only part of the vehicle, pedestrian or cyclist is detected
- The vehicle in front is a bus, heavy truck, truck with a unusually shaped luggage, trailer, etc.
- The vehicle in front has no tail lights, tail lights are located unusually, etc.
- The brightness outside is low, and the tail lamps are not on or are not bright
- The rear of the front vehicle is small or the vehicle does not look normal, such as when the vehicle is tilted, overturned, or the side of the vehicle is visible, etc.
- The front vehicle's ground clearance is low or high
- A vehicle, pedestrian or cyclist suddenly cuts in front
- The bumper around the front radar is impacted, damaged or the front radar is out of position
- The temperature around the front radar is high or low
- Driving through a tunnel or iron bridge
- Driving in vast areas where there are few vehicles or structures (for example, desert, meadow, suburb, etc.)
- Driving near areas containing metal substances, such as a construction zone, railroad, etc.
- A material is near that reflects very well on the front radar, such as a guardrail, nearby vehicle, etc.
- The cyclist in front is on a bicycle made of material that does not reflect on the front radar
- The vehicle in front is detected late
- The vehicle in front is suddenly blocked by an obstacle
- The vehicle in front suddenly changes lane or suddenly reduces speed
- The vehicle in front is bent out of shape
- The front vehicle's speed is fast or slow
- The vehicle in front steers in the opposite direction of your vehicle to avoid a collision
- With a vehicle in front, your vehicle changes lane at low speed
- The vehicle in front is covered with snow
- You are departing or returning to the lane
- Unstable driving
- You are on a roundabout and the vehicle in front is not detected
- You are continuously driving in a circle
- The vehicle in front has an unusual shape
- The vehicle in front is driving uphill or downhill
- The pedestrian or cyclist is not fully detected, for example, if the pedestrian is leaning over or is not fully walking upright
- The pedestrian or cyclist is wearing clothing or equipment that makes it difficult to detect

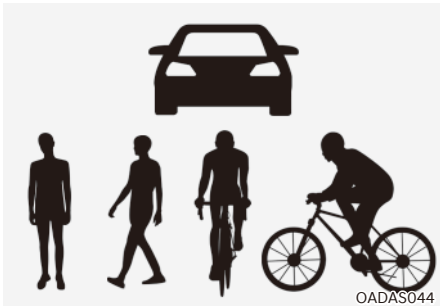

The illustration above shows the image the front view camera and front radar will detect as a vehicle, pedestrian and cyclist.

- The pedestrian or cyclist in front is moving very quickly
 - The pedestrian or cyclist in front is short or is posing a low posture
 - The pedestrian or cyclist in front has impaired mobility
 - The pedestrian or cyclist in front is moving intersected with the driving direction
 - There is a group of pedestrians, cyclists or a large crowd in front
 - The pedestrian or cyclist is wearing clothing that easily blends into the background, making it difficult to detect
 - The pedestrian or cyclist is difficult to distinguish from the similar shaped structure in the surroundings
- You are driving by a pedestrian, cyclist, traffic signs, structures, etc., near the intersection
 - Driving in a parking lot
 - Driving through a tollgate, construction area, unpaved road, partial paved road, uneven road, speed bumps, etc.
 - Driving on an incline road, curved road, etc.
 - Driving through a roadside with trees or streetlights
 - The adverse road conditions cause excessive vehicle vibrations while driving
 - Your vehicle height is low or high due to heavy loads, abnormal tire pressure, etc.
 - Driving through a narrow road where trees or grass are overgrown
 - There is interference by electromagnetic waves, such as driving in an area with strong radio waves or electrical noise

Junction Crossing, Lane-Change Oncoming, Lane-Change Side, Evasive Steering Assist function (if equipped)

- The temperature around the front corner radar or rear corner radar is high or low
- A trailer or carrier is installed around the rear corner radar
- The front corner radar or rear corner radar is covered with snow, rain, dirt, etc.
- The bumper around the front corner radar or rear corner radar is covered with objects, such as a bumper sticker, bumper guard, bike rack, etc.
- The bumper around the front corner radar or rear corner radar is impacted, damaged or the radar is out of position
- The front corner radar or rear corner radar is blocked by other vehicles, walls or pillars
- Driving on a highway (or motorway) ramp
- Driving on a road where the guardrail or wall is in double structure
- The other vehicle drives very close behind your vehicle, or the other vehicle passes by your vehicle in close proximity
- The speed of the other vehicle is very fast that it passes by your vehicle in a short time
- Your vehicle passes by the other vehicle
- Your vehicle has started at the same time as the vehicle next to you and has accelerated
- The vehicle in the next lane moves two lanes away from you, or when the vehicle two lanes away moves to the next lane from you
- A motorcycle or bicycle is detected
- A vehicle such as a flat trailer is detected
- A big vehicle such as a bus or truck is detected
- A small moving obstacle such as a pedestrian, animal, shopping cart or a baby stroller is detected
- A vehicle with low height such as a sports car is detected
- The lane is difficult to see due to foreign material, such as rain, snow, dust, sand, oil and water puddles
- The color of the lane marking is not distinguishable from the road

- There are markings on the road near the lane or the markings on the road looks similar to the lane markings
- The shadow is on the lane marking by a median strip, trees, guardrail, noise barriers, etc.
- The lane number increases or decreases, or the lane markings are crossing
- There are more than two lane markings on the road
- The lane markings are complicated or a structure substitutes for the lines, such as a construction area
- There are road markings, such as zigzag lanes, crosswalk markings and road signs
- The lane suddenly disappears, such as at the intersection
- The lane is very wide or narrow
- There is a curb or road edges without a lane
- The vehicle in front is driving with one side on the lane marking
- The distance to the front vehicle is extremely short



WARNING

- **Driving on a curved road**

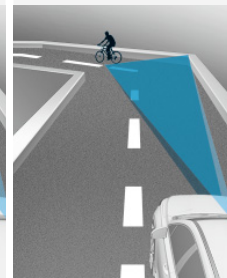
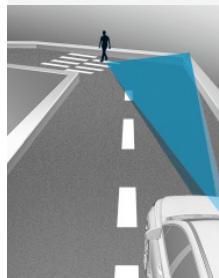
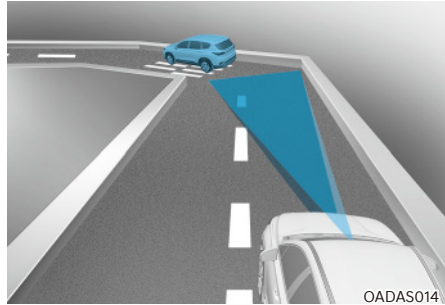

Forward Collision-Avoidance Assist may not detect other vehicles, pedestrians or cyclists in front of you while driving on curved roads adversely affecting the performance of the sensors. This may result in no warning, braking assist or steering assist (if equipped) when necessary.

When driving on a curved road, you must maintain a safe braking distance, and if necessary, steer the vehicle and depress the brake pedal to reduce your driving speed in order to maintain a safe distance.

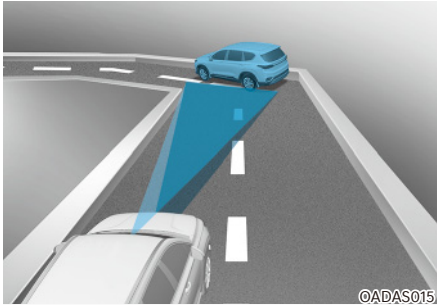

OADAS015

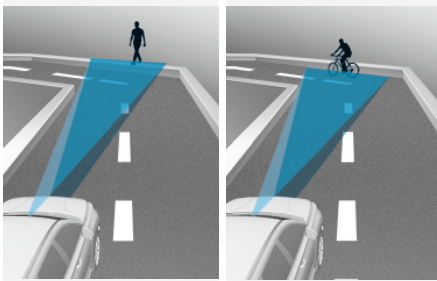

OADAS017

OADAS019

Forward Collision-Avoidance Assist may detect a vehicle, pedestrian or cyclist in the next lane or outside the lane when driving on a curved road. If this occurs, Forward Collision-Avoidance Assist may unnecessarily warn the driver and control the brake or steering wheel (if equipped). Always check the traffic conditions around the vehicle.

- **Driving on an inclined road**

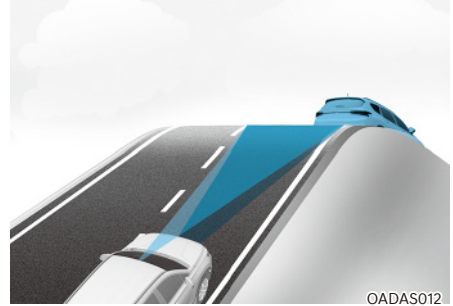

OADAS012

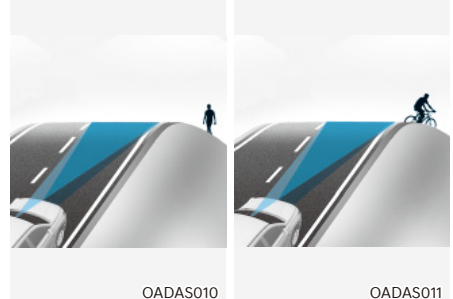

OADAS010

OADAS011

Forward Collision-Avoidance Assist may not detect other vehicles, pedestrians or cyclists in front of you while driving uphill or downhill, adversely affecting the performance of the sensors.

This may result in unnecessary warning, braking assist or steering assist (if equipped) or no warning, braking assist or steering assist (if equipped) when necessary.

Also, vehicle speed may rapidly decrease when a vehicle, pedestrian or cyclist ahead is suddenly detected.

Always have your eyes on the road while driving uphill or downhill and if necessary, steer your vehicle and depress the brake pedal to reduce your driving speed in order to maintain a safe distance.

- Changing lanes

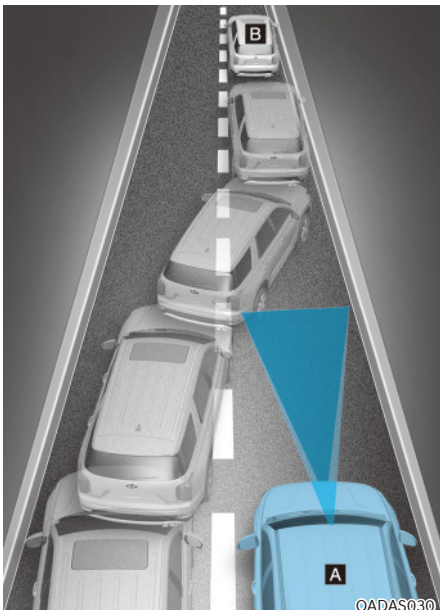

[A] : Your vehicle, [B] : Lane changing vehicle

When a vehicle moves into your lane from an adjacent lane, it cannot be detected by the sensor until it is in the sensor's detection range. Forward Collision-Avoidance Assist may not immediately detect the vehicle when the vehicle changes lanes abruptly. In this case, you must maintain a safe braking distance, and if necessary, steer your vehicle and depress the brake pedal to reduce your driving speed in order to maintain a safe distance.

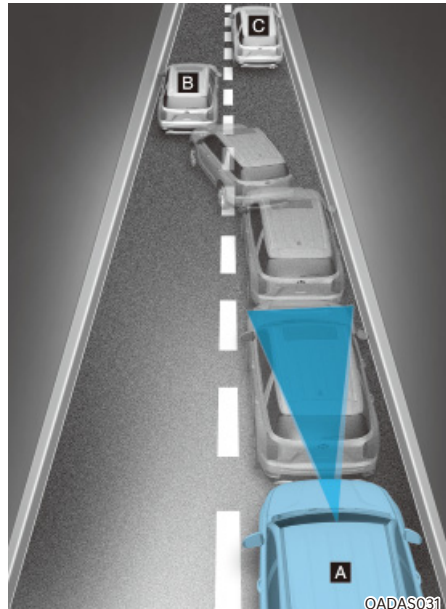

[A] : Your vehicle, [B] : Lane changing vehicle,
[C] : Same lane vehicle

When a vehicle in front of you merges out of the lane, Forward Collision-Avoidance Assist may not immediately detect the vehicle that is now in front of you. In this case, you must maintain a safe braking distance, and if necessary, steer your vehicle and depress the brake pedal to reduce your driving speed in order to maintain a safe distance.

- Detecting vehicle

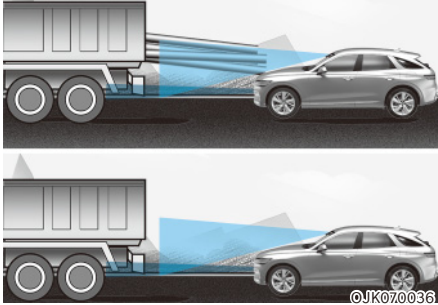

If the vehicle in front of you has cargo that extends rearward from the cab, or when the vehicle in front of you has higher ground clearance, additional special attention is required. Forward Collision-Avoidance Assist may not be able to detect the cargo extending from the vehicle. In these instances, you must maintain a safe braking distance from the rearmost object, and if necessary, steer your vehicle and depress the brake pedal to reduce your driving speed in order to maintain distance.



WARNING

- When you are towing a trailer or another vehicle, turn off Forward Collision-Avoidance Assist for safety reasons.
- Forward Collision-Avoidance Assist may operate if objects that are similar in shape or characteristics to vehicles, pedestrians and cyclists are detected.
- Forward Collision-Avoidance Assist does not operate on bicycles, motorcycles, or smaller wheeled objects, such as luggage bags, shopping carts, or strollers.
- Forward Collision-Avoidance Assist may not operate normally if interfered by strong electromagnetic waves.
- Forward Collision-Avoidance Assist may not operate for 15 seconds after the vehicle is started, or the front view camera is initialized.

LANE KEEPING ASSIST (LKA) (IF EQUIPPED)

Lane Keeping Assist is designed to help detect lane markings (or road edges) while driving over a certain speed. Lane Keeping Assist will warn the driver if the vehicle leaves the lane without using the turn signal, or will automatically assist the driver's steering to help prevent the vehicle from departing the lane.

Detecting sensor



[1] : Front view camera

The front view camera is used as a detecting sensor to detect lane markings (or road edges).

Refer to the picture above for the detailed location of the detecting sensor.

CAUTION

For more details on the precautions of the front view camera, refer to “Forward Collision-Avoidance Assist (FCA)” section in this chapter.

Lane Keeping Assist settings

Setting features

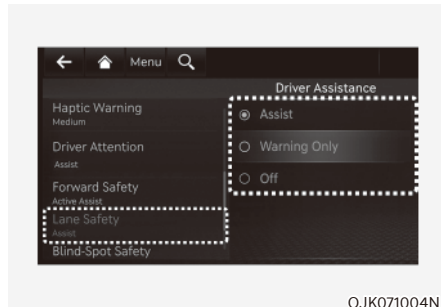

Lane Safety

With the engine on, select or deselect ‘Driver Assistance → Lane Safety’ from the Settings menu to set whether to use each function.



- If ‘Assist’ is selected, Lane Keeping Assist will automatically assist the driver’s steering when lane departure is detected to help prevent the vehicle from moving out of its lane.
- If ‘Warning Only’ is selected, Lane Keeping Assist will warn the driver with an audible warning and steering wheel vibration when lane departure is detected. The driver must steer the vehicle.
- If ‘Off’ is selected, Lane Keeping Assist will turn off. The  indicator light will turn off on the cluster.

WARNING

- If ‘Warning Only’ is selected, steering is not assisted.
- Lane Keeping Assist does not control the steering wheel when the vehicle is driven in the middle of the lane.
- The driver should always be aware of the surroundings and steer the vehicle if ‘Off’ is selected.

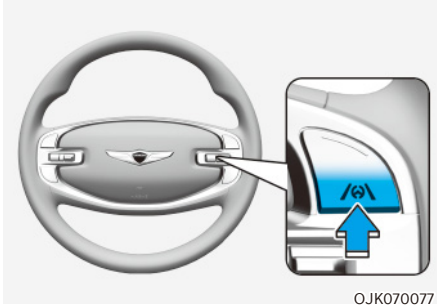
Turning Lane Keeping Assist On/Off



- Except Europe, Australia, Russia
With the engine on, press and hold the Lane Driving Assist button located on the steering wheel to turn on Lane Keeping Assist. The grey  indicator light will illuminate on the cluster.
Press and hold the button again to turn off the function.
If the engine is restarted, Lane Keeping Assist will maintain the last setting.
- For Europe, Australia, Russia
Whenever the engine is turned on, Lane Keeping Assist will always turn on. The grey  indicator light will illuminate on the cluster.
When Lane Keeping Assist is on, press and hold the Lane Driving Assist button to turn off the function.

Information

When the Lane Driving Assist button is pressed shortly, Lane Following Assist will turn on and off.

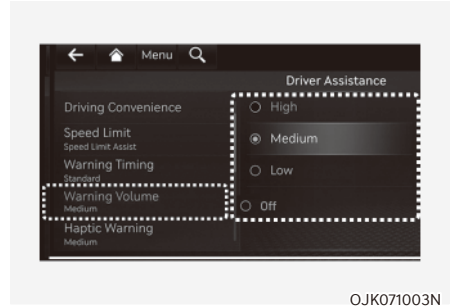

Warning Volume

With the engine on, select 'Driver Assistance → Warning volume' or 'Sound → Driver Assist Warning → Warning Volume' from the Settings menu to change the Warning Volume to 'High', 'Medium', 'Low' or 'Off' for Lane Keeping Assist.

However, even if 'Off' is selected, the Hands-off Warning Volume will not turn off. Steering wheel vibration function will also remain on even if 'Off' is selected.

If you change the Warning Volume, the warning volume of other Driver Assistance systems may change.

Lane Keeping Assist operation

Warning and control

Lane Keeping Assist will warn and help control the vehicle with Lane Departure Warning and Lane Keeping Assist.



Lane Departure Warning

- To warn the driver that the vehicle is departing from the projected lane in front, the green  indicator light will blink on the cluster, the lane line will blink on the cluster depending on which direction the vehicle is veering, and an audible warning will sound. Also, the steering wheel will vibrate.
- Lane Keeping Assist will operate when your vehicle speed is between approximately 60~200 km/h (40~120 mph).

Lane Keeping Assist

- To warn the driver that the vehicle is departing from the projected lane in front, the green  indicator light will blink on the cluster, and the steering wheel will make adjustments to keep vehicle inside the lane.
- Lane Keeping Assist will operate when your vehicle speed is between approximately 60~200 km/h (40~120 mph).

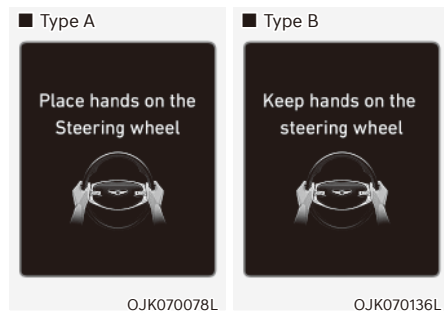

Hands-off warning

If the driver takes their hands off the steering wheel for several seconds, the 'Place hands on the steering wheel' (or 'Keep hands on the steering wheel') warning message will appear on the cluster, and an audible warning will sound in stages.



WARNING

- The steering wheel may not be assisted if the steering wheel is held very tight or the steering wheel is steered over a certain degree.
- Lane Keeping Assist does not operate at all times. It is the responsibility of the driver to safely steer the vehicle and to maintain the vehicle in its lane.
- The hands-off warning message may appear late depending on road conditions. Always have your hands on the steering wheel while driving.
- If the steering wheel is held very lightly, the hands-off warning message may appear because Lane Keeping Assist may not recognize that the driver has their hands on the steering wheel.
- If you attach objects to the steering wheel, the hands-off warning may not work properly.



Information

- For more details on setting the functions in the infotainment system, refer to “Vehicle Settings” section in chapter 4.
- When lane markings (or road edges) are detected, the lane lines on the cluster will change from grey to white and the green  indicator light will illuminate.

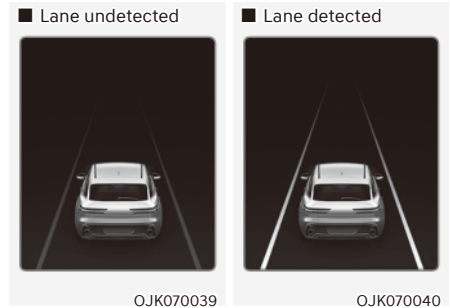

- Even though the steering is assisted by Lane Keeping Assist, the driver may control the steering wheel.
- The steering wheel may feel heavier or lighter when the steering wheel is assisted by Lane Keeping Assist than when it is not.

Lane Keeping Assist malfunction and limitations

Lane Keeping Assist malfunction



When Lane Keeping Assist is not working properly, the ‘Check Lane Keeping Assist (LKA) system’ (or ‘Check LKA (Lane Keeping Assist) system’) warning message will appear and the yellow  indicator light will illuminate on the cluster. If this occurs, we recommend that the vehicle be inspected by an authorized retailer of Genesis Branded products.

Limitations of Lane Keeping Assist

Lane Keeping Assist may not operate normally or may operate unexpectedly under the following circumstances:

- The lane is contaminated or difficult to distinguish because,
 - The lane markings (or road edge) is covered with rain, snow, dirt, oil, etc.
 - The color of the lane marking (or road edge) is not distinguishable from the road

- There are markings (or road edges) on the road near the lane or the markings (or road edges) on the road looks similar to the lane markings (or road edge)
- The lane marking (or road edge) is indistinct or damaged
- The shadow is on the lane marking (or road edge) by a median strip, trees, guardrail, noise barriers, etc.
- The lane number increases or decreases, or the lane markings (or road edges) are crossing
- There are more than two lane markings (or road edges) on the road
- The lane markings (or road edges) are complicated or a structure substitutes for the lines, such as a construction area
- There are road markings, such as zigzag lanes, crosswalk markings and road signs
- The lane suddenly disappears, such as at the intersection
- The lane (or road width) is very wide or narrow
- There is a road edge without a lane
- There is a boundary structure in the roadway, such as a tollgate, sidewalk, curb, etc.
- The distance to the front vehicle is extremely short or the vehicle in front is covering the lane marking (or road edge)

Information

For more details on the limitations of the front view camera, refer to “Forward Collision-Avoidance Assist (FCA)” section in this chapter.



WARNING

Take the following precautions when using Lane Keeping Assist:

- The driver should hold the responsibility to safely drive and control the vehicle. Do not solely rely on Lane Keeping Assist and drive dangerously.
 - The operation of Lane Keeping Assist can be cancelled or not work properly depending on road conditions and surroundings. Always be cautious while driving.
 - Refer to “Limitations of Lane Keeping Assist” if the lane is not detected properly.
 - When you are towing a trailer or another vehicle, turn off Lane Keeping Assist for safety reasons.
 - If the vehicle is driven at high speed, the steering wheel will not be controlled. The driver must always follow the speed limit when using Lane Keeping Assist.
 - If any other system’s warning message is displayed or audible warning is generated, Lane Keeping Assist warning message may not be displayed and audible warning may not be generated.
- You may not hear the warning sound of Lane Keeping Assist if the surrounding is noisy.
 - If you attach objects to the steering wheel, steering may not be assisted properly.
 - Lane Keeping Assist may not operate for 15 seconds after the vehicle is started, or the front view camera is initialized.
 - Lane Keeping Assist will not operate when:
 - The turn signal or hazard warning flasher is turned on.
 - The vehicle is not driven in the center of the lane when Lane Keeping Assist is turned on or right after changing a lane.
 - ESC (Electronic Stability Control) or VSM (Vehicle Stability Management) is activated.
 - The vehicle is driven on a sharp curve.
 - Vehicle speed is below 55 km/h (35 mph) or above 210 km/h (130 mph).
 - The vehicle makes sharp lane changes.
 - The vehicle brakes suddenly.

BLIND-SPOT COLLISION-AVOIDANCE ASSIST (BCA) (IF EQUIPPED)

Blind-Spot Collision-Avoidance Assist is designed to help detect and monitor approaching vehicles in the driver's blind spot area and warn the driver of a possible collision with a warning message and audible warning.

In addition, if there is a risk of collision when changing lanes or driving forward out of a parking space, Blind-Spot Collision-Avoidance Assist will help avoid collision by applying the brake.

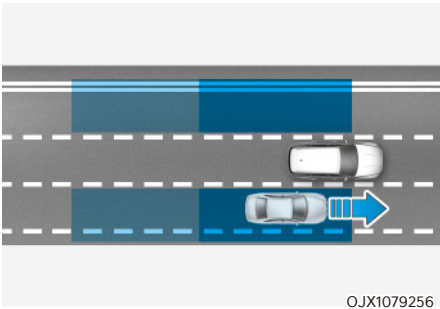

Blind-Spot Collision-Avoidance Assist helps detect and informs the driver that a vehicle is in the blind spot.

CAUTION

The detecting range may vary depending on the speed of your vehicle. However, even if there is a vehicle in the blind spot area, Blind-Spot Collision-Avoidance Assist may not warn you when you pass by at high speeds.

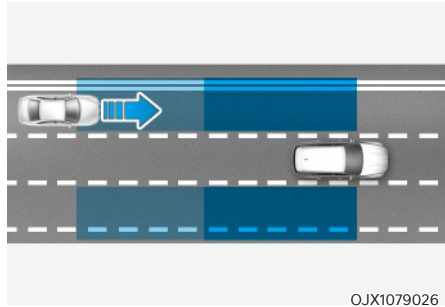

Blind-Spot Collision-Avoidance Assist helps detect and informs the driver that a vehicle is approaching at high speed from the blind spot area.

CAUTION

Warning timing may vary depending on the speed of the vehicle approaching at high speed.

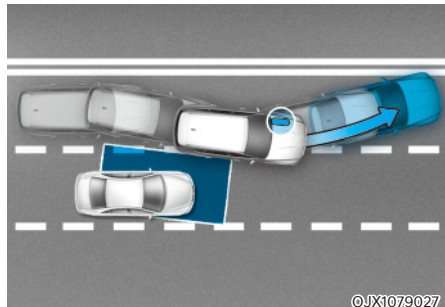

When changing lanes by detecting the lane ahead, if Blind-Spot Collision-Avoidance Assist judges that there is a collision risk with an approaching vehicle in the blind spot, it will help avoid collision by applying the brake.

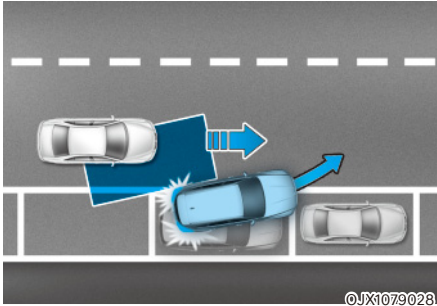

©JX1079028

When you are driving forward out of a parking space, if Blind-Spot Collision-Avoidance Assist judges that there is a collision risk with an approaching vehicle in the blind spot, it helps avoid collision by applying the brake.



Information

In the following text, Blind-Spot Collision-Avoidance Assist will be referred as Blind-Spot Safety system.

Detecting sensor



©JK071223N



©JK1071248L

[1] : Front view camera, [2] : Rear corner radar

Refer to the picture above for the detailed location of the detecting sensors.



CAUTION

Take the following precautions to maintain optimal performance of the detecting sensor:

- Never disassemble the rear corner radar or radar assembly, or apply any impact on it.
- If there is impact on the rear corner radar or near the radar, even though the warning message does not appear on the cluster, Blind-Spot Safety system may not operate properly. We recommend that the vehicle be inspected by an authorized retailer of Genesis Branded products.

- If the rear corner radars have been replaced or repaired, we recommend that the vehicle be inspected by an authorized retailer of Genesis Branded products.
- Use only genuine Genesis parts to repair the rear bumper where the rear corner radar is located.
- Do not apply license plate frame or objects, such as a bumper sticker, film or a bumper guard near the rear corner radar.
- The system may not work properly if the bumper has been replaced, or the surroundings of the rear corner radar has been damaged or paint has been applied.
- If a trailer, carrier, etc., is installed, it may adversely affect the performance of the rear corner radar or the system may not operate.
- For more details on the precautions of the front view camera, refer to “Forward Collision-Avoidance Assist (FCA)” section in this chapter.

Blind-Spot Safety system settings

Setting features

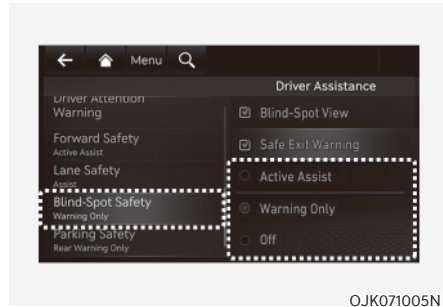

Blind-Spot Safety

With the engine on, select or deselect 'Driver Assistance → Blind-Spot Safety' from the Settings menu to set whether or not to use each function.

- If 'Active Assist' is selected, the system will warn the driver with a warning message, an audible warning and steering wheel vibration depending on the collision risk levels. Braking assist will be applied depending on the collision risk levels.
- If 'Warning Only' is selected, the system will warn the driver with a warning message, an audible warning and steering wheel vibration depending on the collision risk levels. Braking will not be assisted.
- If 'Off' is selected, the system will turn off.



OTM070097N

When the engine is restarted with the system off, the 'Blind-Spot Safety System is Off' message will appear on the cluster.

If you change the setting from 'Off' to 'Active Assist' or 'Warning Only', the warning light on the outside rearview mirror will blink for three seconds.

In addition, if the engine is turned on, when the system is set to 'Active Assist' or 'Warning Only', the warning light on the outside rearview mirror will blink for three seconds.



WARNING

- If 'Warning Only' is selected, braking is not assisted.
- If 'Off' is selected, the driver should always be aware of the surroundings and drive safely.



Information

If the engine is restarted, Blind-Spot Safety system will maintain the last setting.

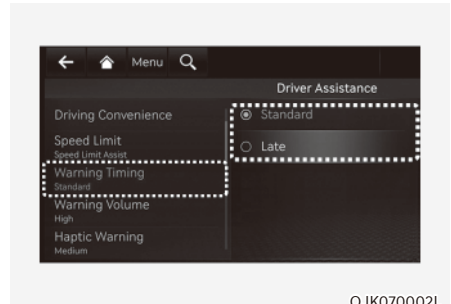

OJK070002L

Warning Timing

With the engine on, select 'Driver Assistance → Warning Timing' from the Settings menu to change the initial warning activation time for Blind-Spot Safety system.

When the vehicle is first delivered, Warning Timing is set to 'Standard'. If you change the Warning Timing, the warning time of other Driver Assistance systems may change.

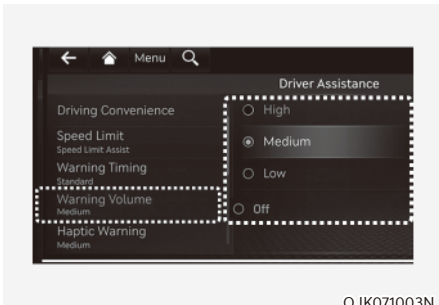

Warning Volume

With the engine on, select 'Driver Assistance → Warning volume' or 'Sound → Driver Assist Warning → Warning Volume' from the Settings menu to change the Warning Volume to 'High', 'Medium', 'Low' or 'Off' for Blind-Spot Safety system.

However, when Warning Volume is turned Off, the steering wheel vibration function will turn on if it was turned Off.

If you change the Warning Volume, the warning volume of other Driver Assistance systems may change.

CAUTION

- The setting of the Warning Timing and Warning Volume applies to all functions of Blind-Spot Safety system.
- Even though 'Standard' is selected for Warning Timing, if the vehicles approaches at high speed, the warning may seem late.
- Select 'Late' for Warning Timing when traffic is light and when driving speed is slow.

Blind-Spot Safety system operation

Warning and control

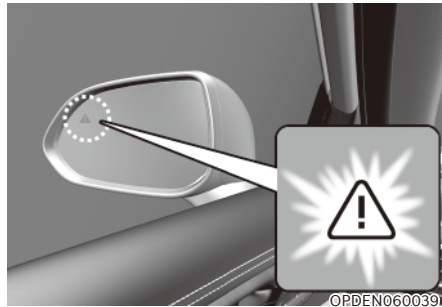

Vehicle detection

- To warn the driver a vehicle is detected, the warning light on the outside rearview mirror and head-up display (if equipped) will illuminate.
- The system will operate when your vehicle speed is above 20 km/h (12 mph) and the speed of the vehicle in the blind spot area is above 10 km/h (7 mph).

Collision warning

- Collision warning will operate when the turn signal is turned on in the direction of the detected vehicle.
- If 'Warning Only' is selected from the Settings menu, the collision warning will operate when your vehicle approaches the lane the blind spot vehicle is detected.
- To warn the driver of a collision, the warning light on the outside rearview mirror and head-up display (if equipped) will blink. At the same time, an audible warning will sound and the steering wheel will vibrate.
- When the turn signal is turned off or you move away from the lane, the collision warning will be canceled and the system will return to vehicle detection state.



WARNING

- **The detecting range of the rear corner radar is determined by a standard road width, therefore, on a narrow road, the system may detect other vehicles in the next next lane and warn you. In contrast, on a wide road, the system may not be able to detect a vehicle driving in the next lane and may not warn you.**
- **When the hazard warning flasher is on, the collision warning by the turn signal will not operate.**



Information

If the driver's seat is on the left side, the collision warning may occur when you turn left. Maintain a proper distance with the vehicles in the left lane. If the driver's seat is on the right side, the collision warning may occur when you turn right. Maintain a proper distance with the vehicles in the right lane.



Collision-avoidance assist (while driving)

- To warn the driver of a collision, the warning light on the outside rearview mirror will blink and a warning message will appear on the cluster. At the same time, an audible warning will sound, warning light on the head-up display (if equipped) will blink and the steering wheel will vibrate.
- The system will operate when your vehicle speed is between 60~200 km/h (40~120 mph) and both lane markings of the driving lane are detected.
- Emergency braking will be assisted to help prevent collision with the vehicle in the blind spot area.



WARNING

- **Collision-Avoidance Assist will be canceled under the following circumstances:**
 - Your vehicle enters the next lane by a certain distance
 - Your vehicle is away from the collision risk
 - The steering wheel is sharply steered
 - The brake pedal is depressed
 - Forward Collision-Avoidance Assist is operating
- **After Blind-Spot Collision-Avoidance Assist operation or lane change, you must drive to the center of the lane. The system will not operate if the vehicle is not driven in the center of the lane.**



©JK070079L

Collision-avoidance assist (while departing)

- To warn the driver of a collision, the warning light on the outside rearview mirror will blink and a warning message will appear on the cluster. At the same time, an audible warning will sound, warning light on the head-up display (if equipped) will blink and the steering wheel will vibrate.
- The system will operate when your vehicle speed is below 3 km/h (2 mph) and the speed of the vehicle in the blind spot area is above 5 km/h (3 mph).
- Emergency braking will be assisted to help prevent collision with the vehicle in the blind spot area.

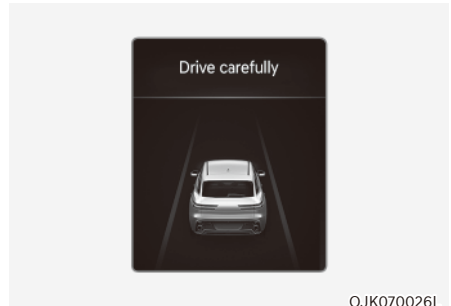

©JK070026L

- When the vehicle is stopped due to emergency braking, the 'Drive carefully' warning message will appear on the cluster.
For your safety, the driver should depress the brake pedal immediately and check the surroundings.
- Brake control will end after the vehicle is stopped by emergency braking for approximately 2 seconds.



WARNING

Take the following precautions when using Blind-Spot Safety system:

- For your safety, change the Settings after parking the vehicle at a safe location.
- If any other system's warning message is displayed or audible warning is generated, Blind-Spot Safety system's warning message may not be displayed and audible warning may not be generated.
- You may not hear the warning sound of Blind-Spot Safety system if the surrounding is noisy.
- Blind-Spot Safety system may not operate if the driver applies the brake pedal to avoid collision.
- When Blind-Spot Safety system is operating, braking control by the system will automatically cancel when the driver excessively depresses the accelerator pedal or sharply steers the vehicle.
- During Blind-Spot Safety system operation, the vehicle may stop suddenly injuring passengers and shifting loose objects. Always have the seat belt on and keep loose objects secured.
- Even if there is a problem with Blind-Spot Safety system, the vehicle's basic braking performance will operate normally.
- Blind-Spot Safety system does not operate in all situations or cannot avoid all collisions.

- Blind-Spot Safety system may warn the driver late or may not warn the driver depending on the road and driving conditions.
- Driver should maintain control of the vehicle at all times. Do not depend on Blind-Spot Safety system. Maintain a safe braking distance, and if necessary, depress the brake pedal to reduce driving speed or to stop the vehicle.
- Never operate Blind-Spot Safety system on people, animal, objects, etc. It may cause serious injury or death.



WARNING

The brake control may not operate properly depending on the status of ESC (Electronic Stability Control).

There will only be a warning when:

- The ESC (Electronic Stability Control) warning light is on
- ESC (Electronic Stability Control) is engaged in a different function

Blind-Spot Safety system malfunction and limitations

Blind-Spot Safety system malfunction

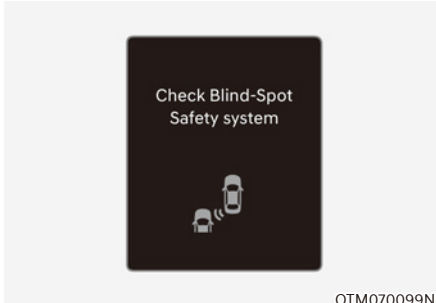

When Blind-Spot Safety system is not working properly, the 'Check Blind-Spot Safety system' warning message will appear on the cluster for several seconds, and the master (⚠) warning light will illuminate on the cluster. If this occurs, we recommend that the vehicle be inspected by an authorized retailer of Genesis Branded products.

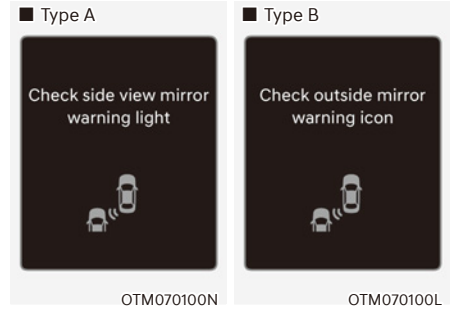

When the outside rearview mirror warning light is not working properly, the 'Check side view mirror warning light' (or 'Check outside mirror warning icon') warning message will appear on the cluster for several seconds, and the master (⚠) warning light will illuminate on the cluster. If this occurs, we recommend that the vehicle be inspected by an authorized retailer of Genesis Branded products.

Blind- Spot Safety system disabled

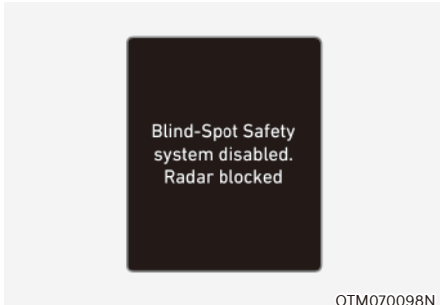

When the rear bumper around the rear corner radar or sensor is covered with foreign material, such as snow or rain, or installing a trailer or carrier, it can reduce the detecting performance and temporarily limit or disable Blind-Spot Safety system.

If this occurs, the 'Blind-Spot Safety system disabled. Radar blocked' warning message will appear on the cluster.

The system will operate normally when such foreign material or trailer, etc., is removed, and then the engine is restarted.

If the system does not operate normally after it is removed, we recommend that the vehicle be inspected by an authorized retailer of Genesis Branded products.

WARNING

- Even though the warning message does not appear on the cluster, Blind-Spot Safety system may not properly operate.
- Blind-Spot Safety system may not properly operate in an area (for example, open terrain) where any substance are not detected right after the engine is turned on, or when the detecting sensor is blocked with foreign material right after the engine is turned on.

CAUTION

Turn off Blind-Spot Collision-Avoidance Assist to install or remove a trailer, carrier, or another attachment. Turn on Blind-Spot Collision-Avoidance Assist when finished.

Limitations of Blind- Spot Safety system

Blind-Spot Safety system may not operate normally, or the system may operate unexpectedly under the following circumstances:

- There is inclement weather, such as heavy snow, heavy rain, etc.
- The rear corner radar is covered with snow, rain, dirt, etc.
- The temperature around the rear corner radar is high or low
- Driving on a highway (or motorway) ramp
- The road pavement (or the peripheral ground) abnormally contains metallic components (for example, possibly due to subway construction)

- There is a fixed object near the vehicle, such as sound barriers, guardrails, central dividers, entry barriers, street lamps, signs, tunnels, walls, etc. (including double structures)
- Driving in vast areas where there are few vehicles or structures (for example, desert, meadow, suburb, etc.)
- Driving through a narrow road where trees or grass are overgrown
- Driving on a wet road surface, such as a puddle on the road
- The other vehicle drives very close behind your vehicle, or the other vehicle passes by your vehicle in close proximity
- The speed of the other vehicle is very fast that it passes by your vehicle in a short time
- Your vehicle passes by the other vehicle
- Your vehicle changes lane
- Your vehicle has started at the same time as the vehicle next to you and has accelerated
- The vehicle in the next lane moves two lanes away from you, or when the vehicle two lanes away moves to the next lane from you
- A trailer or carrier is installed around the rear corner radar
- The bumper around the rear corner radar is covered with objects, such as a bumper sticker, bumper guard, bike rack, etc.
- The bumper around the rear corner radar is impacted, damaged or the radar is out of position
- Your vehicle height is low or high due to heavy loads, abnormal tire pressure, etc.

Blind-Spot Safety system may not operate normally, or the system may operate unexpectedly when the following objects are detected:

- A motorcycle or bicycle is detected
- A vehicle such as a flat trailer is detected
- A big vehicle such as a bus or truck is detected
- A moving obstacle such as a pedestrian, animal, shopping cart or a baby stroller is detected
- A vehicle with low height such as a sports car is detected

Braking control may not work, driver's attention is required in the following circumstances:

- The vehicle severely vibrates while driving over a bumpy road, uneven road or concrete patch
- Driving on a slippery surface due to snow, water puddle, ice, etc.
- The tire pressure is low or a tire is damaged
- The braking system has been modified
- The vehicle makes abrupt lane changes

Information

For more details on the limitations of the front view camera, refer to “Forward Collision-Avoidance Assist (FCA)” and “Lane Keeping Assist (LKA)” section in this chapter.



WARNING

- Driving on a curved road

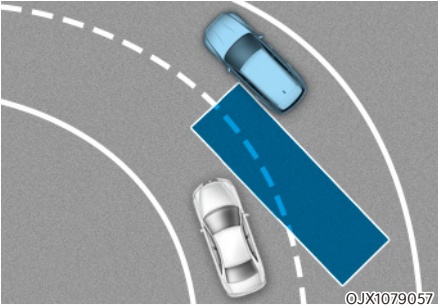

Blind-Spot Safety system may not operate properly when driving on a curved road. The system may not detect the vehicle in the next lane. Always pay attention to road and driving conditions while driving.

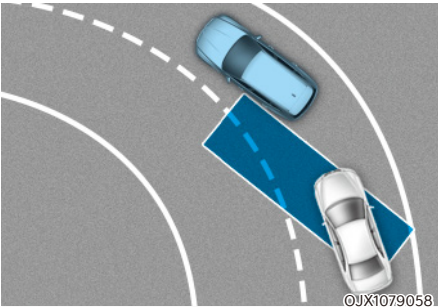

Blind-Spot Safety system may not operate properly when driving on a curved road. The system may recognize a vehicle in the same lane. Always pay attention to road and driving conditions while driving.

- Driving where the road is merging/dividing

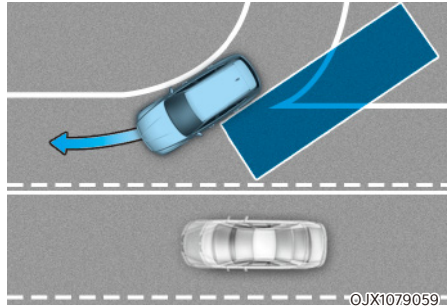

Blind-Spot Safety system may not operate properly when driving where the road merges or divides. The system may not detect the vehicle in the next lane. Always pay attention to road and driving conditions while driving.

- Driving on an inclined road

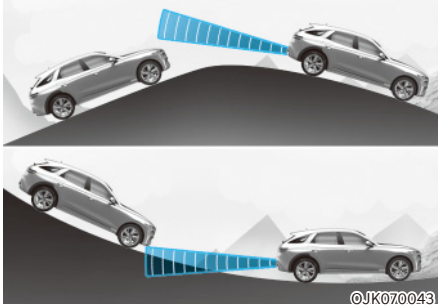

Blind-Spot Safety system may not operate properly when driving on a slope. The system may not detect the vehicle in the next lane or may incorrectly detect the ground or structure.

Always pay attention to road and driving conditions while driving.

- Driving where the heights of the lanes are different

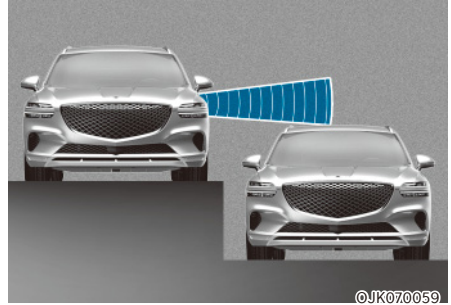

Blind-Spot Safety system may not operate properly when driving where the heights of the lanes are different. The system may not detect the vehicle on a road with different lane heights (underpass joining section, grade separated intersections, etc.).

Always pay attention to road and driving conditions while driving.

WARNING

- When you are towing a trailer or another vehicle, make sure that you turn off Blind-Spot Safety system.
- Blind-Spot Safety system may not operate normally if interfered by strong electromagnetic waves.
- Blind-Spot Safety system may not operate for 15 seconds after the vehicle is started, or the front view camera or rear corner radars are initialized.

SAFE EXIT WARNING (SEW) (IF EQUIPPED)

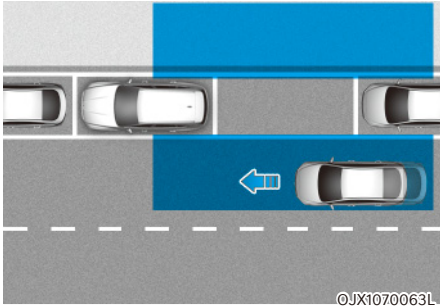

After the vehicle stops, when an approaching vehicle from the rear area is detected as soon as a passenger opens a door, Safe Exit Warning will warn the driver with a warning message and an audible warning to help prevent a collision.

CAUTION

Warning timing may vary depending on the speed of the approaching vehicle.

Detecting sensor



[1] : Rear corner radar

Refer to the picture above for the detailed location of the detecting sensors.

CAUTION

For more details on the precautions of the rear corner radars, refer to “Blind-Spot Collision Warning (BCA)” section in this chapter.

Safe Exit Warning settings

Setting features

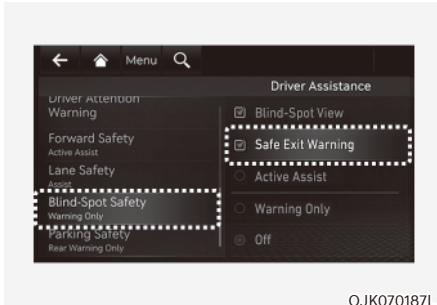

Safe Exit Warning

With the engine on, select 'Driver Assistance → Blind-Spot Safety → Safe Exit Warning' from the Settings menu to turn on Safe Exit Warning and deselect to turn off the function.



WARNING

The driver should always be aware of unexpected and sudden situations from occurring. If 'Safe Exit Warning' is deselected, Safe Exit Warning cannot assist you.



Information

If the engine is restarted, Safe Exit Warning will maintain the last setting.

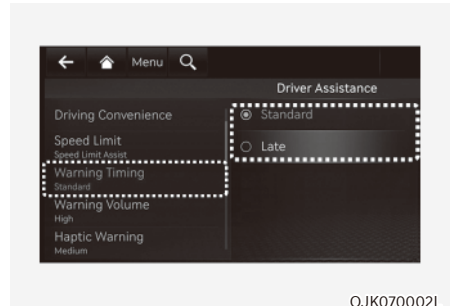

Warning Timing

With the engine on, select 'Driver Assistance → Warning Timing' from the Settings menu to change the initial warning activation time for Safe Exit Warning.

When the vehicle is first delivered, Warning Timing is set to 'Standard'. If you change the Warning Timing, the warning time of other Driver Assistance systems may change.

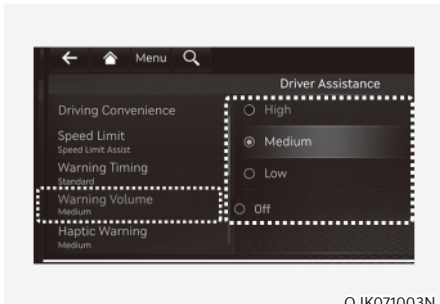

OJK071003N

Warning Volume

With the engine on, select 'Driver Assistance → Warning volume' or 'Sound → Driver Assist Warning → Warning Volume' from the Settings menu to change the Warning Volume to 'High', 'Medium', 'Low' or 'Off' for Safe Exit Warning.

However, even if 'Off' is selected, the Warning Volume of Safe Exit Warning will not turn off but the volume will sound as 'Low'.

If you change the Warning Volume, the warning volume of other Driver Assistance systems may change.



CAUTION

- **The setting of the Warning Timing and Warning Volume applies to all functions of Safe Exit Warning.**
- **Even though 'Standard' is selected for Warning Timing, if a vehicle approaches at high speed from the rear, the warning may seem late.**
- **Select 'Late' for Warning Timing when traffic is light and when driving speed is slow.**

Safe Exit Warning operation

Safe Exit Warning

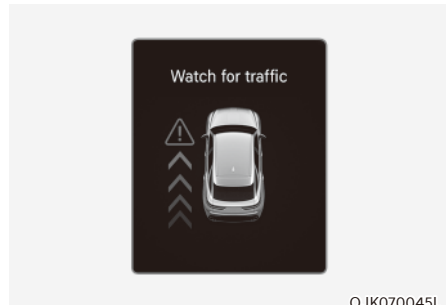

OJK070045L

Collision warning when exiting vehicle

- When an approaching vehicle from the rear is detected at the moment a door is opened, the 'Watch for traffic' warning message will appear on the cluster, and an audible warning will sound.
- Safe Exit Warning will warn the driver when your vehicle speed is below 3 km/h (2 mph), and the speed of the approaching vehicle from the rear is above 6 km/h (4 mph).



WARNING

Take the following precautions when using Safe Exit Warning:

- For your safety, change the Settings after parking the vehicle at a safe location.
- If any other system's warning message is displayed or audible warning is generated, Safe Exit Warning's warning message may not be displayed and audible warning may not be generated.
- You may not hear the warning sound of Safe Exit Warning if the surrounding is noisy.
- Safe Exit Warning does not operate in all situations or cannot prevent all collisions.
- Safe Exit Warning may warn the driver late or may not warn the driver depending on the road and driving conditions. Always check vehicle surroundings.
- The driver and passengers are responsible for accidents that occurs while exiting the vehicle. Always check the surroundings before you exit the vehicle.
- Never deliberately operate Safe Exit Warning. Doing so may lead to serious injury or death.
- Safe Exit Warning does not operate if there is a problem with Blind-Spot Safety system. The warning message of Blind-Spot Safety system will appear when:
 - Blind-Spot Safety system sensor or the sensor surrounding is polluted or covered
 - Blind-Spot Safety system fails to warn passengers or falsely warn passengers



Information

After the engine is turned off, Safe Exit Warning operates approximately for 3 minutes, but turns off immediately if the doors are locked.

Safe Exit Warning malfunction and limitations

Safe Exit Warning malfunction



When Safe Exit Warning is not working properly, the 'Check Blind-Spot Safety system' warning message will appear on the cluster for several seconds, and the master (⚠) warning light will illuminate on the cluster. If this occurs, we recommend that the vehicle be inspected by an authorized retailer of Genesis Branded products.

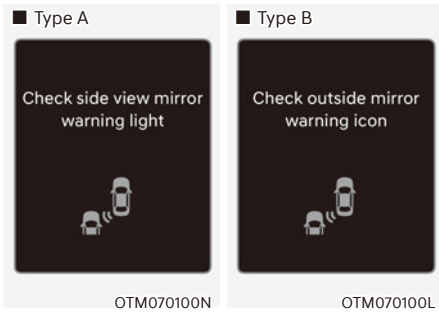

When the outside rearview mirror warning light is not working properly, the 'Check side view mirror warning light' (or 'Check outside mirror warning icon') warning message will appear on the cluster for several seconds, and the master (⚠) warning light will illuminate on the cluster. If this occurs, we recommend that the vehicle be inspected by an authorized retailer of Genesis Branded products.

Safe Exit Warning disabled

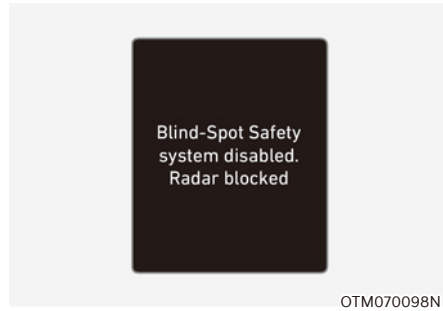

When the rear bumper around the rear corner radar or sensor is covered with foreign material, such as snow or rain, or installing a trailer or carrier, it can reduce the detecting performance and temporarily limit or disable Safe Exit Warning.

If this occurs, the 'Blind-Spot Safety system disabled. Radar blocked' warning message will appear on the cluster.

Safe Exit Warning will operate normally when such foreign material or trailer, etc., is removed, and then the engine is restarted.

If Safe Exit Warning does not operate normally after it is removed, we recommend that the vehicle be inspected by an authorized retailer of Genesis Branded products.

**WARNING**

- Even though the warning message does not appear on the cluster, Safe Exit Warning may not properly operate.
- Safe Exit Warning may not properly operate in an area (for example, open terrain) where any substance are not detected right after the engine is turned on, or when the detecting sensor is blocked with foreign material right after the engine is turned on.

**CAUTION**

Turn off Safe Exit Warning to install or remove a trailer, carrier, or another attachment. Turn on Safe Exit Warning when finished.

Limitations of Safe Exit Warning

Safe Exit Warning may not operate normally, or it may operate unexpectedly under the following circumstances:

- Getting out of the vehicle where trees or grass are overgrown
- Getting out of the vehicle where the road is wet
- The approaching vehicle is very fast or very slow

**Information**

For more details on the limitations of the rear corner radar, refer to “Blind- Spot Collision-Avoidance Assist (BCA)” section in this chapter.

**WARNING**

- Safe Exit Warning may not operate normally if interfered by strong electromagnetic waves.
- Safe Exit Warning may not operate for 3 seconds after the vehicle is started, or the rear corner radars are initialized.

SAFE EXIT ASSIST (SEA) (IF EQUIPPED)

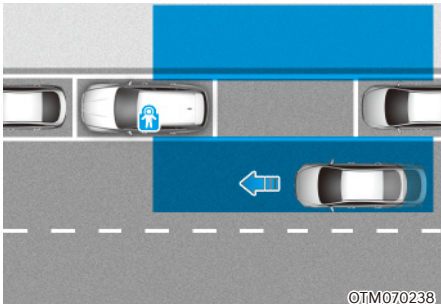

After the vehicle stops, when an approaching vehicle from the rear area is detected as soon as a passenger opens a door, Safe Exit Assist will warn the driver with a warning message and an audible warning to help prevent a collision.



In addition, when the electronic child safety lock button is in the LOCK position and an approaching vehicle from the rear area is detected, the electronic child safety lock button will not unlock even if the driver presses the button to prevent the rear doors from opening.

CAUTION

Warning timing may vary depending on the speed of the approaching vehicle.

Detecting sensor



[1] : Rear corner radar

Refer to the picture above for the detailed location of the detecting sensors.

CAUTION

For more details on the precautions of the rear corner radars, refer to “Blind-Spot Collision Assist (BCA)” section in this chapter.

Safe Exit Assist settings

Setting features

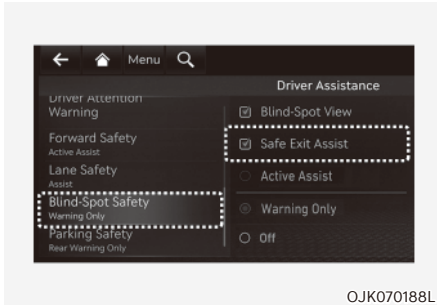

Safe Exit Assist

With the engine on, select 'Driver Assistance → Blind-Spot Safety → Safe Exit Assist' from the Settings menu to turn on Safe Exit Assist and deselect to turn off the function.



WARNING

The driver should always be aware of unexpected and sudden situations from occurring. If 'Safe Exit Assist' is deselected, Safe Exit Assist cannot assist you.



Information

If the engine is restarted, Safe Exit Assist will maintain the last setting.

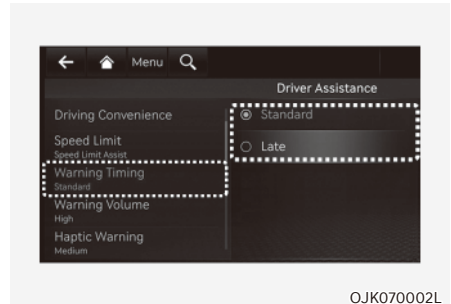

Warning Timing

With the engine on, select 'Driver Assistance → Warning Timing' from the Settings menu to change the initial warning activation time for Safe Exit Assist.

When the vehicle is first delivered, Warning Timing is set to 'Standard'. If you change the Warning Timing, the warning time of other Driver Assistance systems may change.

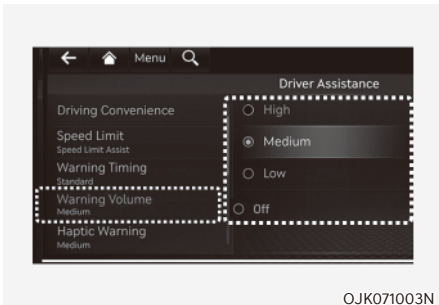

Warning Volume

With the engine on, select 'Driver Assistance → Warning volume' or 'Sound → Driver Assist Warning → Warning Volume' from the Settings menu to change the Warning Volume 'High', 'Medium', 'Low' or 'Off' for Safe Exit Assist.

However, even if 'Off' is selected, the Warning Volume of Safe Exit Assist will not turn off but the volume will sound as 'Low'.

If you change the Warning Volume, the warning volume of other Driver Assistance systems may change.

CAUTION

- The setting of the **Warning Timing and Warning Volume applies to all functions of the Safe Exit Assist.**
- **Even though 'Standard' is selected for Warning Timing, if a vehicle approaches at high speed from the rear, the warning may seem late.**
- **Select 'Late' for Warning Timing when traffic is light and driving speed is slow.**

Safe Exit Assist operation

Warning and control

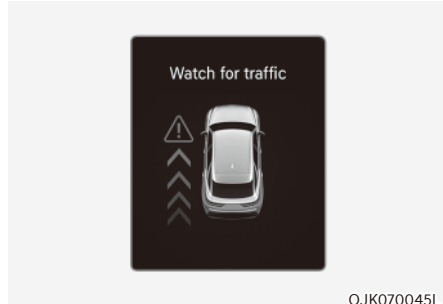

Collision warning when exiting vehicle

- When an approaching vehicle from the rear is detected at the moment a door is opened, the 'Watch for traffic' warning message will appear on the cluster, and an audible warning will sound.
- Safe Exit Assist will warn the driver when your vehicle speed is below 3 km/h (2 mph), and the speed of the approaching vehicle from the rear is above 6 km/h (4 mph).

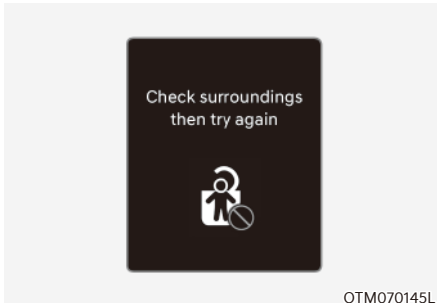

Safe Exit Assist linked with Electronic child safety lock

- When Electric child safety lock is operating and an approaching vehicle from the rear area is detected, the rear doors cannot be unlocked even if the driver tries to unlock the rear doors using the electronic child safety lock button. The warning light on the outside rearview mirror will blink and the 'Check surroundings then try again' warning message will appear on the cluster.
- Safe Exit Assist will warn the driver when vehicle speed is below 3 km/h (2 mph) and the speed of the approaching vehicle from the rear is above 6 km/h (4 mph).
- For more details on electric child safety lock button, refer to "Electronic Child Safety Lock" section in chapter 5.



CAUTION

If the driver presses the electronic child lock button again within 10 seconds after the warning message appears, Safe Exit Assist judges that the driver has unlocked the doors acknowledging the rear status. The electronic child safety lock will turn off (button indicator OFF) and the rear doors will unlock. Always check the surroundings before turning off the electronic child safety lock button.



WARNING

Take the following precautions when using Safe Exit Assist:

- For your safety, change the Settings after parking the vehicle at a safe location.
- If any other system's warning message is displayed or audible warning is generated, Safe Exit Assist warning message may not be displayed and audible warning may not be generated.
- You may not hear the warning sound of Safe Exit Assist if the surrounding is noisy.
- Safe Exit Assist does not operate in all situations or cannot prevent all collisions.

- **Safe Exit Assist may warn the driver late or may not warn the driver depending on the road and driving conditions. Always check vehicle surroundings.**
- **The driver and passengers are responsible for accidents that occurs while exiting the vehicle. Always check the surroundings before you exit the vehicle.**
- **Never deliberately operate Safe Exit Assist. Doing so may lead to serious injury or death.**
- **Safe Exit Assist does not operate if there is a problem with Blind-Spot Safety system. The warning message of Blind-Spot Safety system will appear when:**
 - **Blind-Spot Safety system sensor or the sensor surrounding is polluted or covered**
 - **Blind-Spot Safety system fails to warn passengers or falsely warn passengers**

i Information

After the engine is turned off, Safe Exit Assist operates approximately for 3 minutes, but turns off immediately if the doors are locked.

Safe Exit Assist malfunction and limitations

Safe Exit Assist malfunction

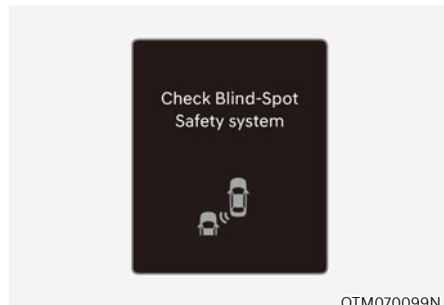

When Safe Exit Assist is not working properly, the 'Check Blind-Spot Safety system' warning message will appear on the cluster for several seconds, and the master (⚠) warning light will illuminate on the cluster. If this occurs, we recommend that the vehicle be inspected by an authorized retailer of Genesis Branded products.

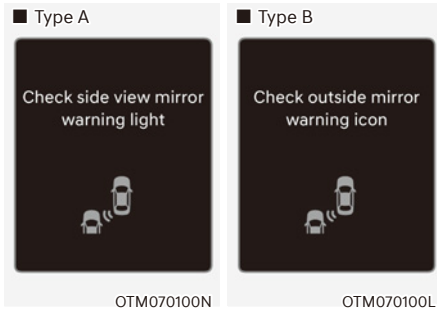

When the outside rearview mirror warning light is not working properly, the 'Check side view mirror warning light' (or 'Check outside mirror warning icon') warning message will appear on the cluster for several seconds, and the master () warning light will illuminate on the cluster. If this occurs, we recommend that the vehicle be inspected by an authorized retailer of Genesis Branded products.

Safe Exit Assist disabled



When the rear bumper around the rear corner radar or sensor is covered with foreign material, such as snow or rain, or installing a trailer or carrier, it can reduce the detecting performance and temporarily limit or disable Safe Exit Assist.

If this occurs, the 'Blind-Spot Safety system disabled. Radar blocked' warning message will appear on the cluster.

Safe Exit Assist will operate normally when such foreign material or trailer, etc., is removed, and then the engine is restarted.

If Safe Exit Assist does not operate normally after it is removed, we recommend that the vehicle be inspected by an authorized retailer of Genesis Branded products.



WARNING

- Even though the warning message does not appear on the cluster, Safe Exit Assist may not properly operate.
- Safe Exit Assist may not properly operate in an area (for example, open terrain) where any substance are not detected right after the engine is turned on, or when the detecting sensor is blocked with foreign material right after the engine is turned on.



WARNING

- Safe Exit Assist may not operate normally if interfered by strong electromagnetic waves.
- Safe Exit Assist may not operate for 3 seconds after the vehicle is started, or the rear corner radars are initialized.



CAUTION

Turn off Safe Exit Assist to install or remove a trailer, carrier, or another attachment. Turn on Safe Exit Assist when finished.

Limitations of Safe Exit Assist

Safe Exit Assist may not operate normally, or it may operate unexpectedly under the following circumstances:

- Getting out of the vehicle where trees or grass are overgrown
- Getting out of the vehicle where the road is wet
- The approaching vehicle is very fast or very slow



Information

For more details on the limitations of the rear corner radar, refer to “Blind- Spot Collision-Avoidance Assist (BCA)” section in this chapter.

MANUAL SPEED LIMIT ASSIST (MSLA)

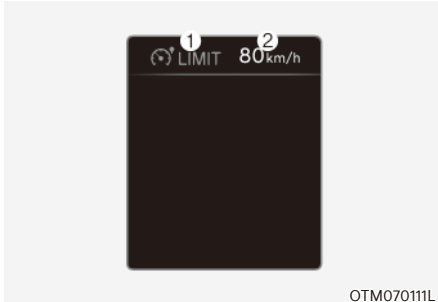

- (1) Speed Limit indicator
- (2) Set speed

You can set the speed limit when you do not want to drive over a specific speed. If you drive over the preset speed limit, Manual Speed Limit Assist will operate (set speed limit will blink and chime will sound) until the vehicle speed returns within the speed limit.

Manual Speed Limit Assist operation

Setting speed limit

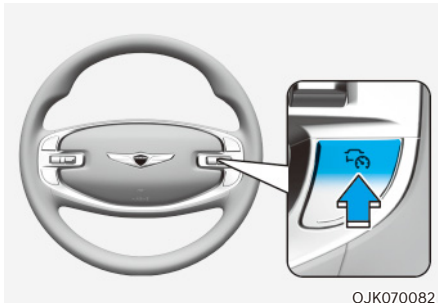

1. Press and hold Driving Assist (Ⓜ) button at the desired speed. The Speed Limit (LIMIT) indicator will illuminate on the cluster.

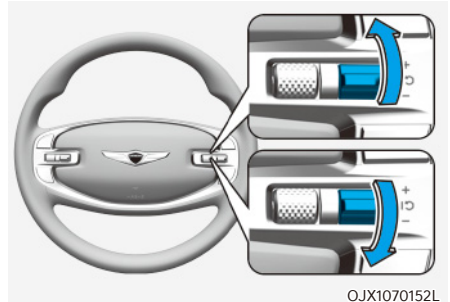

2. Push the + switch up or - switch down, and release it at the desired speed. Push the + switch up or - switch down and hold it. The speed will increase or decrease to the nearest multiple of ten (multiple of five in mph) at first, and then increase or decrease by 10 km/h (5 mph).

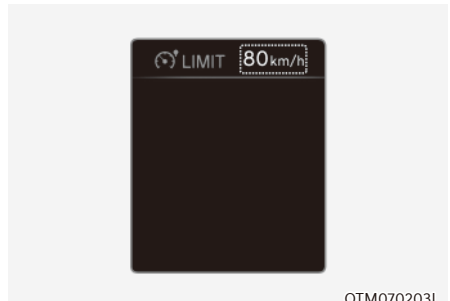

3. The set speed limit will be displayed on the cluster. If you would like to drive over the preset speed limit, depress the accelerator pedal beyond the pressure point to activate the kickdown mechanism. The set speed limit will blink and chime will sound until you return the vehicle speed within the speed limit.

i Information

- When the accelerator pedal is not depressed beyond the pressure point, vehicle speed will maintain within the speed limit.
- A clicking sound may be heard from the kickdown mechanism when the accelerator pedal is depressed beyond the pressure point.

Temporarily pausing Manual Speed Limit Assist

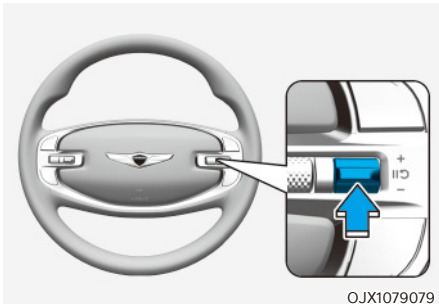

Push the II (pause) switch to temporarily pause the set speed limit. The set speed limit will turn off but the Speed Limit (LIMIT) indicator will stay on.

Resuming Manual Speed Limit Assist

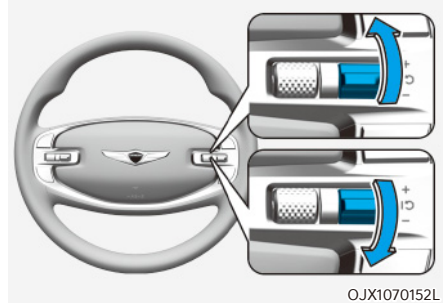

To resume Manual Speed Limit Assist after the function was paused, push the +, -, II (pause) switch.

If you push the + switch up or - switch down, vehicle speed will be set to the current speed on the cluster.

If you push the II (pause) switch, vehicle speed will resume to the preset speed.

Turning off Manual Speed Limit Assist

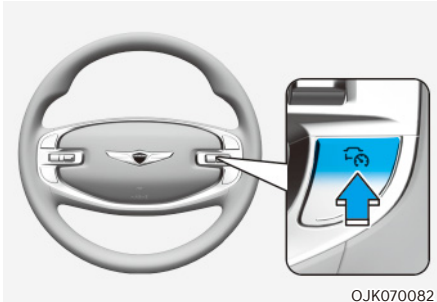

Press the Driving Assist (ⓘ) button to turn Manual Speed Limit Assist off. The Speed Limit (ⓘ) LIMIT indicator will go off.

Always press the Driving Assist (ⓘ) button to turn Manual Speed Limit Assist off when not in use.

WARNING

Take the following precautions when using Manual Speed Limit Assist:

- Always set the vehicle speed to the speed limit in your country.
- Keep Manual Speed Limit Assist off when the function is not in use, to avoid inadvertently setting a speed. Check that the Speed Limit (ⓘ) LIMIT indicator is off.
- Manual Speed Limit Assist does not substitute for proper and safe driving. It is the responsibility of the driver to always drive safely and should always be aware of unexpected and sudden situations from occurring. Pay attention to the road conditions at all times.

INTELLIGENT SPEED LIMIT ASSIST (ISLA) (IF EQUIPPED)

Intelligent Speed Limit Assist uses information from the detected road sign and navigation system to inform the driver of the speed limit of the current road. Also, Intelligent Speed Limit Assist helps the driver to maintain within the speed limit of the road.

CAUTION

Intelligent Speed Limit Assist may not operate properly if the function is used in other countries.

Detecting sensor



[1]: Front view camera

Refer to the picture above for the detailed location of the detecting sensor.

CAUTION

For more details on the precautions of the front view camera, refer to “Forward Collision-Avoidance Assist (FCA)” section in this chapter.

Information

If the navigation system is available, the information from the navigation system is used along with the road sign information detected by the front view camera.

Intelligent Speed Limit Assist settings

Setting features

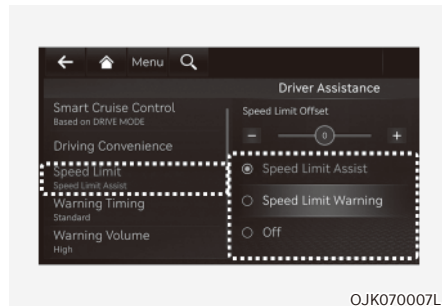

Speed Limit

With the engine on, select or deselect ‘Driver Assistance → Speed Limit’ from the Settings menu to set whether to use each function.

- If ‘Speed Limit Assist’ is selected, Intelligent Speed Limit Assist will inform the driver of speed limit. In addition, Intelligent Speed Limit Assist will inform the driver to change set speed of Manual Speed Limit Assist and/or Smart Cruise Control to help the driver stay within the speed limit.
- If ‘Speed Limit Warning’ is selected, Intelligent Speed Limit Assist will inform the driver of speed limit. In addition, Intelligent Speed Limit Assist will warn the driver when the vehicle is driven faster than the speed limit.
- If ‘Off’ is selected, Intelligent Speed Limit Assist will turn off.

CAUTION

If ‘Speed Limit Warning’ is selected, Intelligent Speed Limit Assist will not inform the driver to adjust set speed.

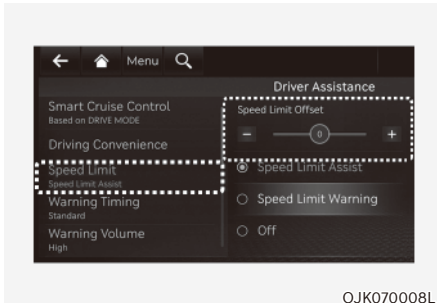

OJK070008L

Speed Limit Offset

With the engine on, when 'Driver Assistance → Speed Limit → Speed Limit Offset' is selected, the Speed Limit Offset can be changed. Speed Limit Warning and Speed Limit Assist will operate by applying the Speed Limit Offset setting to the detected speed limit.

WARNING

- For your safety, change the Settings after parking the vehicle at a safe location.
- Speed Limit Assist function operates based on the Offset setting added to the speed limit. If you want to change the set speed according to the speed limit, adjust the offset to '0'.
- Speed Limit Warning function warns the driver when driving speed exceeds the speed at which the set Offset is added to speed limit. If you want Speed Limit Warning to warn you immediately when the driving speed exceeds the speed limit, adjust the offset to '0'.

Information

The setting of 'Speed Offset' is not reflected in Navigation-based Smart Cruise Control (NSCC).

Intelligent Speed Limit Assist operation

Warning and control

Intelligent Speed Limit Assist will warn and control the vehicle by 'Displaying speed limit', 'Warning overspeed' and 'Changing set speed'.

Information

Intelligent Speed Limit Assist warning and control are described based on the Offset adjust to '0'. For details on Offset setting, refer to the "Intelligent Speed Limit Assist Settings".

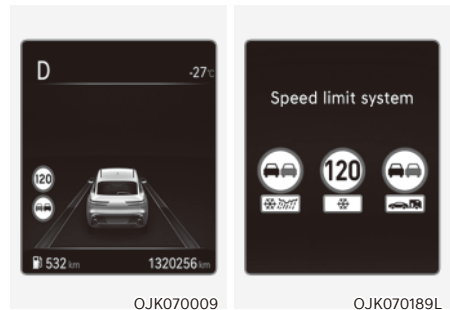

OJK070009

OJK070189L

Displaying speed limit

Speed limit information is displayed on the instrument cluster.

Information

- If speed limit information of the road cannot be recognized, "—" sign will be displayed. Please refer to "Limitations of Intelligent Speed Limit Assist" if the road signs are difficult to recognize.
- Intelligent Speed Limit Assist provides additional road sign information in addition to speed limit. The additional road sign information provided may vary according to your country.
- Supplementary sign displayed under the speed limit or overtaking restriction sign means the conditions under which the signs must be followed. If the supplementary sign is not recognized, it will be displayed as blank.

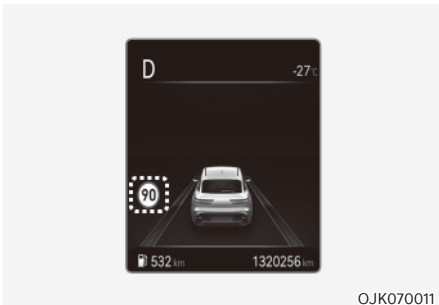

Warning overspeed

When driving at a speed higher than the displayed speed limit, the red speed limit indicator will blink.



Changing set speed

If the speed limit of the road changes during the operation of Manual Speed Limit Assist or Smart Cruise Control, an arrow in the direction of up or down is displayed to inform the driver that the set speed needs to be changed. At this time, the driver can change the set speed according to the speed limit by using the + or - switch on the steering wheel.

WARNING

- If the Offset is adjusted over '0', the set speed will change to a higher speed than the speed limit of the road. If you want to drive below the speed limit, adjust the Offset under '0' or use the - switch on the steering wheel to lower the set speed.
- Even after changing the set speed according to the speed limit of the road, the vehicle can still be driven over the speed limit. If necessary, depress the brake pedal to reduce your driving speed.
- If the speed limit of the road is under 30 km/h (20 mph), the set speed change function will not work.
- Intelligent Speed Limit Assist operates using the speed unit in the instrument cluster set by the driver. If the speed unit is set to a unit other than the speed unit used in your country, Intelligent Speed Limit Assist may not operate properly.

Information

- For more details on Manual Speed Limit Assist operation, refer to “Manual Speed Limit Assist (MSLA)” section in this chapter.
- For more details on Smart Cruise Control operation, refer to “Smart Cruise Control (SCC)” section in this chapter.

Intelligent Speed Limit Assist malfunction and limitations

Intelligent Speed Limit Assist malfunction

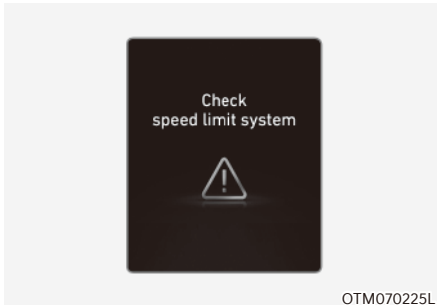

When Intelligent Speed Limit Assist is not working properly, the 'Check speed limit system' warning message will appear on the cluster. If this occurs, we recommend that the vehicle be inspected by an authorized retailer of Genesis Branded products.

Intelligent Speed Limit Assist disabled

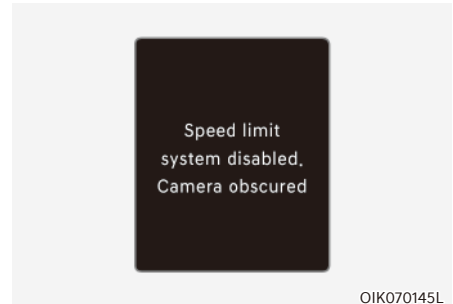

When the front windshield where the front view camera is located is covered with foreign material, such as snow or rain, it can reduce the detecting performance and temporarily limit or disable Intelligent Speed Limit Assist. If this occurs, the 'Speed limit system disabled. Camera obscured' warning message will appear on the cluster.

Intelligent Speed Limit Assist will operate normally when snow, rain or foreign material is removed.

If Intelligent Speed Limit Assist does not operate normally after it is removed, we recommend that the vehicle be inspected by an authorized retailer of Genesis Branded products.

WARNING

- Even though the warning message or warning light does not appear on the cluster, Intelligent Speed Limit Assist may not operate properly.
- If the detecting sensor is contaminated immediately after starting the engine, Intelligent Speed Limit Assist may not operate properly.

Limitations of Intelligent Speed Limit Assist

Intelligent Speed Limit Assist may not operate normally, or it may operate unexpectedly under the following circumstances:

- The road sign is contaminated or indistinguishable
 - The road sign is difficult to see due to bad weather, such as rain, snow, fog, etc.
 - The road sign is not clear or damaged
 - The road sign is partially obscured by surrounding objects or shadow
- The road signs do not conform to the standard
 - The text or picture on the road sign is different from the standard
 - The road sign is installed between the main line and the exit road or between diverging roads
 - There is no conditional road signs on the road sign located on the exit road
 - A sign is attached to another vehicle
- The distance between the vehicle and the road signs is too far
- The vehicle encounters illuminant road signs
- Intelligent Speed Limit Assist incorrectly recognizes numbers or pictures in the street signals or other signs as the speed limit
- A road sign near the road you are driving is detected
- The minimum speed limit sign is misrecognized
- The minimum speed limit sign is on the road
- The brightness changes suddenly, for example when entering or exiting a tunnel or passing under a bridge

- Headlamps are not used or the brightness of the headlamps are weak at night or in the tunnel
- Road signs are difficult to recognize due to the reflection of sunlight, street lights, or oncoming vehicles
- The navigation information or GPS information contain errors.
- The driver does not follow the guide of the navigation.
- The driver is driving a new road that is not in the navigation system yet.
- The field of view of the front view camera is obstructed by sun glare
- Driving on a road that is sharply curved or continuously curved
- Driving through speed bumps, or driving up and down or left to right on steep inclines
- The vehicle is shaking heavily
- Driving on a newly opened road

Information

For more details on the limitations of the front view camera, refer to “Forward Collision-Avoidance Assist (FCA)” section in this chapter.

WARNING

- **Intelligent Speed Limit Assist is a supplemental function that helps the driver to comply with the speed limit on the road, and may not display the correct speed limit or control the driving speed properly.**
- **Always set the vehicle speed to the speed limit in your country.**

DRIVER ATTENTION WARNING (DAW)

Basic function

Driver Attention Warning helps determine the driver's attention level by analyzing driving pattern, driving time, etc., while vehicle is driven. Driver Attention Warning will recommend a break when the driver's attention level falls below a certain level.

Leading vehicle departure alert function

Leading Vehicle Departure Alert function will inform the driver when the front vehicle departs from a stop.

Detecting sensor

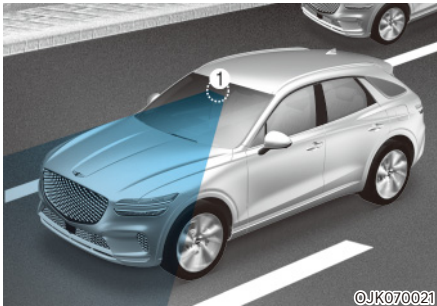

[1]: Front view camera

The front view camera is used as a detecting sensor to help detect driving patterns and front vehicle departure while vehicle is being driven.

Refer to the picture above for the detailed location of the detecting sensor.

CAUTION

- Always keep the front view camera in good condition to maintain optimal performance of Driver Attention Warning.
- For more details on the precautions of the front view camera, refer to “Forward Collision-Avoidance Assist (FCA)” section in this chapter.

Driver Attention Warning settings

Setting features

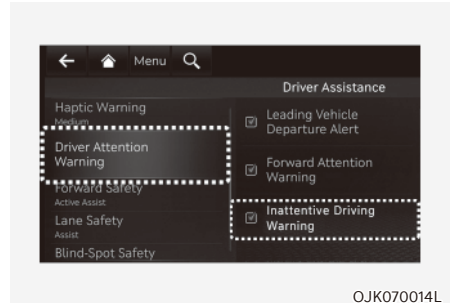

Driver Attention Warning

With the engine on, select or deselect ‘Driver Assistance → Driver Attention Warning’ from the Settings menu to set whether to use each function.

- If ‘Inattentive Driving Warning’ is selected, Driver Attention Warning will inform the driver the driver's attention level and will recommend taking a break when the level falls below a certain level.

Information

Whenever the engine is turned on, Inattentive Driving Warning will always turn on. (For Europe, Australia, Russia)

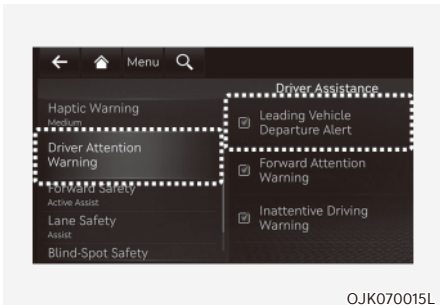

OJK070015L

Leading Vehicle Departure Alert

- If 'Leading Vehicle Departure Alert' is selected, the function will inform the driver when the front vehicle departs from a stop.

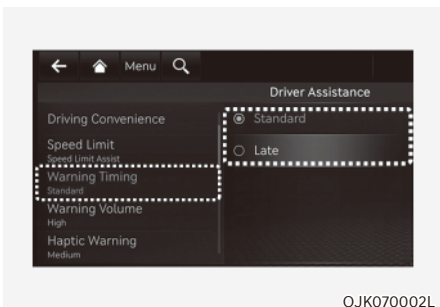

OJK070002L

Warning Timing

With the engine on, select 'Driver Assistance → Warning Timing' from the Settings menu to change the initial warning activation time for Driver Attention Warning.

When the vehicle is first delivered, Warning Timing is set to 'Standard'. If you change the Warning Timing, the warning time of other Driver Assistance systems may change.

Information

If the engine is restarted, Driver Attention Warning will maintain the last setting.

Driver Attention Warning operation

Basic function

Display and warning

The basic function of Driver Attention Warning is to inform the driver the 'Attention Level' and to warn the driver 'Consider taking a break'.

Attention level

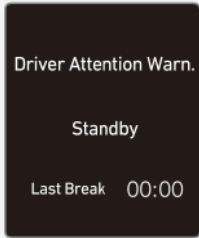
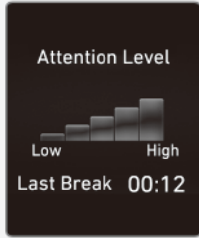
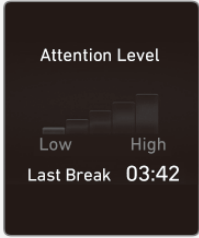
Function off	Standby/Disabled
	
OTM070102N	OTM070106N
Attentive driving	Inattentive driving
	
OJK070140L	OJX1079066L

- The driver can monitor his/her driving conditions on the cluster.
 - When the 'Inattentive Driving Warning' is deselected from the Settings menu, 'System Off' is displayed.
 - Driver Attention Warning will operate when vehicle speed is between 0~210 km/h (0~130 mph).
 - When vehicle speed is not within the operating speed, the message 'Standby' (or 'Disabled') will be displayed.

- The driver's attention level is displayed on the scale of 1 to 5. The lower the level is, the more inattentive the driver is.
- The level decreases when the driver does not take a break for a certain period of time.

Taking a break

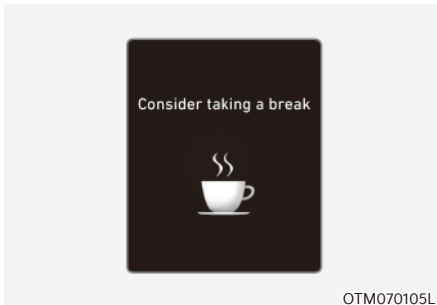

- The 'Consider taking a break' message will appear on the cluster and an audible warning will sound to suggest that the driver take a break, when the driver's attention level is below 1.
- Driver Attention Warning will not suggest a break when the total driving time is shorter than 10 minutes or 10 minutes has not passed after the last break was suggested.



WARNING

For your safety, change the Settings after parking the vehicle at a safe location.



CAUTION

- Driver Attention Warning may suggest a break depending on the driver's driving pattern or habits, even if the driver doesn't feel fatigued.
- Driver Attention Warning is a supplemental function and may not be able to determine whether the driver is inattentive.
- The driver who feels fatigued should take a break at a safe location, even though there is no break suggestion by Driver Attention Warning.



Information

- For more details on setting the functions in the infotainment system, refer to "Vehicle Settings" section in chapter 4.
- Driver Attention Warning will reset the last break time to 00:00 in the following situations:
 - The engine is turned off
 - The driver unfastens the seat belt and opens the driver's door
 - The vehicle is stopped for more than 10 minutes
- When the driver resets Driver Attention Warning, the last break time is set to 00:00 and the driver's attention level is set to High.

Leading vehicle departure alert function

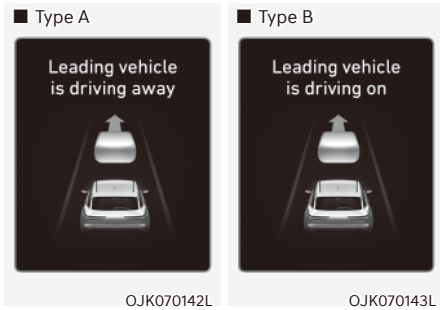

When the front vehicle departs from a stop, Leading Vehicle Departure Alert will inform the driver by displaying the 'Leading vehicle is driving away' (or 'Leading vehicle is driving on') message on the cluster and an audible warning will sound.

WARNING

- If any other system's warning message is displayed or audible warning is generated, Leading Vehicle Departure Alert's warning message may not be displayed and audible warning may not be generated.
- The driver should hold the responsibility to safely drive and control the vehicle.

CAUTION

- Leading Vehicle Departure Alert is a supplemental function and may not alert the driver whenever the front vehicle departs from a stop.
- Always check the front of the vehicle and road conditions before departure.

Driver Attention Warning malfunction and limitations

Driver Attention Warning malfunction



When Driver Attention Warning is not working properly, the 'Check Driver Attention Warning (DAW) system' warning message will appear on the cluster. If this occurs, we recommend that the vehicle be inspected by an authorized retailer of Genesis Branded products.

Limitations of Driver Attention Warning

Driver Attention Warning may not work properly in the following situations:

- The vehicle is driven violently
- The vehicle intentionally crosses over lanes frequently
- The vehicle is controlled by Driver Assistance system, such as Lane Keeping Assist

Leading vehicle departure alert function

- When the vehicle cuts in

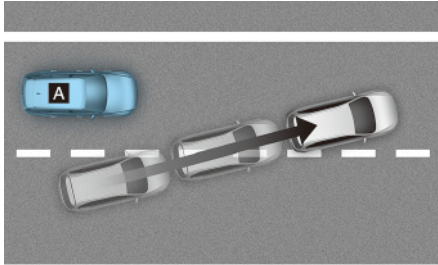

©ADAS021

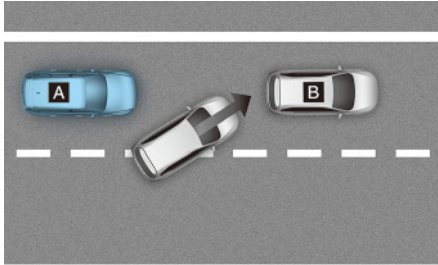

©ADAS022

[A] : Your vehicle, [B] : Front vehicle

If a vehicle cuts in front of your vehicle, Leading Departure Alert may not operate properly.

- When the vehicle ahead sharply steers

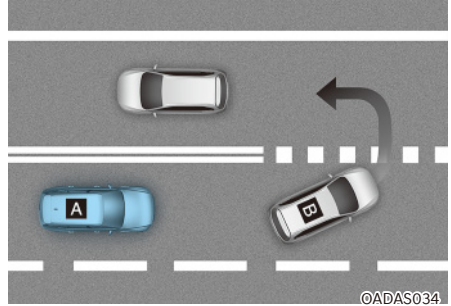

©ADAS034

[A] : Your vehicle, [B] : Front vehicle

If the vehicle in front makes a sharp turn, such as to turn left or right or make a U- turn, etc., Leading Vehicle Departure Alert may not operate properly.

- When the vehicle ahead abruptly departs

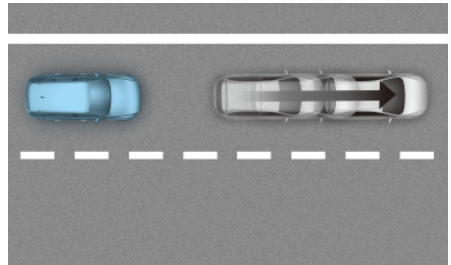

©ADAS024

If the vehicle in front abruptly departs, Leading Vehicle Departure Alert may not operate properly.

- When a pedestrian or bicycle is between you and the vehicle ahead

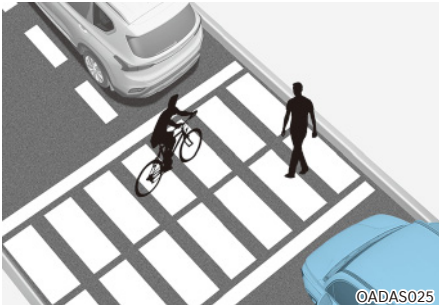

If there is a pedestrian(s) or bicycle(s) in between you and the vehicle in front, Leading Vehicle Departure Alert may not operate properly.

- When in a parking lot

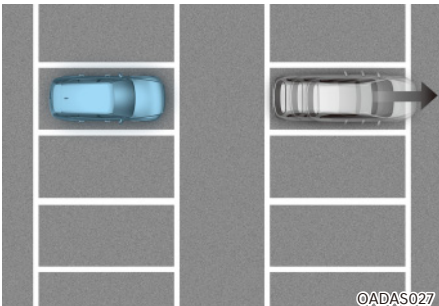

If a vehicle parked in front drives away from you, Leading Vehicle Departure Alert may alert you that the parked vehicle is driving away.

- When driving at a tollgate or intersection, etc.

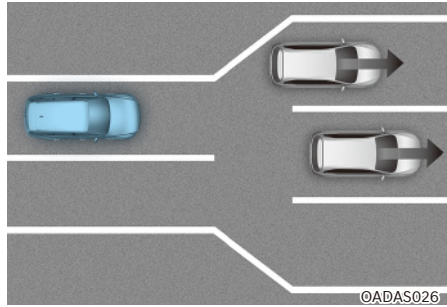

If you pass a tollgate or intersection with lots of vehicles or you drive where lanes are merged or divided frequently, Leading Vehicle Departure Alert may not operate properly.

i Information

For more details on the precautions of the front view camera, refer to “Forward Collision-Avoidance Assist (FCA)” section in this chapter.

FORWARD ATTENTION WARNING (FAW) (IF EQUIPPED)

Forward Attention Warning will warn the driver to help prevent the driver from being distracted while using the interior view camera installed in the instrument cluster.

Forward Attention Warning settings

Setting features

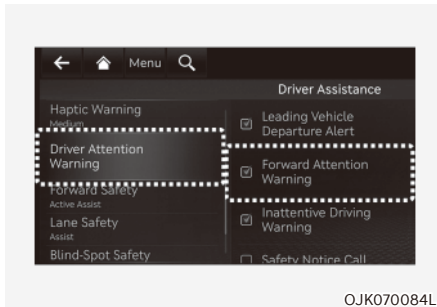

Forward Attention Warning

With the engine on, select 'Driver Assistance → Driver Attention Warning → Forward Attention Warning' from the Settings menu to turn on Forward Attention Warning and deselect to turn off the function.

WARNING

If the engine is restarted, Forward Attention Warning will maintain the last setting. If 'Off' is selected, the driver should always be aware of the surroundings and drive safely.

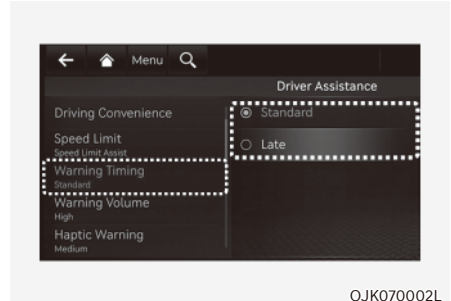

Warning Timing

With the engine on, select 'Driver Assistance → Warning Timing' from the Settings menu to change the initial warning activation time for Forward Attention Warning.

When the vehicle is first delivered, Warning Timing is set to 'Standard'. If you change the Warning Timing, the warning time of other Driver Assistance systems may change.

CAUTION

- Select 'Late' for Warning Timing when traffic is light and when driving speed is slow.
- While Smart Cruise Control or Highway Driving Assist is operating, Forward Attention Warning may warn later than the set warning time.

CAUTION

The setting of the Warning Timing applies to all functions of Forward Attention Warning.

Forward Attention Warning operation

Operating conditions

Forward Attention Warning will operate when the following conditions are satisfied:

- Vehicle speed is above 1 km/h (0.6 mph)
- The gear is in D (Drive) or N (Neutral)

Forward Attention Warning



Forward Attention Warning determines whether the driver is focused on the road depending on information, such as the amount of time the driver is looking elsewhere, the amount of time the eyes are closed, how frequently the driver yawns, etc. If Forward Attention Warning judges the driver is not focused, the 'Keep eyes on the road and drive careful' warning message will appear on the cluster, and an audible warning will sound.

WARNING

If any other system's warning message is displayed or audible warning is generated, Forward Attention Warning's warning message may not be displayed and audible warning may not be generated.

CAUTION

- Forward Attention Warning may warn the driver even though the driver is focused on the road due to driving style and driving pattern.
- Forward Attention Warning is a supplemental function and may not be able to determine whether the driver is distracted while driving.
- The driver should hold the responsibility to safely drive and focus on the road.

Information

Forward Attention Warning does not transmit recorded videos outside of the vehicle or store the video.

Forward Attention Warning malfunction and limitations

Forward Attention Warning malfunction



When Forward Attention Warning is not working properly, the 'Check Forward Attention Warning system' warning message will appear on the cluster. If this occurs, we recommend that the vehicle be inspected by an authorized retailer of Genesis Branded products.

Forward Attention Warning disabled

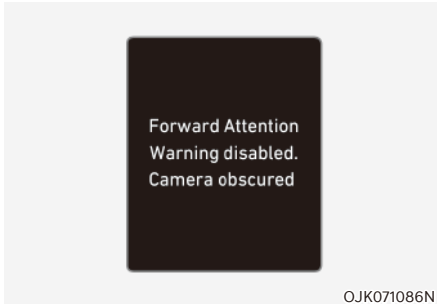

OJK071086N

When there is an object right in front of the camera or between the driver and the camera for a certain period of time, Forward Attention Warning will not operate properly, and the 'Forward Attention Warning disabled. Camera obscured' warning message will appear on the cluster.

After the warning message appears, if the object is removed, or Forward Attention Warning is able to detect the driver's face, the function will operate normally.

CAUTION

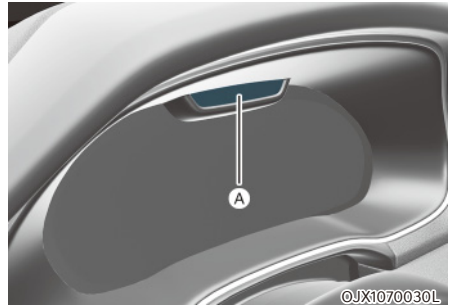

©JX1070030L

[A] : Interior view camera

- **Do not apply any impact on the surface of the instrument cluster, camera or around the area of the camera. If the interior view camera is damaged, Forward Attention Warning may not work properly.**
- **Do not place a mobile phone or an object in front of the camera. The surface of the instrument cluster or the camera might be damaged due to an impact while driving.**
- **Do not place anything on the camera or in front of the camera while driving. The interior view camera may not operate properly.**
- **If anything else is placed in front of the camera, Forward Attention Warning may not operate properly.**
- **When cleaning the instrument cluster or camera, wipe with a soft and clean cloth to prevent damages on the surface of the cluster or camera lens. In addition, you should not use sharp tools near the cluster or camera, or use chemicals to clean the cluster or camera.**
- **Always keep the camera and around the area of the interior view camera clean and dry.**
- **Do not apply foreign objects, such as a sticker, around the infrared LED located near the camera.**

i **Information**

Two red lights may appear on the camera in the following conditions when:

- The outside brightness is dim or driving at night
- The vehicle drives inside a building, such as a basement parking lot, garage or tunnel
- The camera case of the instrument cluster is partially broken

! **WARNING**

Do not look toward the camera within 20 cm (8 in.) for longer than a minute.

Limitations of Forward Attention Warning

Forward Attention Warning may be limited or may not operate properly in the following circumstances:

- The driver is wearing sunglasses, special glasses, infrared cutoff glasses, refracting glasses or thick glasses
- The driver has heavy eye makeup (eyeliner, mascara, color makeup, false eyelash) or eye piercing
- The driver's view is blocked by his/her hair, hat, etc.
- The driver is winking or wearing an eye patch on one eye
- The driver's face is covered partially by a mask, muffler, etc.
- The driver's view is blocked by incoming light from outside of the vehicle
- Light from outside, sunlight or infrared LED light of the camera is reflected by glasses or sunglasses
- The driver turns or lowers his/her head so that the face or an eye is hidden from the camera
- The camera is out of the range to monitor or close within 20 cm (8 in.)
- The driver shakes his/her head up and down, or adverse road conditions cause excessive vehicle vibrations while driving
- The driver is improperly positioned in the driver's seat so that the driver's face is not detected
- The driver is too tall or short
- The camera is blocked by the adjusted steering wheel height or the turned steering wheel
- More than two people are looking at the instrument cluster simultaneously from the driver's seat
- The driver's eyes are narrowed due to laughing or sun glare
- Misrecognize a picture or mannequin that has a similar size of the driver's face
- There are other devices using infrared light in the vehicle

BLIND-SPOT VIEW MONITOR (BVM) (IF EQUIPPED)

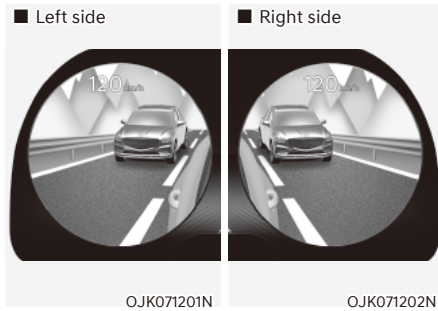

Blind-Spot View Monitor displays the rear blind spot area of the vehicle in the cluster when the turn signal is turned on to help safely change lanes.

Detecting sensor



[1], [2]: Surround-side view camera
(camera located at bottom of the mirror)

Refer to the picture above for the detailed location of the detecting sensors.

Blind-Spot View Monitor settings

Setting features

Blind-Spot View

With the engine on, select 'Driver Assistance → Blind-Spot Safety → Blind-Spot View' from the Settings menu to turn on Blind-Spot View Monitor and deselect to turn off the function.

Blind-Spot View Monitor operation

Operating switch

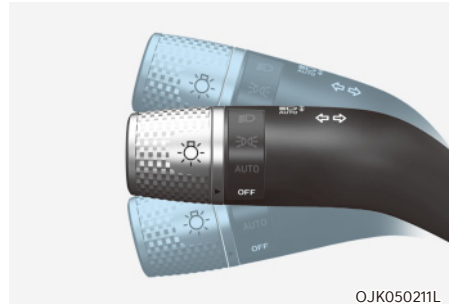

Turn signal lever

Blind-Spot View Monitor will turn on and off when the turn signal is turned on and off.

Blind-Spot View Monitor

Operating conditions

When the left or right side turn signal turns on, the image in that direction is displayed on the instrument cluster.

Off conditions

- When the turn signal turns off, the image on the instrument cluster will turn off.
- When the hazard warning flasher is on, Blind-Spot View Monitor will turn off, regardless of the turn signal status.
- When other important warning is displayed on the instrument cluster, Blind-Spot View Monitor may turn off.

Blind-Spot View Monitor malfunction

When Blind-Spot View Monitor is not working properly, or the cluster display flickers, or the camera image does not display normally, we recommend that the vehicle be inspected by an authorized retailer of Genesis Brand products.



WARNING

- **The image shown on the cluster may differ from the actual distance of the object. Make sure to directly check the vehicle's surroundings for safety.**
- **Always keep the camera lens clean. If the lens is covered with foreign material, it may adversely affect camera performance and Blind-Spot View Monitor may not operate normally.**

SMART CRUISE CONTROL (SCC) (IF EQUIPPED)

Smart Cruise Control is designed to detect the vehicle ahead and help maintain the desired speed and minimum distance between the vehicle ahead.

Overtaking Acceleration Assist

While Smart Cruise Control is operating, if the function judges that the driver is determined to overtake the vehicle in front, acceleration will be assisted.

Based on Driving Style (if equipped)

Smart Cruise Control will operate based on the driver's driving style, such as inter-vehicle distance, acceleration, reaction speed.

Detecting sensor

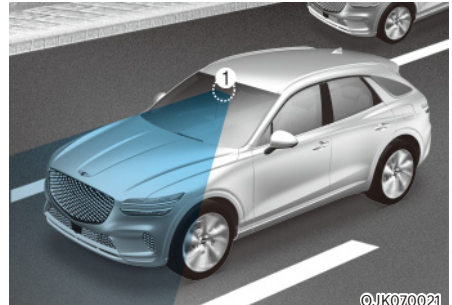

[1]: Front view camera, [2]: Front radar

The front view camera and front radar are used as a detecting sensor to detect front vehicles.

Refer to the picture above for the detailed location of the detecting sensor.



CAUTION

Always keep the front view camera and front radar in good condition to maintain optimal performance of Smart Cruise Control.

For more details on the precautions of the front view camera and front radar, refer to “Forward Collision-Avoidance Assist (FCA)” section in this chapter.

Smart Cruise Control settings

Setting features

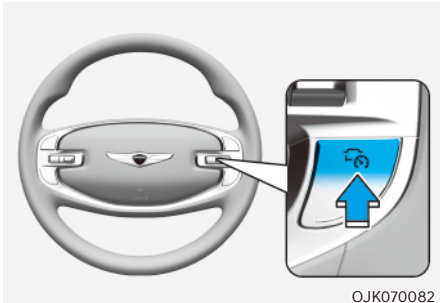

To turn on Smart Cruise Control

- Press the Driving Assist (Ⓜ) button to turn on Smart Cruise Control. The speed will be set to the current speed on the cluster.
- If there is no vehicle in front of you, the set speed will be maintained, but if there is a vehicle in front of you, the speed may decrease to maintain the distance to the vehicle ahead. If the vehicle ahead accelerates, your vehicle will travel at a steady cruising speed after accelerating to the set speed.

i Information

If your vehicle speed is between 0~ 30 km/h (0~ 20 mph) when you press the Driving Assist (Ⓜ) button, the Smart Cruise Control speed will be set to 30 km/h (20 mph).

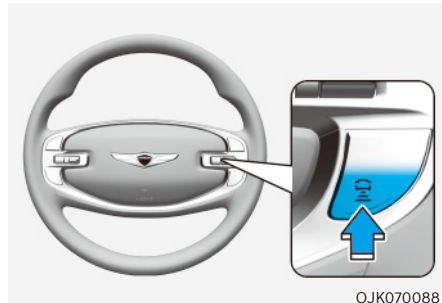

To set vehicle distance

Each time the button is pressed, the headway changes as follows:

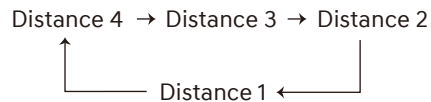

i Information

- If you drive at 90 km/h (56 mph), the distance is maintained as follows:
 - Distance 4 - approximately 53 m (172 ft.)
 - Distance 3 - approximately 40 m (130 ft.)
 - Distance 2 - approximately 30 m (106 ft.)
 - Distance 1 - approximately 25 m (82 ft.)
- The distance is set to the last set distance when the engine is restarted, or when Smart Cruise Control was temporarily canceled.

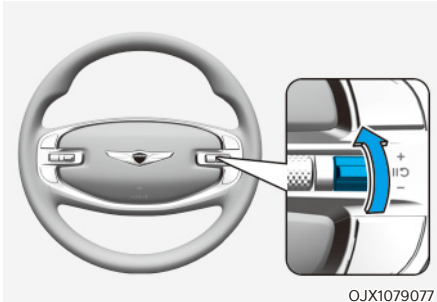

OJX1079077

To increase speed

- Push the + switch up and release it immediately. The cruising speed will increase by 1 km/h (1 mph) each time the switch is operated in this manner.
- Push the + switch up and hold it while monitoring the set speed on the cluster. The cruising speed will increase by 10 km/h or 5 mph each time the switch is operated in this manner. Release the switch when the desired speed is shown, and the vehicle will accelerate to that speed. You can set the speed to 200 km/h (120 mph).



WARNING

Check the driving condition before using the + switch. Driving speed may sharply increase when you push up and hold the + switch.

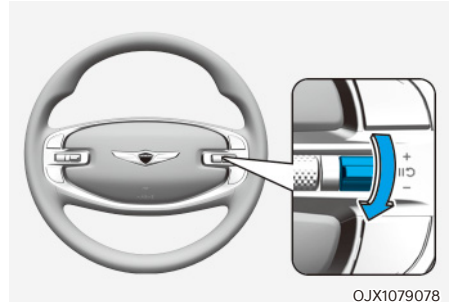

OJX1079078

To decrease speed

- Push the - switch down and release it immediately. The cruising speed will decrease by 1 km/h (1 mph) each time the switch is operated in this manner.
- Push the - switch down and hold it while monitoring the set speed on the cluster. The cruising speed will decrease by 10 km/h or 5 mph each time the switch is operated in this manner.

Release the switch at the speed you want to maintain. You can set the speed to 30 km/h (20 mph).

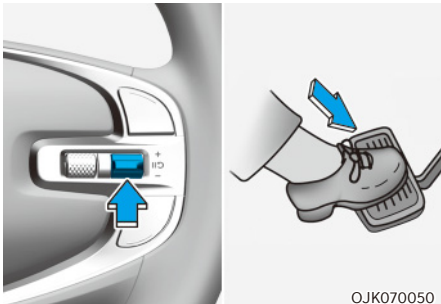

To temporarily cancel Smart Cruise Control

Press the switch or depress the brake pedal to temporarily cancel Smart Cruise Control.

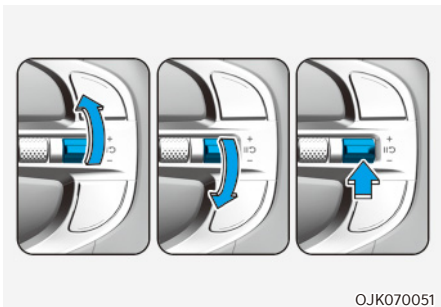

To resume Smart Cruise Control

To resume Smart Cruise Control after the function was canceled, push the +, - or switch.

If you push the + switch up or - switch down, vehicle speed will be set to the current speed on the cluster.

If you push the switch, vehicle speed will resume to the preset speed.

⚠ WARNING

Check the driving condition before using the switch. Driving speed may sharply increase or decrease when you press the switch.

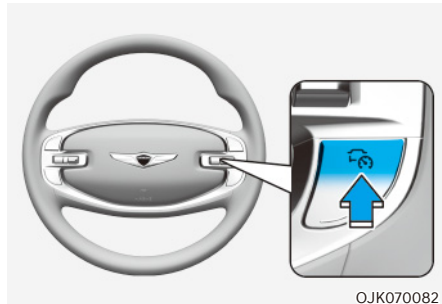

To turn off Smart Cruise Control

Press the Driving Assist () button to turn Smart Cruise Control off.

i Information

If your vehicle is equipped with Manual Speed Limit Assist, press and hold the Driving Assist () button to turn off Smart Cruise Control. However Manual Speed Limit Assist will turn on.

Based on Drive Mode

Smart Cruise Control will change acceleration based on the drive mode selected from Drive Mode Integrated Control system. Refer to the following chart.

Drive mode	Smart Cruise Control
COMFORT	Normal
ECO	Slow
SPORT	Fast
SMART (if equipped)	Normal
CUSTOM (if equipped)	Based on selected Powertrain mode

i Information

For more details on drive mode, refer to “Drive Mode Integrated Control System” section in chapter 6.

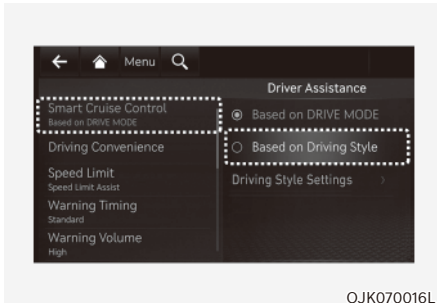

OJK070016L

Based on Driving Style (if equipped)

- With the engine on, if 'Driver Assistance → Smart Cruise Control → Based on Driving Style' is selected from the Settings menu, Smart Cruise Control will operate based on the driver's driving style, such as vehicle distance, acceleration, reaction speed.
- While Smart Cruise Control is operating with 'Based on Drive Mode' selected, if you press and hold the Vehicle Distance (Ⓛ) button, Smart Cruise Control will change to 'Based on Driving Style'. While Smart Cruise Control is operating with 'Based on Driving Style', if the Vehicle Distance (Ⓛ) button is shortly pressed, it will change to 'Based on Drive Mode'.

i Information

- **If equipped with Based on Driving Style, 'Based on Drive mode' and 'Based on Driving Style' can be selected from the settings menu by selecting 'Driver Assistance → Smart Cruise Control'.**
- **If 'Based on Drive mode' is selected, Smart Cruise Control will operate based on the drive mode selected.**

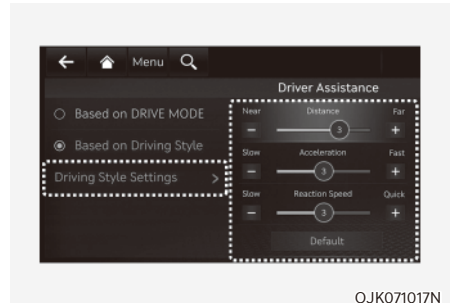

OJK071017N

Driving Style Settings (if equipped)

With the engine on, select 'Driver Assistance → Smart Cruise Control → Driving Style Settings' from the Settings menu to check the driver's driving style, and to change each driving style manually.

i Information

- **'Driving Style Settings' is displayed when 'Based on Driving Style' is selected.**
- **Smart Cruise Control learns the driver's driving styles only when the driver drives the vehicle.**

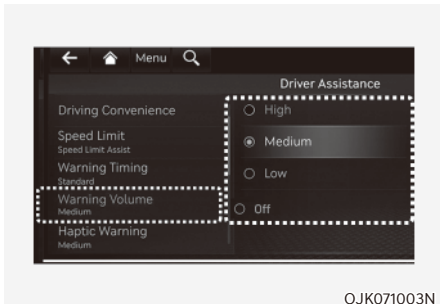

Warning Volume

With the engine on, select 'Driver Assistance → Warning volume' or 'Sound → Driver Assist Warning → Warning Volume' from the Settings menu to change the Warning Volume 'High', 'Medium' or 'Low' for Smart Cruise Control.

However, even if 'Off' is selected, the Warning Volume of Smart Cruise Control will not turn off but the volume will sound as 'Low'.

If you change the Warning Volume, the warning volume of other Driver Assistance systems may change.

i Information

If the engine is restarted, Warning Volume will maintain the last setting.

Smart Cruise Control operation

Operating conditions

Smart Cruise Control operates when the following conditions are satisfied.

Basic function

- The gear is in D (Drive)
- The driver's door is closed
- EPB (Electronic Parking Brake) is not applied
- Your vehicle speed is within the operating speed range
 - 10~200 km/h (5~120 mph): when there is no vehicle in front
 - 0~200 km/h (0~120 mph): when there is a vehicle in front
- ESC (Electronic Stability Control) or ABS is on
- ESC (Electronic Stability Control) or ABS is not controlling the vehicle
- Engine RPM is not in the red zone
- Forward Collision-Avoidance Assist brake control is not operating
- Remote Smart Parking Assist brake control is not operating (if equipped)
- ISG system is not operating
- Hands-off warning for Lane Keeping Assist and Highway Driving Assist is off

i Information

At a stop, if there is no vehicle in front of your vehicle, Smart Cruise Control turns on when the brake pedal is depressed

Overtaking Acceleration Assist

Overtaking Acceleration Assist operates when the turn signal indicator is turned on to the left (left-hand drive) or turned on to the right (right-hand drive) while Smart Cruise Control is operating, and the following conditions are satisfied:

- Your vehicle speed is above 60 km/h (40 mph)
- The hazard warning flasher is off
- A vehicle is detected in front of your vehicle
- Deceleration is not needed to maintain distance with the vehicle in front



WARNING

- **When the turn signal indicator is turned on to the left (left-hand drive) or turned on to the right (right-hand drive) while there is a vehicle ahead, the vehicle may accelerate temporarily. Pay attention to the road conditions at all times.**
- **Regardless of your countries driving direction, Overtaking Acceleration Assist will operate when the conditions are satisfied. When using the function in countries with different driving direction, always check the road conditions at all times.**

Display and control

Basic function

You can see the status of the Smart Cruise Control operation in the Driving Assist view on the cluster. Refer to “View Modes” section in chapter 4.

Smart Cruise Control will be displayed as below depending on the status of the function.

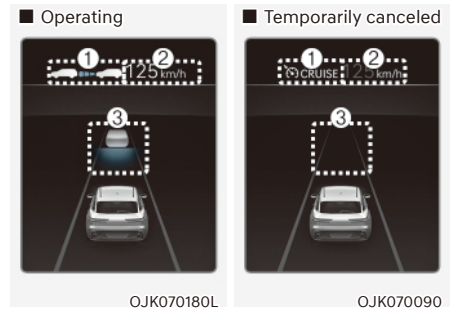

- When operating
 - (1) Whether there is a vehicle ahead and the selected distance level are displayed.
 - (2) Set speed is displayed.
 - (3) Whether there is a vehicle ahead and the target vehicle distance are displayed.
- When temporarily canceled
 - (1) CRUISE indicator is displayed.
 - (2) The previous set speed is shaded.
 - (3) Vehicle ahead and distance level not displayed

i Information

- The distance of the front vehicle on the cluster is displayed according to the actual distance between your vehicle and the vehicle ahead.
- The target distance may vary according to the vehicle speed and the set distance level. If vehicle speed is low, even though the vehicle distance have changed, the change of the target vehicle distance may be small.

Accelerating temporarily



If you want to speed up temporarily without altering the set speed while Smart Cruise Control is operating, depress the accelerator pedal. While the accelerator pedal is depressed, the set speed, distance level and target distance will blink on the cluster.

However, if the accelerator pedal is depressed insufficiently, the vehicle may decelerate.

! WARNING

Be careful when accelerating temporarily, because the speed and distance is not controlled automatically even if there is a vehicle in front of you.

Based on Driving Style operating

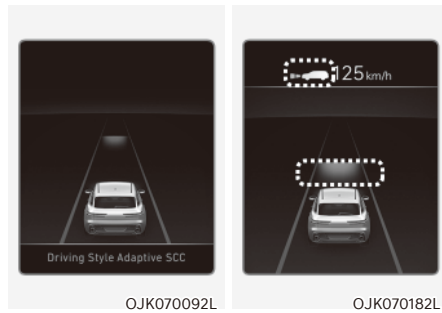

When Based on Driving Style is operating, 'Driving Style Adaptive SCC' message will appear on the cluster for 2 seconds, and the distance level and target distance will be displayed based on the driving style.

Smart Cruise Control temporarily canceled

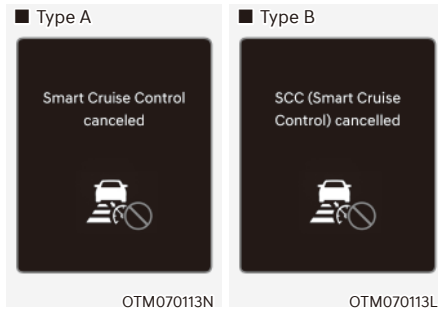

Smart Cruise Control will be temporarily canceled automatically when:

- The vehicle speed is above 210 km/h (130 mph)
- The vehicle is stopped for a certain period of time
- The accelerator pedal is continuously depressed for a certain period of time
- The conditions for the Smart Cruise Control to operate is not satisfied

If Smart Cruise Control is temporarily canceled automatically, the 'Smart Cruise Control canceled' (or 'SCC (Smart Cruise Control) cancelled') warning message will appear on the cluster, and an audible warning will sound to warn the driver.

If Smart Cruise Control is temporarily canceled while the vehicle is at a standstill with the function activated, EPB (Electronic Parking Brake) maybe applied.



WARNING

When Smart Cruise Control is temporarily canceled, distance with the front vehicle will not be maintained. Always have your eyes on the road while driving, and if necessary, depress the brake pedal to reduce your driving speed in order to maintain a safe distance.

Smart Cruise Control conditions not satisfied

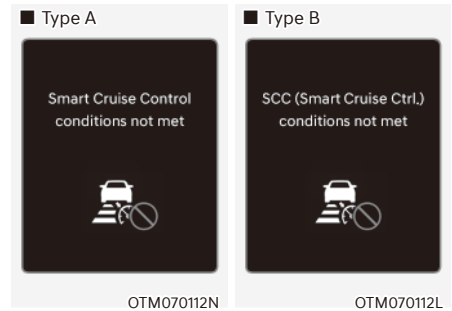

If the Driving Assist button, + switch, - switch or  switch is pushed when Smart Cruise Control operating conditions are not satisfied, the 'Smart Cruise Control conditions not met' (or 'SCC (Smart Cruise Ctrl. conditions not met') will appear on the cluster, and an audible warning will sound.

In traffic situation

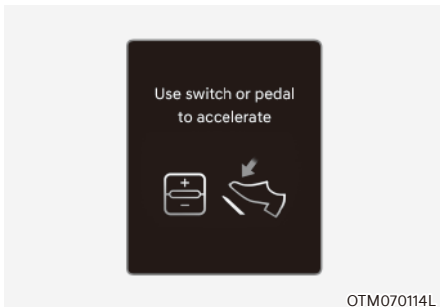

In traffic, your vehicle will stop if the vehicle ahead of you stops. Also, if the vehicle ahead of you starts moving, your vehicle will start as well. In addition, after the vehicle has stopped and a certain time have passed, the 'Use switch or pedal to accelerate' message will appear on the cluster. Depress the accelerator pedal or push the + switch, - switch or II C switch to start driving.

Warning road conditions ahead

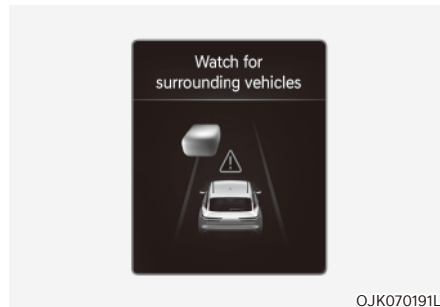

In the following situation, the 'Watch for surrounding vehicles' warning message will appear on the cluster, and an audible warning will sound to warn the driver of road conditions ahead.

- The vehicle in front disappears when Smart Cruise Control is maintaining the distance with the vehicle ahead while driving below a certain speed.
- While the 'Use switch or pedal to accelerate' message is displayed on the cluster, if there is no vehicle in front or the vehicle is far away from you, and the + switch, - switch or II C switch is pushed.

WARNING

Always pay attention to vehicles or objects that may suddenly appear in front of you, and if necessary, depress the brake pedal to reduce your driving speed in order to maintain a safe distance.

Collision Warning



While Smart Cruise Control is operating, when the collision risk with the vehicle ahead is high, the 'Collision Warning' warning message will appear on the cluster, and an audible warning will sound to warn the driver. Always have your eyes on the road while driving, and if necessary, depress the brake pedal to reduce your driving speed in order to maintain a safe distance.

WARNING

In the following situations, Smart Cruise Control may not warn the driver of a collision.

- The distance from the front vehicle is near, or the vehicle speed of the front vehicle is faster or similar with your vehicle
- The speed of the front vehicle is very slow or is at a standstill
- The accelerator pedal is depressed right after Smart Cruise Control is turned on

WARNING

Take the following precautions when using Smart Cruise Control:

- Smart Cruise Control does not substitute for proper and safe driving. It is the responsibility of the driver to always check the speed and distance to the vehicle ahead.
- Smart Cruise Control may not recognize unexpected and sudden situations or complex driving situations, so always pay attention to driving conditions and control your vehicle speed.
- Keep Smart Cruise Control off when the function is not in use to avoid inadvertently setting a speed.
- Do not open the door or leave the vehicle when Smart Cruise Control is operating, even if the vehicle is stopped.
- Always be aware of the selected speed and headway distance.
- Keep a safe distance according to road conditions and vehicle speed. If the headway distance is too close during high-speed driving, a serious collision may result.

- When maintaining distance with the vehicle ahead, if the front vehicle disappears, Smart Cruise Control may suddenly accelerate to the set speed. Always be aware of unexpected and sudden situations from occurring.
- Vehicle speed may decrease on an upward slope and increase on a downward slope.
- Always be aware of situations such as when a vehicle cuts in suddenly.
- When you turn off Smart Cruise Control for safety reasons.
- Turn off Smart Cruise Control when your vehicle is being towed.
- Smart Cruise Control may not operate normally if interfered by strong electromagnetic waves.
- Smart Cruise Control may not detect an obstacle in front and lead to a collision. Always look ahead cautiously to prevent unexpected and sudden situations from occurring.
- Vehicles moving in front of you with a frequent lane change may cause a delay in Smart Cruise Control reaction or may cause Smart Cruise Control to react to a vehicle actually in an adjacent lane. Always drive cautiously to prevent unexpected and sudden situations from occurring.
- Always be aware of the surroundings and drive safely, even though a warning message does not appear or an audible warning does not sound.
- If any other system's warning message is displayed or warning sound is generated, Smart Cruise Control warning message may not be displayed and warning sound may not be generated.
- You may not hear the warning sound of Forward Collision-Avoidance Assist if the surrounding is noisy.
- The vehicle manufacturer is not responsible for any traffic violation or accidents caused by the driver.
- Always set the vehicle speed under the speed limit in your country.
- Vehicle distance, acceleration and reaction speed may change if the driver's driving style changes.



CAUTION

- The vehicle must be driven sufficiently to reflect the actual driving style of the driver, such as inter-vehicle distance, acceleration and reaction speed.
- Based on Driving style does not reflect whether the driver has changed when determining the driver's driving style.
- If you are driving in special conditions, such as snow, rain, fog or steep slopes, the vehicle may not be driven according to the driver's driving style.





Information

- Smart Cruise Control may not operate for 15 seconds after the vehicle is started or the front view camera or front radar is initialized.
- You may hear a sound when the brake is controlled by Smart Cruise Control.
- Based on Driving Style may not reflect the driver's driving style or driving conditions that affects driving safety.
- Based on Driving Style does not reflect any other driving style other than inter-vehicle distance, acceleration and reaction speed.

Smart Cruise Control malfunction and limitations

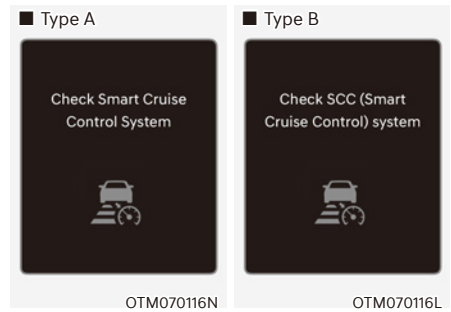
Smart Cruise Control malfunction



When Smart Cruise Control is not working properly, the 'Check Smart Cruise Control system' (or 'Check SCC (Smart Cruise Control) system') warning message will appear, and the  warning light will illuminate on the cluster. We recommend that the vehicle be inspected by an authorized retailer of Genesis Branded products.

Smart Cruise Control disabled

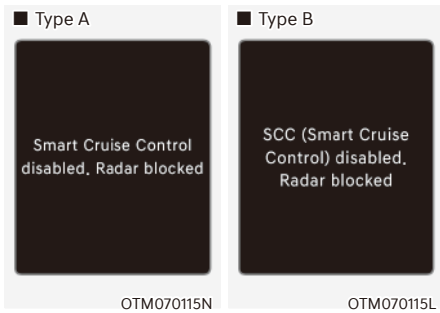

When the front radar cover or sensor is covered with snow, rain, or foreign material, it can reduce the detecting performance and temporarily limit or disable Smart Cruise Control.

If this occurs the 'Smart Cruise Control disabled. Radar blocked' (or 'SCC (Smart Cruise Control) disabled. Radar blocked') warning message will appear for a certain period of time on the cluster.

Smart Cruise Control will operate normally when snow, rain or foreign material is removed.

WARNING

Even though the warning message does not appear on the cluster, Smart Cruise Control may not properly operate.

CAUTION

Smart Cruise Control may not properly operate in an area (for example, open terrain), where there is nothing to detect after turning ON the engine.

Limitations of Smart Cruise Control

Smart Cruise Control may not operate normally, or it may operate unexpectedly under the following circumstances:

- The detecting sensor or the surroundings are contaminated or damaged
- Washer fluid is continuously sprayed, or the wiper is on
- The camera lens is contaminated due to tinted, filmed or coated windshield, damaged glass, or sticky foreign material (sticker, bug, etc.) on the glass
- Moisture is not removed or frozen on the windshield
- The field of view of the front view camera is obstructed by sun glare
- Street light or light from an oncoming vehicle is reflected on the wet road surface, such as a puddle on the road
- The temperature around the front view camera is high or low
- An object is placed on the dashboard
- The surrounding is very bright
- The surrounding is very dark, such as in a tunnel, etc.
- The brightness changes suddenly, for example when entering or exiting a tunnel
- The brightness outside is low, and the headlamps are not on or are not bright
- Driving in heavy rain or snow, or thick fog
- Driving through steam, smoke or shadow

- Only part of the vehicle is detected
- The vehicle in front has no tail lights, tail lights are located unusually, etc.
- The brightness outside is low, and the tail lamps are not on or are not bright
- The rear of the front vehicle is small or does not look normal (for example, tilted, overturned, etc.)
- The front vehicle's ground clearance is low or high
- A vehicle suddenly cuts in front
- Your vehicle is being towed
- Driving through a tunnel or iron bridge
- Driving near areas containing metal substances, such as a construction zone, railroad, etc.
- A material is near that reflects very well on the front radar, such as a guardrail, nearby vehicle, etc.
- The bumper around the front radar is impacted, damaged or the front radar is out of position
- The temperature around the front radar is high or low
- Driving in large areas where there are few vehicles or structures (for example, desert, meadow, suburb, etc.)
- The vehicle in front is made of material that does not reflect on the front radar
- Driving near a highway (or motorway) interchange or tollgate
- Driving on a slippery surface due to snow, water puddle, ice, etc.
- Driving on a curved road
- The vehicle in front is detected late
- The vehicle in front is suddenly blocked by an obstacle
- The vehicle in front suddenly changes lane or suddenly reduces speed
- The vehicle in front is bent out of shape
- The front vehicle's speed is fast or slow
- With a vehicle in front, your vehicle changes lane at low speed
- The vehicle in front is covered with snow
- Unstable driving
- You are on a roundabout and the vehicle in front is not detected
- You are continuously driving in a circle
- Driving in a parking lot
- Driving through a construction area, unpaved road, partial paved road, uneven road, speed bumps, etc.
- Driving on an incline road, curved road, etc.
- Driving through a roadside with trees or streetlights
- The adverse road conditions cause excessive vehicle vibrations while driving
- Your vehicle height is low or high due to heavy loads, abnormal tire pressure, etc.
- Driving through a narrow road where trees or grass are overgrown
- There is interference by electromagnetic waves, such as driving in an area with strong radio waves or electrical noise

- Driving on a curved road

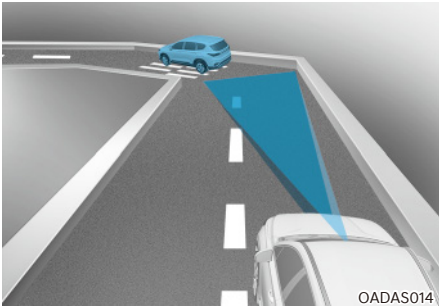

On curves, Smart Cruise Control may not detect a vehicle in the same lane, and may accelerate to the set speed. Also, vehicle speed may rapidly decrease when the vehicle ahead is detected suddenly.

Select the appropriate set speed on curves and apply the brake pedal or accelerator pedal according to the road and driving conditions ahead.

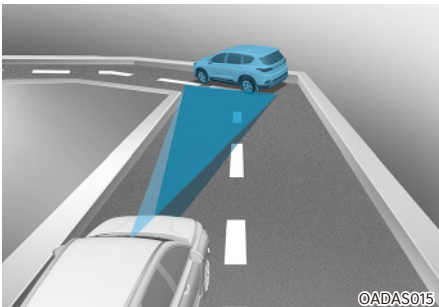

Your vehicle speed can be reduced due to a vehicle in the adjacent lane.

Apply the accelerator pedal and select the appropriate set speed. Check to be sure that the road conditions permit safe operation of the Smart Cruise Control.

- Driving on an inclined road

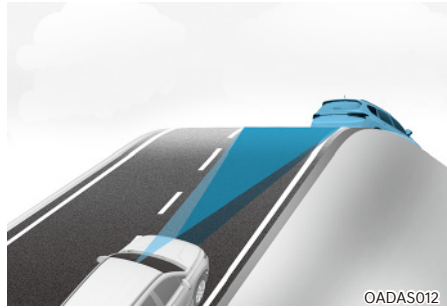

During uphill or downhill driving, the Smart Cruise Control may not detect a moving vehicle in your lane, and cause your vehicle to accelerate to the set speed. Also, vehicle speed will rapidly decrease when the vehicle ahead is detected suddenly.

Select the appropriate set speed on inclines and apply the brake pedal or accelerator pedal according to the road and driving conditions ahead.

- Changing lanes



[A] : Your vehicle, [B] : Lane changing vehicle

When a vehicle moves into your lane from an adjacent lane, it cannot be detected by the sensor until it is in the sensor's detection range. Smart Cruise Control may not immediately detect the vehicle when the vehicle changes lanes abruptly. In this case, you must maintain a safe braking distance, and if necessary, depress the brake pedal to reduce your driving speed in order to maintain a safe distance.

- Detecting vehicle

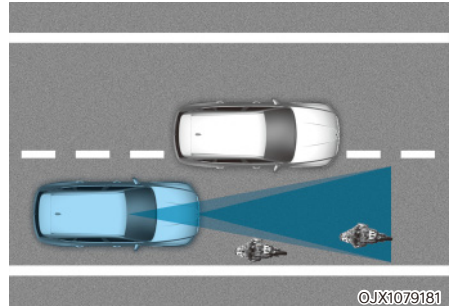

In the following cases, some vehicles in your lane cannot be detected by the sensor:

- Vehicles offset to one side
- Slow-moving vehicles or sudden-decelerating vehicles
- Oncoming vehicles
- Stopped vehicles
- Vehicles with small rear profile, such as trailers
- Narrow vehicles, such as motorcycles or bicycles
- Special vehicles
- Animals and pedestrians

Adjust your vehicle speed by depressing the brake pedal according to the road and driving conditions ahead.

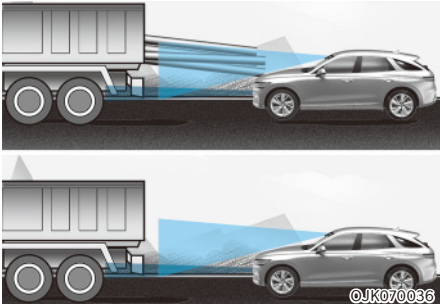

In the following cases, the vehicle in front cannot be detected by the sensor:

- Vehicles with higher ground clearance or vehicles carrying loads that stick out of the back of the vehicle
- Vehicles that has the front lifted due to heavy loads
- You are steering your vehicle
- Driving on narrow or sharply curved roads

Adjust your vehicle speed by depressing the brake pedal according to the road and driving conditions ahead.

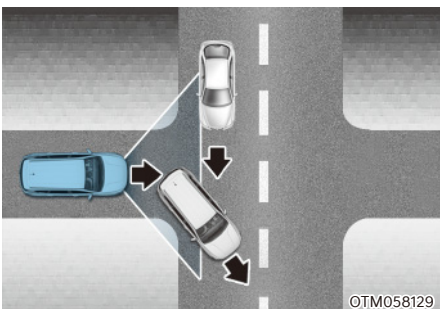

- When a vehicle ahead disappears at an intersection, your vehicle may accelerate.

Always pay attention to road and driving conditions while driving.

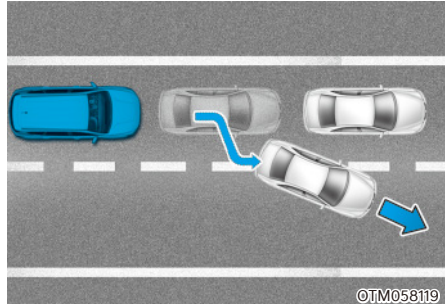

- When a vehicle in front of you merges out of the lane, Smart Cruise Control may not immediately detect the new vehicle that is now in front of you. Always pay attention to road and driving conditions while driving.

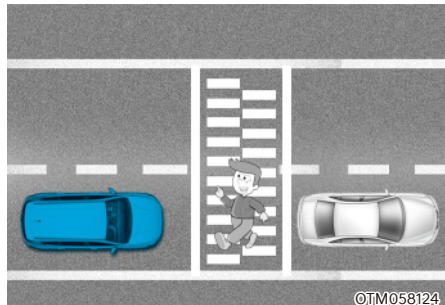

- Always look out for pedestrians when your vehicle is maintaining a distance with the vehicle ahead.

NAVIGATION-BASED SMART CRUISE CONTROL (NSCC) (IF EQUIPPED)

Navigation-based Smart Cruise Control helps drive at a safe speed according to the road conditions when driving on highways (or motorways) by using road information from the navigation system while Smart Cruise Control is operating.

i Information

- **The Navigation-based Smart Cruise Control is available only on controlled access road of certain highways.**
 - * **Controlled access road indicates roads with limited entrances and exits that allow uninterrupted high speed traffic flow. Only passenger cars and motorcycles are allowed on controlled access roads.**
- **Additional highways may be expanded by future navigation updates.**

i Information

Navigation-based Smart Cruise Control operates on main roads of highways (or motorways), and does not operate on interchanges or junctions.

Highway Curve Zone Auto Slowdown

If vehicle speed is high, Highway Curve Zone Auto Slowdown function will temporarily decelerate your vehicle or limit acceleration to help you drive safely on a curve based on the curve information from the navigation.

Highway Set Speed Auto Change

Highway Set Speed Auto Change function automatically changes Smart Cruise Control set speed based on the speed limit information from the navigation.

Navigation-based Smart Cruise Control settings

Setting features

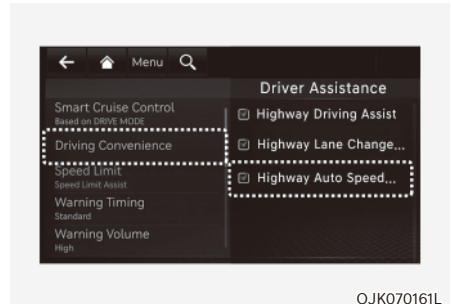

With the engine on, select 'Driver Assistance → Driving Assist → Highway Auto Speed Change' from the Settings menu to turn on Navigation-based Smart Cruise Control and deselect to turn off the function.

Highway Curve Zone Auto Slowdown

With the engine on, select 'Driver Assistance → Driving Convenience → Highway Auto Curve Slowdown' from the Settings menu to turn on Highway Curve Zone Auto Slowdown and deselect to turn off the function.

i Information

When there is a problem with Navigation-based Smart Cruise Control, the function cannot be set from the Settings menu.

Navigation-based Smart Cruise Control operation

Operating conditions

Navigation-based Smart Cruise Control is ready to operate if all of the following conditions are satisfied:

- Smart Cruise Control is operating
- Driving on main roads of highways (or motorways)

Information

For more details on how to operate Smart Cruise Control, refer to “Smart Cruise Control (SCC)” section in this chapter.

Navigation-based Smart Cruise Control display and control

When Navigation-based Smart Cruise Control operates, it will be displayed on the cluster as follows:

- Navigation-based Smart Cruise Control standby



If the operating conditions are satisfied, the white **NAV** indicator will illuminate.

- Navigation-based Smart Cruise Control operating

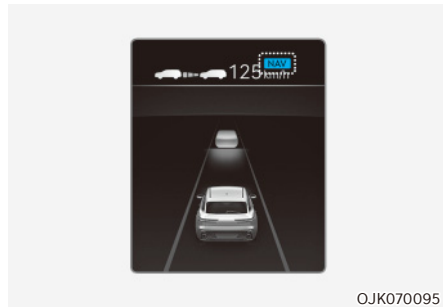

If temporary deceleration is required in the standby state and Navigation-based Smart Cruise Control is operating, the green **NAV** symbol will illuminate on the cluster.

If the Highway Set Speed Auto Change function operates, the **NAV** symbol and set speed will illuminate in green on the cluster, and an audible warning will sound.



WARNING



'Drive carefully' warning message will appear in the following circumstances:

- Navigation-based Smart Cruise Control is not able to slow down your vehicle to a safe speed



Information



Highway Curve Zone Auto Slowdown and Highway Set Speed Auto Change function uses the same **NAV** symbol.

Highway Curve Zone Auto Slowdown

- Depending on the curve ahead on the highway (or motorway), the vehicle will decelerate, and after passing the curve, the vehicle will accelerate to Smart Cruise Control set speed.
- Vehicle deceleration time may differ depending on the vehicle speed and the degree of the curve on the road. The higher the driving speed, deceleration will start faster.

Highway Set Speed Auto Change

- Highway Set Speed Auto Change function will operate when Smart Cruise Control set speed and the highway (or motorway) speed limit is matched.
- While Highway Set Speed Auto Change function is operating, when the highway (or motorway), speed limit changes, Smart Cruise Control set speed automatically changes to the changed speed limit.
- If Smart Cruise Control set speed is adjusted different from the speed limit, Highway Set Speed Auto Change function will be in the standby state.
- If Highway Set Speed Auto Change function has changed to the standby state by driving on a road other than the highway (or motorway) main road, Highway Set Speed Auto Change function will operate again when you drive on the main road again without setting the set speed.

- If Highway Set Speed Auto Change function has changed to the standby state by depressing the brake pedal or pressing the  switch on the steering wheel, press the  switch to restart the function.
- Highway Set Speed Auto Change function does not operate on highway interchanges or junctions.

Information

- **Highway Set Speed Auto Change function only operates based on the speed limits of the highway (or motorway), it does not work with the speed cameras.**
- **When Highway Set Speed Auto Change function is operating, the vehicle automatically accelerates or decelerates when the highway (or motorway) speed limit changes.**
- **The maximum set speed for Highway Set Speed Auto Change function is 140 km/h (86 mph).**
- **If the speed limit of a new road is not updated in the navigation, Highway Set Speed Auto Change function may not operate properly.**
- **If the speed unit is set to a unit other than the speed unit used in your country, Highway Set Speed Auto Change function may not operate properly.**

Limitations of Navigation-based Smart Cruise Control

Navigation-based Smart Cruise Control may not operate normally under the following circumstances:

- The navigation is not working properly
- Map information is not transmitted due to infotainment system's abnormal operation
- Speed limit and road information in the navigation is not updated
- The map information and the actual road is different because of real-time GPS data or map information error
- The navigation searches for a route while driving
- GPS signals are blocked in areas such as a tunnel
- A road that divides into two or more roads and joins again

- The driver goes off course the route set in the navigation
- The route to the destination is changed or canceled by resetting the navigation
- The vehicle enters a service station or rest area
- Android Auto or Car Play is operating
- The navigation cannot detect the current vehicle position (for example, elevated roads including overpass adjacent to general roads or nearby roads exist in a parallel way)
- The navigation is being updated while driving
- The navigation is being restarted while driving
- The speed limit of some sections changes according to the road situations
- Driving on a road under construction
- Driving on a road that is controlled
- There is bad weather, such as heavy rain, heavy snow, etc.
- Driving on a road that is sharply curved

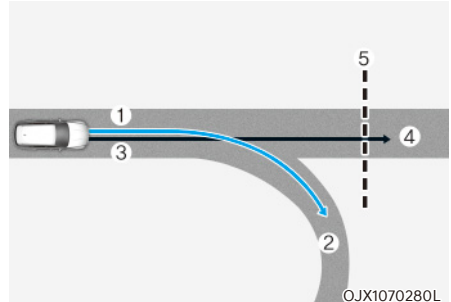

[1] : Set route, [2] : Branch line, [3] : Driving route, [4] : Main road, [5] : Curved road section

- When there is a difference between the navigation set route (branch line) and the driving route (main road), Highway Curve Zone Auto Slowdown function may not operate until the driving route is recognized as the main road.
- When the vehicle's driving route is recognized as the main road by maintaining the main road instead of the navigation set route, Highway Curve Zone Auto Slowdown function will operate. Depending on the distance to the curve and the current vehicle speed, vehicle deceleration may not be sufficient or may decelerate rapidly.

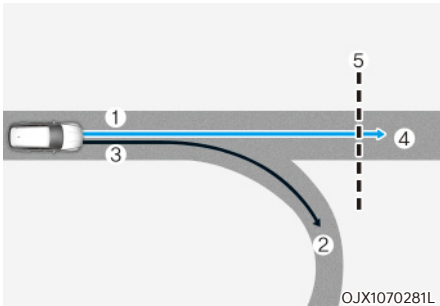

[1] : Set route, [2] : Branch line, [3] : Driving route, [4] : Main road, [5] : Curved road section

- When there is a difference between the navigation route (main road) and the driving route (branch line), Highway Curve Zone Auto Slowdown function will operate based on the curve information on the main road.
- When it is judged that you are driving out of the route by entering the highway interchange or junction, Highway Curve Zone Auto Slowdown function will not operate.

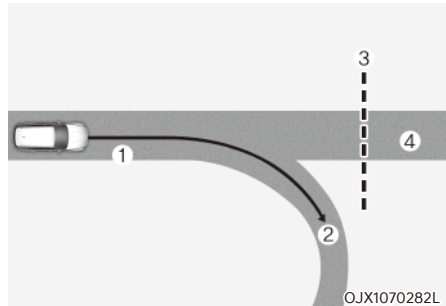

[1] : Driving route, [2] : Branch line, [3] : Curved road section, [4] : Main road

- If there is no destination set on the navigation, Highway Curve Zone Auto Slowdown function will operate based on the curve information on the main road.
- Even if you depart from the main road, Highway Curve Zone Auto Slowdown function may temporarily operate due to navigation information of the highway curve section.



WARNING

- Navigation-based Smart Cruise Control is not a substitute for safe driving practices, but a convenience function. Always have your eyes on the road, and it is the responsibility of the driver to avoid violating traffic laws.
- The navigation's speed limit information may differ from the actual speed limit information on the road. It is the driver's responsibility to check the speed limit on the actual driving road or lane.
- Navigation-based Smart Cruise Control will automatically be cancelled when you leave the highway (or motorway) main road. Always pay attention to road and driving conditions while driving.
- Navigation-based Smart Cruise Control may not operate due to the existence of leading vehicles and the driving conditions of the vehicle. Always pay attention to road and driving conditions while driving.
- When you are towing a trailer or another vehicle, turn off Navigation-based Smart Cruise Control for safety reasons.
- After you pass through a tollgate on a highway (or motorway), Navigation-based Smart Cruise Control will operate based on the first lane. If you enter one of the other lanes, Navigation-based Smart Cruise Control might not operate properly.
- The vehicle will accelerate if the driver depresses the accelerator pedal while Navigation-based Smart Cruise Control is operating, and the function will not decelerate the vehicle. However, if the accelerator pedal is depressed insufficiently, the vehicle may decelerate.

- If the driver accelerates and releases the accelerator pedal while Navigation-based Smart Cruise Control is operating, the vehicle may not decelerate sufficiently or may rapidly decelerate to a safe speed.
- If the curve is too large or too small, Navigation-based Smart Cruise Control may not operate.



Information

- A time gap could occur between the navigation's guidance and when Navigation-based Smart Cruise Control operation starts and ends.
- The speed information on the cluster and navigation may differ.
- Even if you are driving at a speed lower than Smart Cruise Control set speed, acceleration may be limited by the curve sections ahead.
- If Navigation-based Smart Cruise Control is operating while leaving the main road to enter an interchange, junction, rest area, etc., the function may operate for a certain period of time.
- Deceleration by Navigation-based Smart Cruise Control may feel it is not sufficient due to road conditions such as uneven road surfaces, narrow lanes, etc.

LANE FOLLOWING ASSIST (LFA) (IF EQUIPPED)

Lane Following Assist is designed to help detect lane markings and/or vehicles on the road, and assists the driver's steering to help center the vehicle in the lane.

Detecting sensor



[1]: Front view camera

The front view camera is used as a detecting sensor to detect lane markings and front vehicles.

Refer to the picture above for the detailed location of the detecting sensor.



CAUTION

For more details on the precautions of the front view camera, refer to “Forward Collision-Avoidance Assist (FCA)” section in this chapter.

Lane Following Assist settings

Setting features

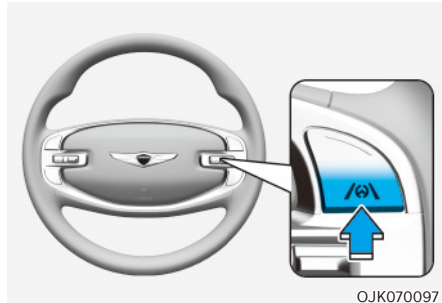

Turning Lane Following Assist On/Off

With the engine on, shortly press the Lane Driving Assist button located on the steering wheel to turn on Lane Following Assist. The grey or green  indicator light will illuminate on the cluster.

Press the button again to turn off the function.

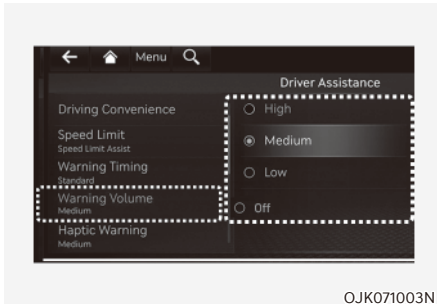

OJK071003N

Warning Volume

With the engine on, select 'Driver Assistance → Warning volume' or 'Sound → Driver Assist Warning → Warning Volume' from the Settings menu to change the Warning Volume to 'High', 'Medium', 'Low' or 'Off' for Hands-off warning.

However, even if 'Off' is selected, the Hands-off Warning Volume will not turn off but the volume will sound as 'Low'.

If you change the Warning Volume, the warning volume of other Driver Assistance systems may change.

Lane Following Assist operation

Warning and control



OJK070096

Lane Following Assist

If the vehicle ahead and/or both lane markings are detected and your vehicle speed is below 200 km/h (120 mph), the green  indicator light illuminates on the cluster, and Lane Following Assist helps center the vehicle in the lane by assisting the steering wheel.

CAUTION

When the steering wheel is not assisted, the white  indicator light blinks and changes to grey.

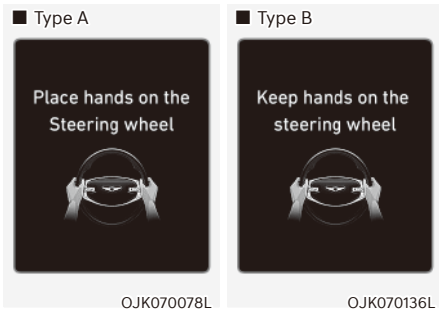

Hands-off warning

If the driver takes their hands off the steering wheel for several seconds, the 'Place hands on the steering wheel' (or 'Keep hands on the steering wheel') warning message will appear and an audible warning will sound in stages.

First stage : Warning message

Second stage : Warning message (red steering wheel) and audible warning

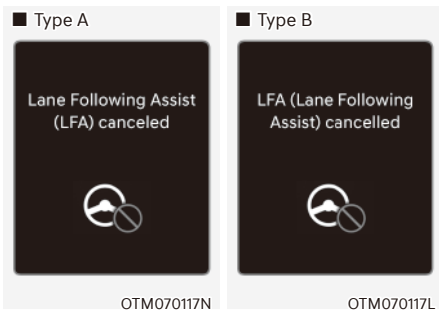

If the driver still does not have their hands on the steering wheel after the hands-off warning, the 'Lane Following Assist (LFA) canceled' (or 'LFA (Lane Following Assist) cancelled') warning message will appear and Lane Following Assist will be automatically canceled.

WARNING

- The steering wheel may not be assisted if the steering wheel is held very tight or the steering wheel is steered over a certain degree.
- Lane Following Assist does not operate at all times. It is the responsibility of the driver to safely steer the vehicle and to maintain the vehicle in its lane.
- The hands-off warning message may appear late depending on road conditions. Always have your hands on the steering wheel while driving.
- If the steering wheel is held very lightly the hands-off warning message may appear because Lane Following Assist may not recognize that the driver has their hands on the steering wheel.
- If you attach objects to the steering wheel, the hands-off warning may not work properly.

i Information

- For more details on setting the functions in the infotainment system, refer to “Vehicle Settings” section in chapter 4.
- When both lane markings are detected, the lane lines on the cluster will change from grey to white.



- If lane markings are not detected, steering wheel control by Lane Following Assist can be limited depending on whether a vehicle is in front or the driving conditions of the vehicle.
- Even though the steering is assisted by Lane Following Assist, the driver may control the steering wheel.
- The steering wheel may feel heavier or lighter when the steering wheel is assisted by Lane Following Assist than when it is not.

Lane Following Assist malfunction and limitations

Lane Following Assist malfunction

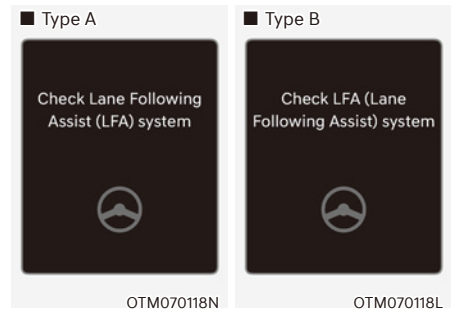

When Lane Following Assist is not working properly, the ‘Check Lane Following Assist (LFA) system’ (or ‘Check LFA (Lane Following Assist) system’) warning message will appear on the cluster for several seconds, and the master (⚠) warning light illuminates on the cluster. If this occurs, we recommend that the vehicle be inspected by an authorized retailer of Genesis Branded products.

Limitations of Lane Following Assist

For more details on Lane Following Assist limitations, refer to “Lane Keeping Assist (LKA)” section in this chapter.

i Information

For more details on Lane Following Assist precautions, refer to “Lane Keeping Assist (LKA)” section in this chapter.

HIGHWAY DRIVING ASSIST (HDA) (IF EQUIPPED)

Basic function

Highway Driving Assist is designed to help detect vehicles and lanes ahead, and help maintain distance from the vehicle ahead, maintain the set speed, and keep the vehicle in the lane while driving on the highway (or motorway).

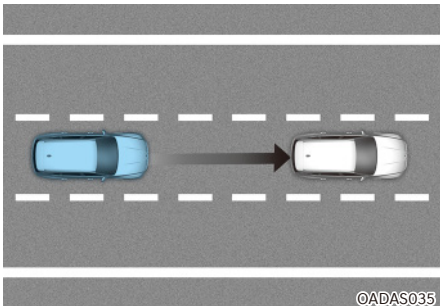

Highway Lane Change Assist (if equipped)

Highway Lane Change Assist function helps change lanes to the direction the driver slightly moves the turn signal switch if the function judges that lane change is possible.

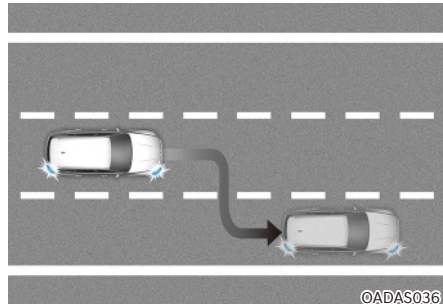

i Information

- Highway Driving Assist is available only on controlled access road of certain highways.
 - * Controlled access road indicates roads with limited entrances and exits that allow uninterrupted high speed traffic flow. Only passenger cars and motorcycles are allowed on controlled access roads.
- Additional highways may be expanded by future navigation updates.

i Information

Highway Driving Assist operates on main roads of highways (or motorways), and does not operate on interchanges or junctions.

Detecting sensor

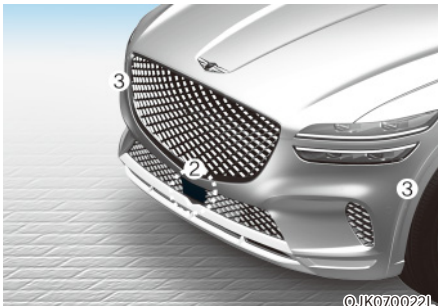

- [1] : Front view camera, [2]: Front radar,
[3] : Front corner radar (if equipped),
[4] : Rear corner radar (if equipped)

Refer to the picture above for the detailed location of the detecting sensors.

CAUTION

For more details on the precautions of the detecting sensors, refer to “Forward Collision-Avoidance Assist (FCA)” section in this chapter.

Highway Driving Assist settings

Setting features

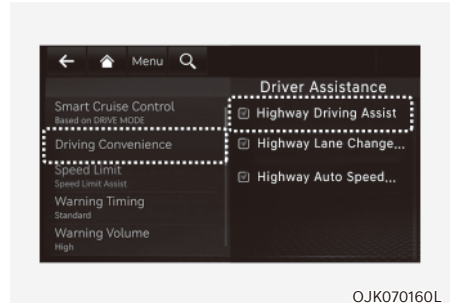

Basic function

With the engine on, select or deselect ‘Driver Assistance → Driving Convenience’ from the Settings menu to set whether or not to use each function.

- If ‘Highway Driving Assist’ is selected, it helps maintain distance from the vehicle ahead, maintain the set speed, and helps center the vehicle in the lane.

Highway Lane Change Assist (if equipped)

- If ‘Highway Lane Change Assist’ is selected, it helps the driver change lanes.

i Information

- When ‘Highway Driving Assist’ is deselected, the setting for ‘Highway Lane Change Assist’ cannot be changed.
- If there is a problem with the functions, the settings cannot be changed. We recommend that the vehicle be inspected by an authorized retailer of Genesis Branded products.
- If the engine is restarted, the functions will maintain the last setting.

! WARNING

For your safety, change the Settings after parking the vehicle at a safe location.

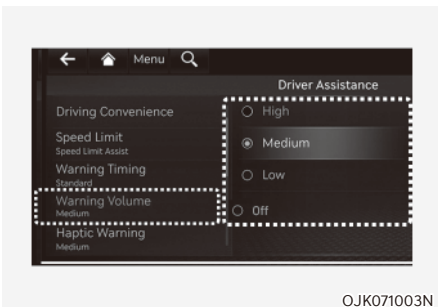

Warning Volume

With the engine on, select ‘Driver Assistance → Warning volume’ or ‘Sound → Driver Assist Warning → Warning Volume’ from the Settings menu to change the Warning Volume to ‘High’, ‘Medium’, ‘Low’ or ‘Off’ for Highway Driving Assist.

However, even if ‘Off’ is selected, the Hands-off Warning Volume will not turn off but the volume will sound as ‘Low’.

If you change the Warning Volume, the warning volume of other Driver Assistance systems may change.

Highway Driving Assist operation

Basic function

Display and control

You can see the status of the Highway Driving Assist operation in the Driving Assist view on the cluster. Refer to “View Modes” section in chapter 4.

Highway Driving Assist will be displayed as below depending on the status of the function.

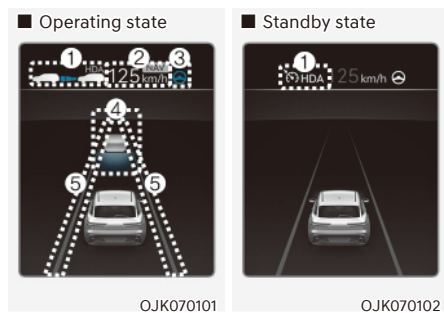

- (1) Highway Driving Assist indicator, whether there is a vehicle ahead and the selected distance level are displayed.

* Highway Driving Assist indicator

- Green HDA : Operating state
- Grey HDA : Standby state
- White HDA blink: Accelerator depressed state

- (2) Set speed is displayed.
- (3) Lane Following Assist indicator displayed.
- (4) Whether there is a vehicle ahead and the selected headway are displayed.
- (5) Whether the lane is detected or not is displayed.

i Information

For more details on the display refer to “Smart Cruise Control (SCC)” and “Lane Following Assist (LFA)” sections in this chapter.

Highway Driving Assist operating

Highway Driving Assist will operate when entering or driving on the main road of highways (or motorways), and satisfying all the following conditions:

- Lane Following Assist is operating
- Smart Cruise Control is operating

Information

- **While driving on the highway (or motorway), if Smart Cruise Control starts operating, Highway Driving Assist will operate.**
- **When entering the main roads of highways (or motorways) while Smart Cruise Control is operating, Driving Assist will not turn on if Lane Following Assist is turned off.**

- Restarting after stopping

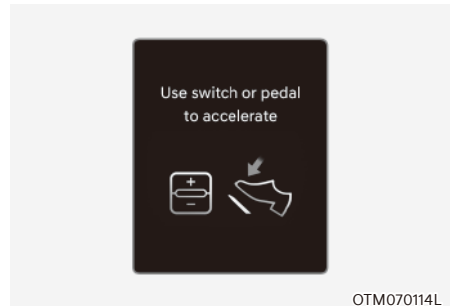

When Highway Driving Assist is operating, your vehicle will stop if the vehicle ahead of you stops. Also, if the vehicle ahead of you starts moving within 30 seconds after the stop, your vehicle will start as well. In addition, after the vehicle has stopped and 30 seconds have passed, the 'Use switch or pedal to accelerate' message will appear on the cluster. Depress the accelerator pedal or push the + switch, - switch or  switch to start driving.

- Hands-off warning

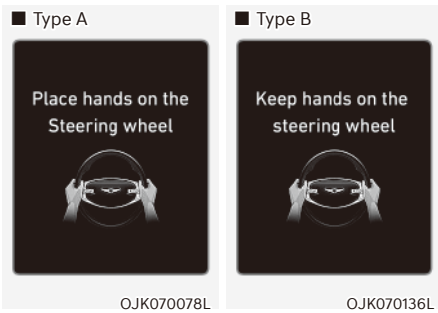

If the driver takes their hands off the steering wheel for several seconds, the 'Place hands on the steering wheel' (or 'Keep hands on the steering wheel') warning message will appear and an audible warning will sound in stages.

First stage : Warning message

Second stage : Warning message (red steering wheel) and audible warning

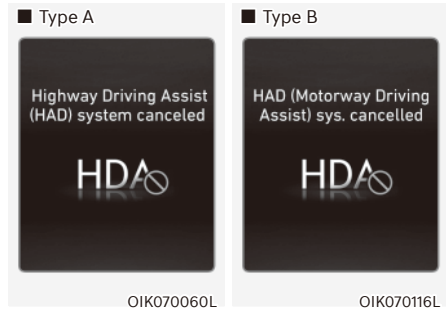

If the driver still does not have their hands on the steering wheel after the hands-off warning, the 'Highway Driving Assist (HDA) canceled' (or 'HDA (Highway Driving Assist) cancelled') warning message will appear and Highway Driving Assist and Lane Change Assist will be automatically canceled.

- Driving speed limit

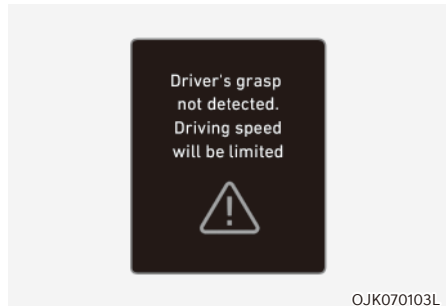

When Highway Driving Assist is canceled by the hands-off warning, The driving speed will be limited.

While Driving Speed Limit function is operating, the 'Driver's grasp not detected. Driving speed will be limited' warning message will appear on the cluster, and an audible warning will sound continuously.

- Driving to one side within lane (if equipped)

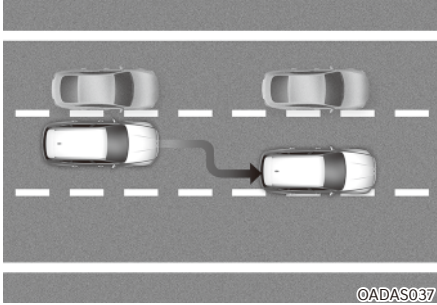

When vehicle speed is above 60 km/h (40 mph), if a vehicle around you is driving at a close distance, your vehicle will control steering in the opposite direction of the vehicle to assist in safe driving.

If there are vehicles in both sides of the lane that are driving close to you, the function will not veer to the opposite side of the lane.

Highway Driving Assist standby

When the Smart Cruise Control is temporarily canceled while Highway Driving Assist is operating, Highway Driving Assist will be in the standby state. At this time, Lane Following Assist will operate normally.

i Information

- **Driving Speed Limit** helps you drive below 60 km/h (40 mph). At this time, the vehicle decelerates due to the vehicle ahead. After the vehicle has decelerated, it cannot automatically accelerate.
- **Driving Speed Limit** will cancel in the following circumstances:
 - When the driver grabs the steering wheel again
 - When the driver turns on Lane Following Assist by pressing the Lane Driving Assist button
 - When Smart Cruise Control switch +, -, ||↻ or  button is pushed, or the accelerator pedal or the brake pedal is depressed

Highway Lane Change Assist (if equipped)

Display and control

You can see the status of the Highway Lane Change Assist function operation in the Driving Assist view on the cluster. Refer to “View Modes” section in chapter 4.

Highway Lane Change Assist function will be displayed as below depending on the status of the function.

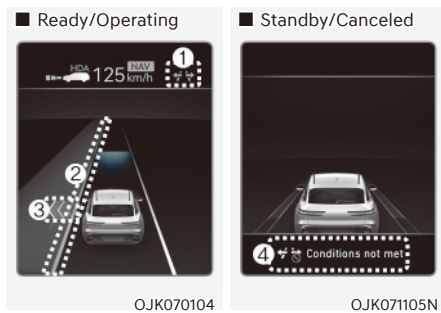

(1) Highway Lane Change Assist indicator

- Green on : Ready state
- Green blink : Operating state
- Grey on : Standby state
- White blink : Canceled state

(2) Green lane line

The green lane line is displayed when the function starts operating, and until the vehicle steps on the lane line.

(3) Green arrow and shade

The green arrow is displayed when a certain amount of time has passed after the function has started operating, and until the lane change has completed.

(4) Message

- Message is displayed when the function does not operate even though the turn signal lever is used.
- Message is displayed when the function is canceled while operating.

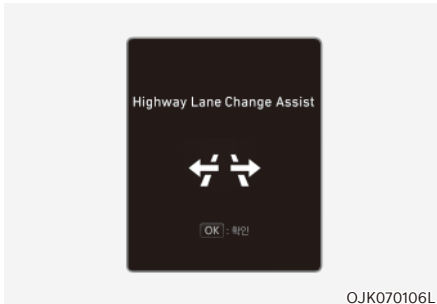

OJK070106L

To turn on Highway Lane Change Assist

Highway Lane Change Assist function will turn on when the following conditions are satisfied.

- The Driving Assist button or Lane Driving Assist button is used to turn on Highway Driving Assist.
- The OK button is pressed on the steering wheel while a message asking to use Highway Lane Change Assist is displayed on the cluster.

Highway Lane Change Assist ready to operate

While Highway Lane Change Assist function is on, the function will be ready to operate when all the following conditions are satisfied:

- Highway Driving Assist is operating
- Lane Following Assist is operating
- A vehicle in the rear area of your vehicle is detected more than once after the engine is turned on
- Your vehicle speed is above 80 km/h (50 mph)
- Hands-off warning is not displayed on the cluster
- Hazard warning flasher is off

i Information

- While Lane Change Assist function is turned on (indicator on), Lane Following Assist will not cancel even if the turn signal indicator or hazard warning flasher is operating.
- Lane Change Assist function turns off automatically when driven in the following road conditions:
 - One driving lane
 - A road with an intersection or crosswalk ahead
 - A road with no structure, such as a medium strip, guardrails, etc.
 - There is a pedestrian or cyclist on the road ahead
- When the function is in the ready state, and vehicle speed is below 75 km/h (45 mph), the function will change to the standby state.

! WARNING

When Highway Lane Change Assist function turns off while operating, steering assist will be temporarily canceled. Always be cautious while driving.

Highway Lane Change Assist operating

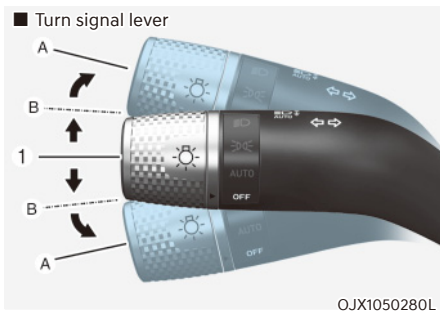

[1] : Center

Highway Lane Change Assist function will operate, when you push the turn signal lever up or down to the B position while the function is in the ready state (⚡ indicator is green), and all of the following conditions are satisfied:

- The driver has his/her hand on the steering wheel
- There is no collision risk in the direction of lane change
- There is a single dotted lane line in the direction of lane change
- There are no Forward Collision-Avoidance Assist and Blind Spot Collision-Avoidance Assist warnings
- The vehicle is driven in the middle of the lane (should not be driving close to one side of the lane)
- The road you are driving on, or the road you are about to change lane is a road that the function can operate

i Information

When the turn signal lever is placed at B position for a certain period of time, the green arrow will appear. At this time, even when the lever is released and returns to its original position (1), lane change will still be assisted.

While lane change is being made by the function, the turn signal indicator will blink even when the turn signal lever is not held, and the turn signal indicator will turn off when lane change is complete.

Highway Lane Change Assist standby

Highway Lane Change Assist function will be in the standby state when one of the ready state condition is not satisfied, or when entering or driving on one of the following roads:

- Road within a certain distance from the tollgate on the main road of the highway (or motorway)
- The road ahead ends without an interchange or junction
- Road with sharp curves
- Road with narrow lanes
- Road that is under construction

Highway Lane Change Assist cancel

The function will be canceled when:

- The turn signal lever is turned on in the opposite direction of lane change
- The steering wheel is steered sharply



WARNING

- While Highway Driving Assist is operating, the function will cancel if one of the following occurs:
 - Highway Driving Assist is turned off
 - Lane Following Assist or Smart Cruise Control is turned off or temporarily canceled
 - Hands-off warning message is displayed on the cluster
 - The turn signal lever is placed at A position
 - The hazard warning flasher is turned on
 - Forward Collision-Avoidance Assist or Blind-Spot Collision-Avoidance Assist warning message is displayed
 - Possible collision is detected in the next lane, even though there are no Forward Collision-Avoidance Assist and Blind Spot Collision-Avoidance Assist warning
 - Entering a road under construction
 - The target lane to make a lane change disappears
 - The target lane to make a lane change is not detected
 - There is a problem with turn signal lamps
- Highway Lane Change Assist function is off (The function turns off when the function is turned off from the settings menu, when the road changes to a one-way road, when there is a intersection or crosswalk ahead, when you enter a road with no structure, such as a medium strip, guardrail, etc., or when there is a pedestrian or cyclist on the driving lane.)
- Your vehicle speed is below 75 km/h (45 mph)
- While the function is operating, when the function is canceled, depending on the driving conditions, the vehicle may drive to the middle of the driving lane or steering assist may stop. Always pay attention to road and driving conditions while driving.
- The function may not operate normally on roads with pedestrians or cyclists, such as an intersection or crosswalk. Always pay attention to road and driving conditions while driving.

Highway Driving Assist malfunction and limitations

Highway Driving Assist malfunction



When Highway Driving Assist or Highway Lane Change function is not working properly, the 'Check Highway Driving Assist (HDA) system' or 'Check Lane Change Assist function' warning message will appear, and the  warning light will illuminate on the cluster. We recommend that the vehicle be inspected by an authorized retailer of Genesis Branded products

WARNING

- The driver is responsible for controlling the vehicle for safe driving.
- Always have your hands on the steering wheel while driving.
- Highway Driving Assist is a supplemental function that assists the driver in driving the vehicle and is not a complete autonomous driving system. Always check road conditions, and if necessary, take appropriate actions to drive safely.
- Always have your eyes on the road, and it is the responsibility of the driver to avoid violating traffic laws. The vehicle manufacturer is not responsible for any traffic violation or accidents caused by the driver.
- Highway Driving Assist may not be able to recognize all traffic situations. Highway Driving Assist may not detect possible collisions due to limitations of the function. Always be aware of the limitations of the function. Obstacles such as vehicles, motorcycles, bicycles, pedestrians, or unspecified objects or structures such as guardrails, tollgate, etc., that may collide with the vehicle may not be detected.
- Highway Driving Assist will turn off automatically under the following situations:
 - Driving on roads that Highway Driving Assist does not operate, such as a rest area, intersection, junction, etc.
 - The navigation does not operate properly such as when the navigation is being updated or restarted
- Highway Driving Assist may inadvertently operate or turn off depending on road conditions (navigation information) and surroundings.
- Lane Following Assist function may be temporarily disabled when the front view camera cannot detect lanes properly or the hands-off warning is on.
- You may not hear the warning sound of Highway Driving Assist if the surrounding is noisy.

- **If the vehicle is driven at high speed above a certain speed at a curve, your vehicle may drive to one side or may depart from the driving lane.**
- **When you are towing a trailer or another vehicle, turn off Highway Driving Assist for safety reasons.**
- **The hands-off warning message may appear early or late depending on how the steering wheel is held or road conditions. Always have your hands on the steering wheel while driving.**
- **For your safety, please read the owner's manual before using the Highway Driving Assist.**
- **Highway Driving Assist will not operate when the engine is started, or when the detecting sensors or navigation is being initialized.**
- GPS signals are blocked in areas such as a tunnel
- The driver goes off course or the route to the destination is changed or canceled by resetting the navigation
- The vehicle enters a service station or rest area
- Android Auto or Car Play is operating
- The navigation cannot detect the current vehicle position (ex: elevated roads including overpass adjacent to general roads or nearby roads exist in a parallel way)
- White single dotted lane line or road edge cannot be detected
- The road is temporarily controlled due to construction, etc.
- There is no structure, such as a medium strip, guardrails, etc., on the road
- There is a changeable lane in the direction of lane change

Limitations of Highway Driving Assist

Highway Driving Assist and Highway Lane Change function may not operate normally, or may not operate under the following circumstances:

- The map information and the actual road is different because the navigation is not updated
- The map information and the actual road is different because of real-time GPS data or map information error
- The infotainment system is overloaded by simultaneously performing functions such as route search, video playback, voice recognition, etc.

***i* Information**

For more details on the limitations of the front view camera, front radar, front corner radar and rear corner radar, refer to “Forward Collision-Avoidance Assist (FCA)” section in this chapter.

REAR VIEW MONITOR (RVM)

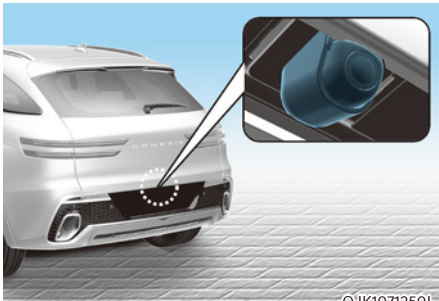

Rear View Monitor shows the area behind the vehicle to assist you when parking or backing up.

Detecting sensor

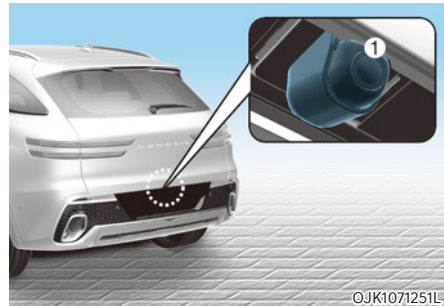

[1] : Rear view camera

Refer to the picture above for the detailed location of the detecting sensor.

Rear View Monitor settings

Camera settings

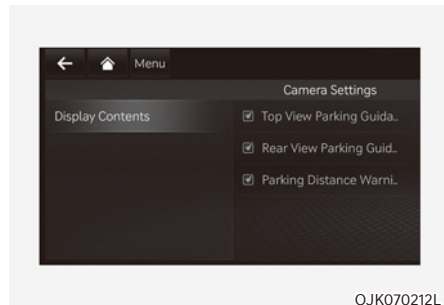

You can change Rear View Monitor 'Display Contents' or 'Display Settings' by touching the setup icon (⚙️) on the screen while Rear View Monitor is operating, or selecting 'Driver Assistance → Parking Safety → Camera Settings' from the Settings menu while the engine is on.

Rear View Monitor operation

Operating button

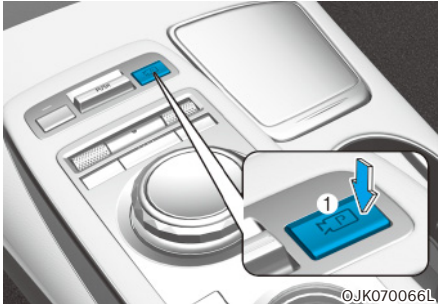

Parking/View button

Press the Parking/View button (1) to turn on Rear View Monitor.

Press the button again to turn off the function.

Rear view

Operating conditions

- Shift the gear to R (Reverse), the image will appear on the screen.
- Press the Parking/View button (1) while the gear is in P (Park), the image will appear on the screen.

Off conditions

- The rear view cannot be turned off when the gear is in R (Reverse).
- Press the Parking/View button (1) again while the gear is in P (Park) with the rear view on the screen, the rear view will turn off.
- Shift the gear from R (Reverse) to P (Park), the rear view will turn off.

Extended rear view function

The rear view will maintain showing on the screen to help you when parking.

Operating conditions

Shift the gear from R (Reverse) to N (Neutral) or D (Drive), the rear view will appear on the screen.

Off conditions

- When vehicle speed is above 10 km/h (6 mph), the rear view will turn off.
- Shift the gear to P (Park), the rear view will turn off.

Rear View while driving

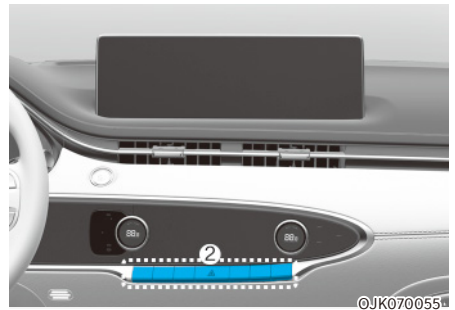

The driver is able to check the rear view on the screen while driving, it is to assist with safe driving.

Operating conditions

Press the Parking/View button (1) while the gear is in D (Drive) or N (Neutral), the driving rear view will appear on the screen.

Off conditions

- Press the Parking/View button (1) again, the driving rear view will turn off.
- Press one of the infotainment system button (2), the driving rear view will turn off.
- Shift the gear to P (Park), the driving rear view will turn off.

When operating

If the gear is shifted to R (Reverse), while Driving rear view is displayed on the screen, the screen will change to rear view with parking guidance.

Rear top view

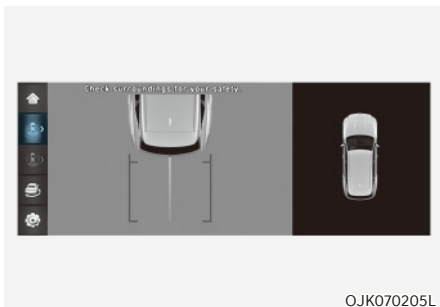

When you touch the  icon, the top view is displayed on the screen and shows the distance from the vehicle in the back of your vehicle while parking.

Rear View Monitor malfunction and limitations

Rear View Monitor malfunction

When Rear View Monitor is not working properly, or the screen flickers, or the camera image does not display normally, we recommend that the vehicle be inspected by an authorized retailer of Genesis Branded products.

Limitations of Rear View Monitor

When the vehicle is stopped for a long time in winter or when the vehicle is parked in an indoor parking lot, the exhaust fumes may temporarily blur the image.



WARNING

- **The rear view camera does not cover the complete area behind the vehicle. The driver should always check the rear area directly through the inside and outside rearview mirror before parking or backing up.**
- **The image shown on the screen may differ from the actual distance of the object. Make sure to directly check the vehicle's surroundings for safety.**
- **Always keep the rear view camera lens clean. If the lens is covered with foreign material, it may adversely affect camera performance and Rear View Monitor may not operate normally. However, do not use chemical solvents such as strong detergents containing high alkaline or volatile organic solvents (gasoline, acetone, etc.). This may damage the camera lens.**

SURROUND VIEW MONITOR (SVM) (IF EQUIPPED)

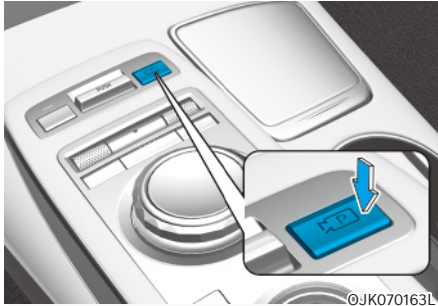

Surround View Monitor will assist in parking by allowing the driver to see around the vehicle.

Detecting sensor



- [1] : Surround-front view camera,
- [2],[3] : Surround-side view camera
(under the outside rearview mirror),
- [4] : Surround-rear view camera

Refer to the picture above for the detailed location of the detecting sensors.

Surround View Monitor settings

Camera settings

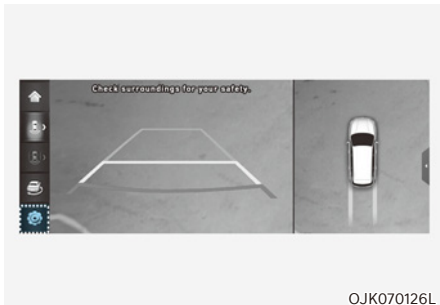

- You can change Surround View Monitor 'Display Contents' or 'Display Settings' by touching the setup icon (⚙️) on the screen while Surround View Monitor is operating, or selecting 'Driver Assistance → Parking Safety → Camera Settings' from the Settings menu while the engine is on.
- In the Display Contents, you can change settings for 'Top View Parking Guidance', 'Rear View Parking Guidance' and 'Parking Distance Warning'.

Top View Parking Guidance

■ Front top view



■ Rear top view



- When the 'Top View Parking Guidance' is selected, parking guidance is displayed on the right side of the Surround View Monitor screen.
- You may see the front top view or the rear top view when using Top View Parking Guidance.
- The 'Top View Parking Guidance' can be connected with the front top view parking guidance or the rear top view parking guidance.

Rear View Parking Guidance

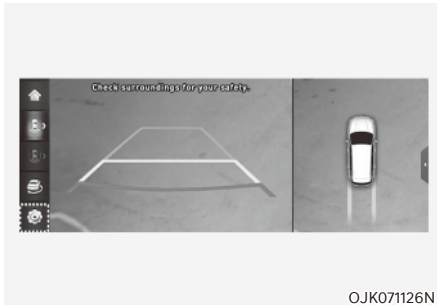

- When the 'Rear View Parking Guidance' is selected, parking guidance is displayed in the rear view.
- The horizontal guideline of the Rear View Parking Guidance shows the distance of 0.5 m (1.6 ft.), 1 m (3.3 ft.) and 2.3 m (7.6 ft.) from the vehicle.

Parking Distance Warning

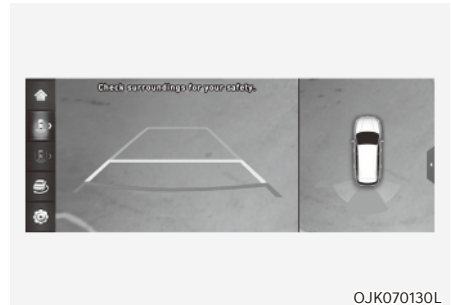

- When the 'Parking Distance Warning' is selected, parking distance warning is displayed on the right side of the Surround View Monitor screen.
- The image will be displayed only when Parking Distance Warning is warning the driver.

Surround View Monitor Auto On

With the engine on, select 'Driver Assistance → Parking Safety → Surround View Monitor Auto On' from the Settings menu to use the function.

Surround View Monitor operation

Operating button

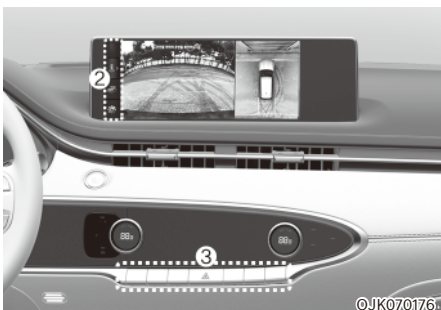
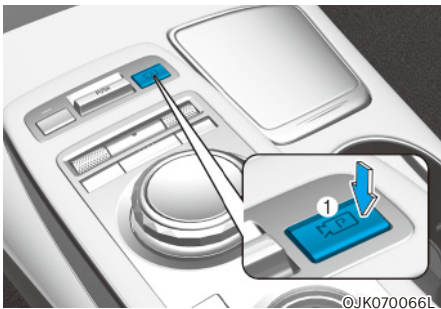

- Press the Parking/View button (1) to turn on Surround View Monitor. Press the button again to turn off the function.
- Other view modes can be selected by touching the view icons (2) on the Surround View Monitor screen.
- When one of the infotainment system button (3) is pressed without the gear in R (Reverse), Surround View Monitor will turn off.

Front view

The front image is displayed on the screen when the gear is in N (Neutral) or D (Drive) to assist in parking. The front view has a top view/front view/side view/3D view.

Operating conditions

- When the gear is shifted from R (Reverse) to N (Neutral) or D (Drive), the last set mode of front view function will be selected.
- Front view function will operate when the following conditions are satisfied:
 - While the infotainment system screen is being displayed, press the Parking/View button (1) briefly when the gear is in D (Drive) or N (Neutral) and vehicle speed is below 15 km/h (9 mph).
- Surround View Monitor Auto On function will operate when the following conditions are satisfied:
 - With 'Driver Assistance → Parking Safety → Surround View Monitor Auto On' selected from the Settings menu, the front parking assist view screen is displayed when Parking Distance Warning warns the driver while driving in D (Drive).

Off conditions

- Press the Parking/View button (1) again, the image will turn off.
- When vehicle speed is above 15 km/h (9 mph) with the gear in D (Drive), Surround View Monitor will turn off and the screen will change back to the previous infotainment system screen. Although you drive below 15 km/h (9 mph) again, Surround View Monitor will not turn on.
- Press one of the infotainment system button (3), the screen will change to the infotainment system screen.
- Shift the gear to P (Park), the image will turn off.

Rear view

The rear image is displayed on the screen when the gear is in P (Park) to assist in parking. The rear view has a top view/rear view/side view/3D view.

Operating conditions

- Shift the gear to R (Reverse), the image will appear on the screen.
- Press the Parking/View button (1) while the gear is in P (Park), the image will appear on the screen.

Off conditions

- The image cannot be turned off when the gear is in R (Reverse).
- Shift the gear from R (Reverse) to P (Park), the image will turn off.
- Press the Parking/View button (1) again while the gear is in P (Park) with the image on the screen.

Rear View while driving

The driver is able to check the rear view on the screen while driving, it is to assist with safe driving.

Operating conditions

- The engine is ON.
- Press the Parking/View button (1) when vehicle speed is above 15 km/h (9 mph), Rear View while driving will appear on the screen.
- The  icon is touched on the Surround View Monitor screen when vehicle speed is below 15 km/h (9 mph), Rear View while driving will appear on the screen.

Off conditions

- Press the Parking/View button (1) again, the screen will change back to the previous infotainment system screen.
- Select other view modes from the Surround View Monitor screen when vehicle speed is below 15 km/h (9 mph), Rear View while driving will turn off.
- Press one of the infotainment system button (3), the screen will change to the infotainment system screen.
- Shift the gear to P (Park), Rear View while driving will turn off.

Surround View Monitor malfunction and limitations

Surround View Monitor malfunction

When Surround View Monitor is not working properly, or the screen flickers, or the camera image does not display normally, we recommend that the vehicle be inspected by an authorized retailer of Genesis Branded products.

Limitations of Surround View Monitor

- When the vehicle is stopped for a long time in winter or when the vehicle is parked in an indoor parking lot, the exhaust fumes may temporarily blur the image.
- The screen may be displayed abnormally, and an icon will appear at the top left side of the screen under the following circumstances:
 - The tailgate is opened
 - The driver or front passenger door is opened
 - The outside rearview mirror is folded



WARNING

- **ALWAYS** look around your vehicle to make sure there are no objects or obstacles before moving the vehicle. What you see on the screen may differ from the actual vehicle's location.
- The image shown on the screen may differ from the actual distance of the object. Make sure to directly check the vehicle's surroundings for safety.
- Surround View Monitor is designed to be used on a flat surface. Therefore, if used on roads with different heights such as curbs and speed bumps, the image in the screen may not look correct.
- Always keep the camera lens clean. If the lens is covered with foreign material, it may adversely affect camera performance and Surround View Monitor may not operate normally. However, do not use chemical solvents such as strong detergents containing high alkaline or volatile organic solvents (gasoline, acetone, etc.). This may damage the camera lens.



Information

- When Rear View while Driving is on, it stays on while driving regardless of vehicle speed.
- When Rear View while Driving is on while backing up, the screen changes to the rear view.

REAR CROSS-TRAFFIC COLLISION-AVOIDANCE ASSIST (RCCA) (IF EQUIPPED)

Rear Cross-Traffic Collision-Avoidance Assist is designed to help detect vehicles approaching from the rear left and right side while your vehicle is reversing, and warn the driver that a collision is imminent with a warning message and an audible warning. Also, braking is assisted to help prevent collision.

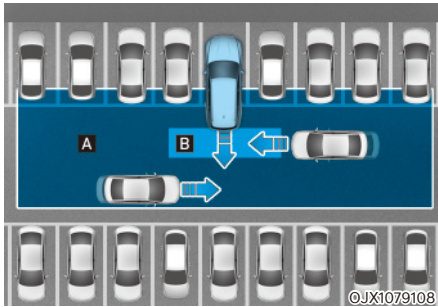

- [A] : Rear Cross-Traffic Collision Warning operating range,
 [B] : Rear Cross-Traffic Collision-Avoidance Assist operating range



CAUTION

Warning timing may vary depending on vehicle speed of the approaching vehicle.



Information

In the following text, Rear Cross-Traffic Collision Warning and Rear Cross-Traffic Collision-Avoidance Assist will be referred as Rear Cross-Traffic Safety system.

Detecting sensor



[1] : Rear corner radar

Refer to the picture above for the detailed location of the detecting sensors.



Information

For more details on the precautions of the rear corner radar, refer to “Blind-Spot Collision-Avoidance Assist (BCA)” section in this chapter.

Rear Cross-Traffic Safety system settings

Setting features

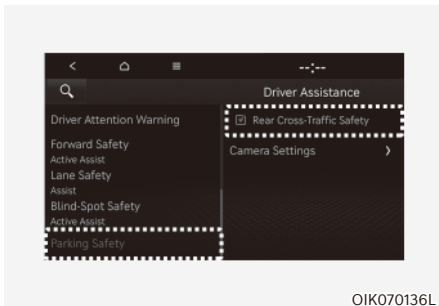

Rear Cross-Traffic Safety

With the engine on, select 'Driver Assistance → Parking Safety → Rear Cross-Traffic Safety' from the Settings menu to turn on Rear Cross-Traffic Safety system and deselect to turn off the system.



WARNING

When the engine is restarted, Rear Cross-Traffic Safety system will always turn on. However, if 'Off' is selected after the engine is restarted, the driver should always be aware of the surroundings and drive safely.



Information

Settings for Rear Cross-Traffic Safety system include Rear Cross-Traffic Collision Warning and Rear Cross-Traffic Collision-Avoidance Assist.

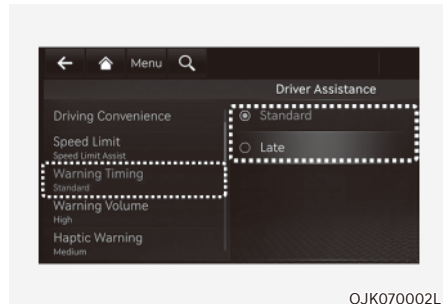

Warning Timing

With the engine on, select 'Driver Assistance → Warning Timing' from the Settings menu to change the initial warning activation time for Rear Cross-Traffic Safety system.

When the vehicle is first delivered, Warning Timing is set to 'Standard'. If you change the Warning Timing, the warning time of other Driver Assistance systems may change.

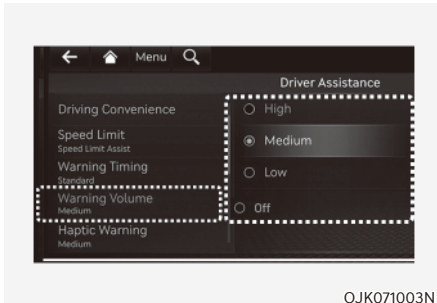

OJK071003N

Warning Volume

With the engine on, select 'Driver Assistance → Warning volume' or 'Sound → Driver Assist Warning → Warning Volume' from the Settings menu to change the Warning Volume to 'High', 'Medium', 'Low' or 'Off' for Rear Cross-Traffic Safety system.

However, when Warning Volume is turned off, the steering wheel vibration function will turn on if it was turned off.

If you change the Warning Volume, the warning volume of other Driver Assistance systems may change.



CAUTION

- The setting of the Warning Timing and Warning Volume applies to all functions of Rear Cross-Traffic Collision-Avoidance Assist.
- Even though 'Standard' is selected for Warning Timing, if the vehicles from the left and right side approaches at high speed, warning may seem late.
- Select 'Late' for Warning Timing when traffic is light and when driving speed is slow.



Information

If the engine is restarted, Warning Timing and Warning Volume will maintain the last setting.

Rear Cross-Traffic Safety system operation

Warning and control

Rear Cross-Traffic Safety system will warn and control the vehicle depending on collision risk level: 'Collision Warning', 'Emergency Braking' and 'Stopping vehicle and ending brake control'.

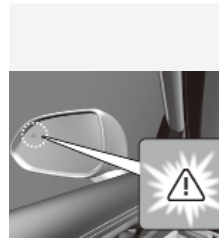

OPDEN060039



OJK070107



OJX1079166L

Collision Warning

- To warn the driver of an approaching vehicle from the rear left/right side of your vehicle, the warning light on the outside rearview mirror will blink and a warning will appear on the cluster. At the same time, an audible warning will sound and the steering wheel will vibrate. If the Rear View Monitor is operating, a warning will also appear on the infotainment system screen.

- Rear Cross-Traffic Safety system will operate when all the following conditions are satisfied:
 - The gear is shifted to R (Reverse)
 - Vehicle speed is below 8 km/h (5 mph)
 - The approaching vehicle is within approximately 25 m (82 ft.) from the left and right side of your vehicle
 - The speed of the vehicle approaching from the left and right is above 5 km/h (3 mph)

i Information

If the operating conditions are satisfied, there will be a warning whenever the vehicle approaches from the left or right side even though your vehicle speed is 0 km/h (0 mph).



Emergency Braking

- To warn the driver of an approaching vehicle from the rear left/right side of your vehicle, the warning light on the outside rearview mirror will blink and a warning message will appear on the cluster. At the same time, an audible warning will sound and the steering wheel will vibrate. A warning will also appear on the infotainment system screen.

- Rear Cross-Traffic Safety system will operate when all the following conditions are satisfied:
 - The gear is shifted to R (Reverse)
 - Vehicle speed is below 8 km/h (5 mph)
 - The approaching vehicle is within approximately 1.5 m (5 ft.) from the left and right side of your vehicle
 - The speed of the vehicle approaching from the left and right is above 5 km/h (3 mph)
- Emergency braking will be assisted to help prevent collision with approaching vehicles from the left and right.



WARNING

Brake control will end when:

- **The approaching vehicle is out of the detecting range**
- **The approaching vehicle passes behind your vehicle**
- **The approaching vehicle does not drive toward your vehicle**
- **The approaching vehicle speed slows down**
- **The driver depresses the brake pedal with sufficient power**

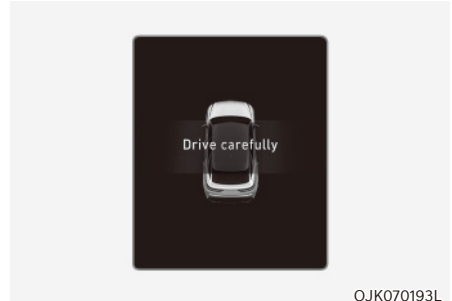

OJK070193L

Stopping vehicle and ending brake control

- When the vehicle is stopped due to emergency braking, the 'Drive carefully' warning message will appear on the cluster.
- For your safety, the driver should depress the brake pedal immediately and check the surroundings.
- Brake control will end after the vehicle is stopped by emergency braking for approximately 2 seconds.
- During emergency braking, braking control by Rear Cross-Traffic Safety system will automatically cancel when the driver excessively depresses the brake pedal.



WARNING

Take the following precautions when using Rear Cross-Traffic Safety system:

- For your safety, change the Settings after parking the vehicle at a safe location.
- If any other system's warning message is displayed or audible warning is generated, Rear Cross-Traffic Safety system's warning message may not be displayed and audible warning may not be generated.
- You may not hear the warning sound of Rear Cross-Traffic Safety system if the surrounding is noisy.
- Rear Cross-Traffic Safety system may not operate if the driver applies the brake pedal to avoid collision.
- During Rear Cross-Traffic Safety system operation, the vehicle may stop suddenly injuring passengers and shifting loose objects. Always have the seat belt on and keep loose objects secured.
- Even if there is a problem with Rear Cross-Traffic Safety system, the vehicle's basic braking performance will operate normally.
- When Rear Cross-Traffic Safety system is operating, braking control by the system will automatically cancel when the driver excessively depresses the accelerator pedal.
- Rear Cross-Traffic Safety system does not operate in all situations or cannot avoid all collisions.
- Rear Cross-Traffic Safety system may warn the driver late or may not warn the driver depending on the road and driving conditions.

- The driver should hold the responsibility to control the vehicle. Do not solely depend on Rear Cross-Traffic Safety system. Rather, maintain a safe braking distance, and if necessary, depress the brake pedal to reduce driving speed or to stop the vehicle.
- Never deliberately operate Rear Cross-Traffic Safety system on people, animal, objects, etc. It may cause serious injury or death.



CAUTION

The brake control may not operate properly depending on the status of ESC (Electronic Stability Control).

There will only be a warning when:

- The ESC (Electronic Stability Control) warning light is on
- ESC (Electronic Stability Control) is engaged in a different function



Information

If the system assists you with braking, the driver must immediately depress the brake pedal and check vehicle surroundings.

- Brake control will end when the driver depresses the brake pedal with sufficient power.
- After shifting the gear to R (Reverse), braking control will operate once for left and right vehicle approach.

Rear Cross-Traffic Safety system malfunction and limitations

Rear Cross-Traffic Safety system malfunction

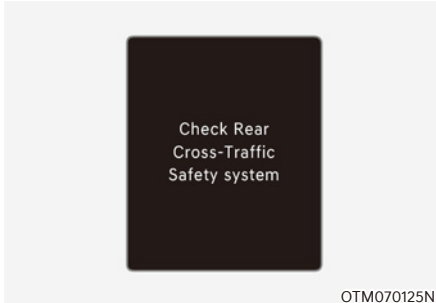

OTM070125N

When Rear Cross-Traffic Safety system is not working properly, the 'Check Rear Cross-Traffic Safety system' warning message will appear on the cluster for several seconds, and the master (⚠) warning light will illuminate on the cluster. If this occurs, we recommend that the vehicle be inspected by an authorized retailer of Genesis Branded products.

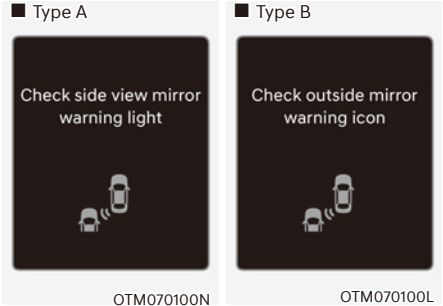

When the outside rearview mirror warning light is not working properly, the 'Check side view mirror warning light' (or 'Check outside mirror warning icon') warning message will appear on the cluster for several seconds, and the master (⚠) warning light will illuminate on the cluster. If this occurs, we recommend that the vehicle be inspected by an authorized retailer of Genesis Branded products.

Rear Cross-Traffic Safety system disabled

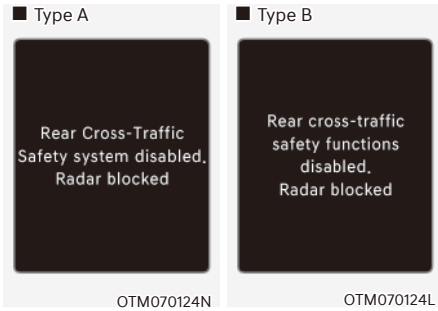

When the rear bumper around the rear-side radar or sensor is covered with foreign material, such as snow or rain, or installing a trailer or carrier, it can reduce the detecting performance and temporarily limit or disable Rear Cross-Traffic Safety system.

If this occurs, the 'Rear Cross-Traffic Safety system disabled. Radar blocked' (or 'Rear cross-traffic safety functions disabled. Radar blocked') warning message will appear on the cluster.

Rear Cross-Traffic Safety system will operate normally when such foreign material or trailer, etc., is removed.

If Rear Cross-Traffic Safety system does not operate normally after it is removed, we recommend that the vehicle be inspected by an authorized retailer of Genesis Branded products.

WARNING

- Even though the warning message does not appear on the cluster, Rear Cross-Traffic Safety system may not operate properly.
- Rear Cross-Traffic Safety system may not operate properly in an area (for example, open terrain), where any substance are not detected after turning ON the engine.

CAUTION

Turn off Rear Cross-Traffic Collision-Avoidance Assist to install or remove a trailer, carrier, or another attachment. Turn on Rear Cross-Traffic Collision-Avoidance Assist when finished.

Limitations of Rear Cross-Traffic Safety system

Rear Cross-Traffic Safety system may not operate normally, or the system may operate unexpectedly under the following circumstances:

- Departing from where trees or grass are overgrown
- Departing from where roads are wet
- Speed of the approaching vehicle is fast or slow

Braking control may not work, driver's attention is required in the following circumstances:

- The vehicle severely vibrates while driving over a bumpy road, uneven road or concrete patch
- Driving on a slippery surface due to snow, water puddle, ice, etc.
- The tire pressure is low or a tire is damaged
- The braking system has been modified
- Remote Smart Parking Assist is operating (if equipped)

Information

For more details on the limitations of the rear corner radar, refer to "Blind-Spot Collision-Avoidance Assist (BCA)" section in this chapter.



WARNING

- Driving near a vehicle or structure

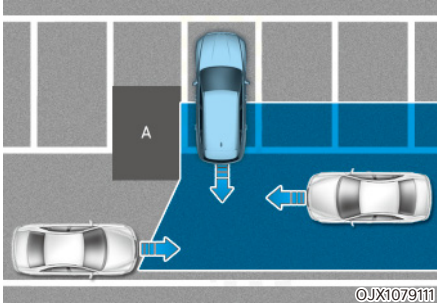

[A] : Structure

Rear Cross-Traffic Safety system may be limited when driving near a vehicle or structure, and may not detect the vehicle approaching from the left or right. If this occurs, the system may not warn the driver or control the brakes when necessary. Always check your surroundings while backing up.

- When the vehicle is in a complex parking environment

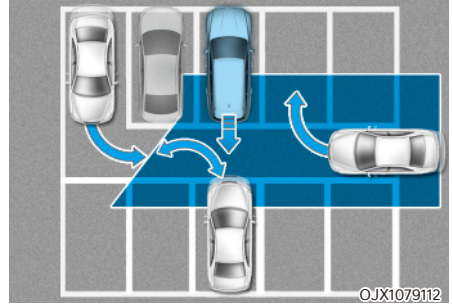

Rear Cross-Traffic Safety system may detect vehicles which are parking or pulling out near your vehicle (for example, a vehicle leaving beside your vehicle, a vehicle parking or pulling out in the rear area, a vehicle approaching your vehicle making a turn, etc.). If this occurs, the system may unnecessarily warn the driver and control the brake.

Always check your surroundings while backing up.

- When the vehicle is parked diagonally

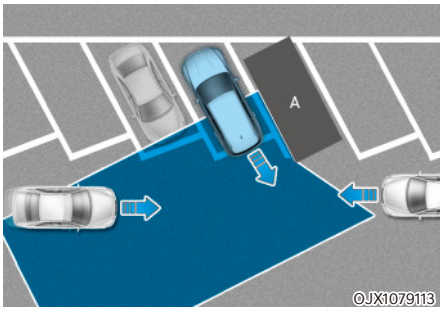

[A] : Vehicle

Rear Cross-Traffic Safety system may be limited when backing up diagonally, and may not detect the vehicle approaching from the left or right. If this occurs, the system may not warn the driver or control the brakes when necessary.

Always check your surroundings while backing up.

- When the vehicle is on or near a slope

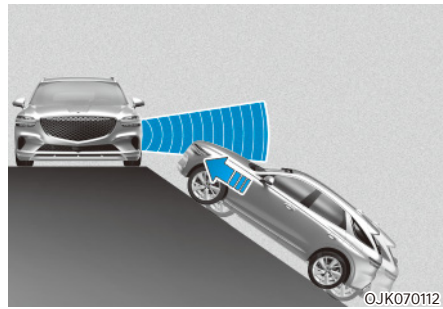

Rear Cross-Traffic Safety system may be limited when the vehicle is on an uphill or downhill slope, or near it, and may not detect the vehicle approaching from the left or right. If this occurs, the system may not warn the driver or control the brakes when necessary.

Always check your surroundings while backing up.

- Pulling into the parking space where there is a structure

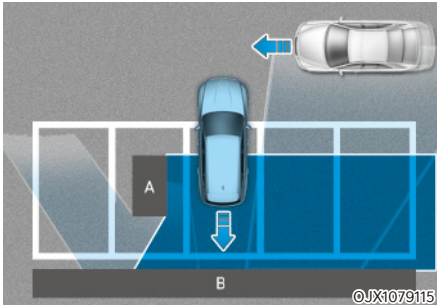

[A] : Structure, [B] : Wall

Rear Cross-Traffic Safety system may detect vehicles passing by in front of you when parking in reverse into a parking space with a wall or structure in the rear or side area. If this occurs, the system may unnecessarily warn the driver and control the brake.

Always check your surroundings while backing up.

- When the vehicle is parked rearward

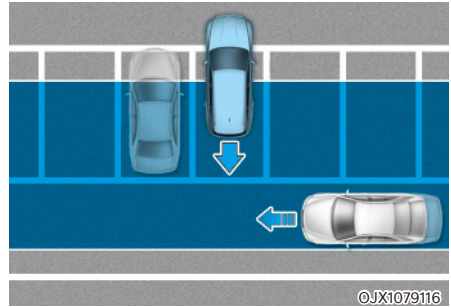

Rear Cross-Traffic Safety system may detect vehicles passing by behind you when parking in reverse into a parking space. If this occurs, the system may unnecessarily warn the driver and control the brake.

Always check your surroundings while backing up.

WARNING

- When you are towing a trailer, turn off Rear Cross-Traffic Collision-Avoidance Assist for safety reasons.
- Rear Cross-Traffic Safety system may not operate normally if interfered by strong electromagnetic waves.
- Rear Cross-Traffic Safety system may not operate for 15 seconds after the vehicle is started, or the rear corner radars are initialized.

REVERSE PARKING DISTANCE WARNING (PDW)

Reverse Parking Distance Warning will help warn the driver if an obstacle is detected within a certain distance when the vehicle is moving in reverse at low speeds.

Detecting sensor

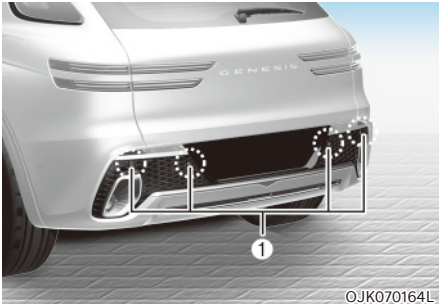

[1] : Rear ultrasonic sensors

Refer to the picture above for the detailed location of the detecting sensors.

Reverse Parking Distance Warning settings

Warning Volume

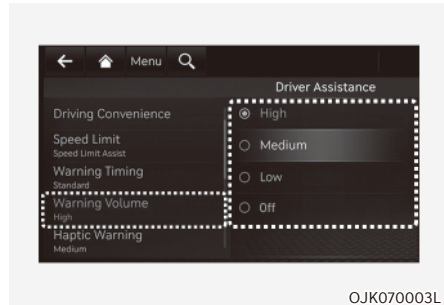

Select 'Driver Assistance → Warning Volume' from the infotainment system Settings menu to change the Warning Volume to 'High', 'Medium', 'Low' or 'Off' for Reverse Parking Distance Warning.

However, even if 'Off' is selected, Warning Volume of Reverse Parking Distance Warning will not turn off but the volume will sound as 'Low'.

If you change the Warning Volume, the Warning Volume of other Driver Assistance systems may change.

Reverse Parking Distance Warning operation Operating button

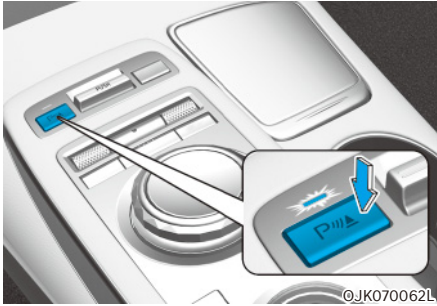



Parking Safety button (if equipped)

- Press the Parking Safety (P) button to turn on Reverse Parking Distance Warning. Press the button again to turn off the function.
- When Reverse Parking Distance Warning is off (button indicator light on), if you shift the gear to R (Reverse), Reverse Parking Distance Warning will automatically turn on.

Reverse Parking Distance Warning

- Reverse Parking Distance Warning will operate when the gear is in R (Reverse).
- Reverse Parking Distance Warning detects a person, animal or object in the rear when the vehicle's rearward speed is below 10 km/h (6 mph).

Distance from object	Warning indicator	Warning sound
	Driving rearward	
60–120 cm (24–48 in.)		Buzzer beeps intermittently
30–60 cm (12–24 in.)		Beeps more frequently
within 30 cm (12 in.)		Beeps continuously

- The corresponding indicator will illuminate whenever each ultrasonic sensor detects a person, animal or object in its sensing range. Also an audible warning will sound.
- When more than two objects are detected at the same time, the closest one will be warned with an audible warning.
- The shape of the indicator in the illustration may differ from the actual vehicle.

Reverse Parking Distance Warning malfunction and precautions

Reverse Parking Distance Warning malfunction

After starting the engine, a beep will sound when the gear is shifted to R (Reverse) to indicate Reverse Parking Distance Warning is operating normally.

However, if one or more of the following occurs, first check whether the ultrasonic sensor is damaged or blocked with foreign material. If it still does not work properly, we recommend that the vehicle be inspected by an authorized retailer of Genesis Branded products.

- The audible warning does not sound.
- The buzzer sounds intermittently.
- The 'Ultrasonic sensor error or blockage' warning message appears on the cluster.

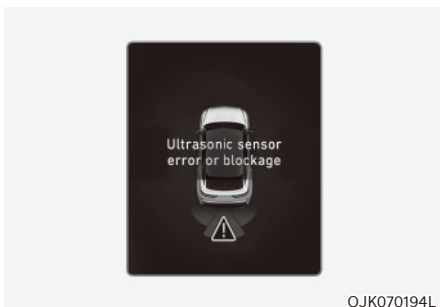

WARNING

- Reverse Parking Distance Warning is a supplemental function. The operation of Reverse Parking Distance Warning can be affected by several factors (including environmental conditions). It is the responsibility of the driver to always check the rear view before and while parking.
- Your new vehicle warranty does not cover any accidents or damage to the vehicle due to the malfunction of Reverse Parking Distance Warning.
- Pay close attention when driving near objects, pedestrians, and especially children. Some objects may not be detected by the ultrasonic sensors, due to the objects distance, size or material, all of which can limit the effectiveness of the sensor.

Limitations of Reverse Parking Distance Warning

- Reverse Parking Distance Warning may not operate normally when:
 - Moisture is frozen to the sensor
 - Sensor is covered with foreign material, such as snow or water (Reverse Parking Distance Warning will operate normally when such foreign material are removed.)
 - The weather is extremely hot or cold The sensor or sensor assembly is disassembled
 - The surface of the sensor is pressed hard or hit with a hard object
 - The surface of the sensor is scratched with a sharp object
 - The sensors or its surrounding area is directly sprayed with high pressure washer
- Reverse Parking Distance Warning may malfunction when:
 - Heavy rain or water spray is present
 - Water flows on the surface of the sensor
 - Affected by another vehicle's sensors
 - The sensor is covered with snow
 - Driving on uneven road, gravel roads or bushes
 - Objects that generates ultrasonic waves are near the sensor
 - Installing the license plate differently from the original location
 - The vehicle bumper height or ultrasonic sensor installation has been modified
 - Attaching equipments or accessories around the ultrasonic sensors
- The following objects may not be detected:
 - Sharp or slim objects, such as ropes, chains or small poles.
 - Objects, which tend to absorb sensor frequency, such as clothes, spongy material or snow.
 - Objects smaller than 100 cm (40 in.) in length and narrower than 14 cm (6 in.) in diameter.
 - Pedestrians, animals or objects that are very close to the ultrasonic sensors
- Parking Distance Warning Indicators may be displayed differently from the actual detected location when the obstacle is located between the sensors.
- Parking Distance Warning indicator may not occur sequentially depending on vehicle speed or obstacle shape.
- If Reverse Parking Distance Warning needs repair, we recommend that the vehicle be inspected by an authorized retailer of Genesis Brand products.

FORWARD/REVERSE PARKING DISTANCE WARNING (PDW) (IF EQUIPPED)

Forward/Reverse Parking Distance Warning will help warn the driver if an obstacle is detected within a certain distance when the vehicle is moving forward or in reverse at low speeds.

Detecting sensor

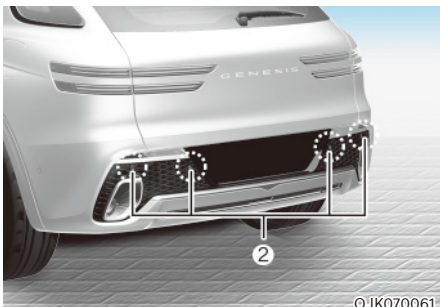
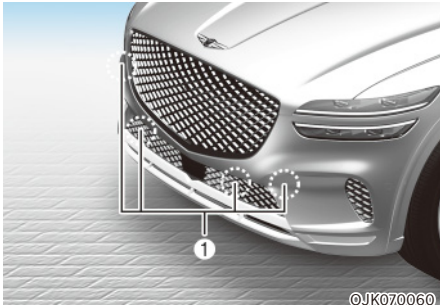

[1] : Front ultrasonic sensors,
[2] : Rear ultrasonic sensors

Refer to the picture above for the detailed location of the detecting sensors.

Forward/Reverse Parking Distance Warning settings

Warning Volume

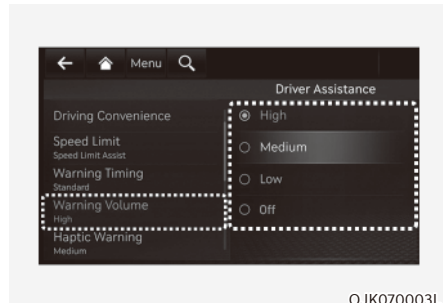

Select 'Driver Assistance → Warning Volume' from the cluster or infotainment system Settings menu to change the Warning Volume to 'High', 'Medium', 'Low' or 'Off' for Forward/Reverse Parking Distance Warning.

However, even if 'Off' is selected, the Warning Volume of Forward/Reverse Parking Distance Warning will not turn off but the volume will sound as 'Low'.

If you change the Warning Volume, the Warning Volume of other Driver Assistance systems may change.

Parking Distance Warning Auto On

To use Parking Distance Warning Auto On function, select 'Driver Assistance → Parking Safety → Parking Distance Warning Auto On' from the cluster or infotainment system Settings menu.

Forward/Reverse Parking Distance Warning Operating button

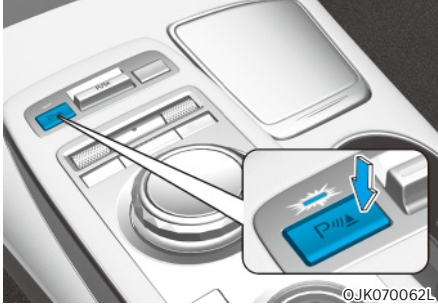

Parking Safety button



- Press the Parking Safety (P) button to turn on Forward/Reverse Parking Distance Warning. Press the button again to turn off the function.
- When Forward/Reverse Parking Distance Warning is off (button indicator light off), if you shift the gear to R (Reverse), Forward/Reverse Parking Distance Warning will automatically turn on.

- When Forward/Reverse Parking Distance Warning turns on, the button indicator light will turn on. If vehicle speed is above 20 km/h (12 mph), Forward/Reverse Parking Distance Warning will turn off (button indicator light off).
- * If equipped with Reverse Parking Collision-Avoidance Assist or Remote Smart Parking Assist, Forward/Reverse Parking Distance Warning will turn off (button indicator light off) when vehicle speed is above 30 km/h (18 mph).

Forward Parking Distance Warning

- Forward Parking Distance Warning will operate when one of the condition is satisfied.
 - The gear is shifted from R (Reverse) to D (Drive) with Reverse Parking Distance Warning on
 - The gear is in D (Drive) and the Parking Safety button indicator light is on
 - 'Parking Distance Warning Auto On' is selected from the Settings menu and the gear is in D (Drive)
- Forward Parking Distance Warning detects a person, animal or object in front when the vehicle's forward speed is below 10 km/h (6 mph).
- Forward Parking Distance Warning does not operate when the vehicle's forward speed is above 10 km/h (6 mph) even when the Parking Safety button indicator is on. Forward Parking Distance Warning will operate again when the vehicle's forward speed decreases below 10 km/h (6 mph) while the Parking Safety button indicator is on.
- When 'Parking Distance Warning Auto On' is selected, the Parking Safety button indicator light stays on.



- When 'Parking Distance Warning Auto On' is deselected, and the vehicle's forward speed is above 20 km/h (12 mph), the Parking Safety button indicator will turn off. Although you drive below 10 km/h (6 mph), Forward Parking Distance Warning will not turn on.
 - * If equipped with Reverse Parking Collision-Avoidance Assist or Remote Smart Parking Assist, Forward/Reverse Parking Distance Warning will turn off when vehicle speed is above 30 km/h (18 mph).

Distance from object	Warning indicator	Warning sound
	Driving forward	
60~100 cm (24~40 in.)		Buzzer beeps intermittently
30~60 cm (12~24 in.)		Beeps more frequently
within 30 cm (12 in.)		Beeps continuously

- The corresponding indicator will illuminate whenever each ultrasonic sensor detects a person, animal or object in its sensing range. Also an audible warning will sound.
- When more than two objects are detected at the same time, the closest one will be warned with an audible warning.
- The shape of the indicator in the illustration may differ from the actual vehicle.

Reverse Parking Distance Warning

- Reverse Parking Distance Warning will operate when the gear is in R (Reverse).
- Reverse Parking Distance Warning detects a person, animal or object in the rear when the vehicle's rearward speed is below 10 km/h (6 mph).
- When the vehicle's rearward speed is below 10 km/h (6 mph), both the front and rear ultrasonic sensors will detect objects. However, the front ultrasonic sensors can detect a person, animal or object when it is within 60 cm (24 in.) from the sensors.

Distance from object	Warning indicator	Warning sound
	Driving rearward	
60~120 cm (24~48 in.)		Buzzer beeps intermittently
30~60 cm (12~24 in.)		Beeps more frequently
within 30 cm (12 in.)		Beeps continuously

- The corresponding indicator will illuminate whenever each ultrasonic sensor detects a person, animal or object in its sensing range. Also an audible warning will sound.
- When more than two objects are detected at the same time, the closest one will be warned with an audible warning.
- The shape of the indicator in the illustration may differ from the actual vehicle.

Forward/Reverse Parking Distance Warning malfunction and precautions

Forward/Reverse Parking Distance Warning malfunction

After starting the engine, a beep will sound when the gear is shifted to R (Reverse) to indicate Forward/Reverse Parking Distance Warning is operating normally.

However, if one or more of the following occurs, first check whether the ultrasonic sensor is damaged or blocked with foreign material. If it still does not work properly, we recommend that the vehicle be inspected by an authorized retailer of Genesis Branded products.

- The audible warning does not sound.
- The buzzer sounds intermittently.
- The 'Ultrasonic sensor error or blockage' warning message appears on the cluster.

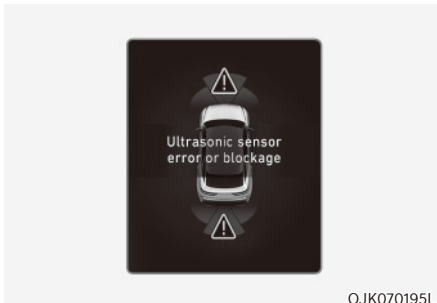

OJK070195L



WARNING

- Forward/Reverse Parking Distance Warning is a supplemental function. The operation of Forward/Reverse Parking Distance Warning can be affected by several factors (including environmental conditions). It is the responsibility of the driver to always check the front and rear views before and while parking.
- Your new vehicle warranty does not cover any accidents or damage to the vehicle due to the malfunction of Forward/Reverse Parking Distance Warning.
- Pay close attention when driving near objects, pedestrians, and especially children. Some objects may not be detected by the ultrasonic sensors, due to the objects distance, size or material, all of which can limit the effectiveness of the sensor.

Limitations of Forward/Reverse Parking Distance Warning

- Forward/Reverse Parking Distance Warning may not operate normally when:
 - Moisture is frozen to the sensor
 - Sensor is covered with foreign material, such as snow or water (Forward/Reverse Parking Distance Warning will operate normally when such foreign material are removed.)
 - The weather is extremely hot or cold
 - The sensor or sensor assembly is disassembled
 - The surface of the sensor is pressed hard or hit with a hard object
 - The surface of the sensor is scratched with a sharp object
 - The sensors or its surrounding area is directly sprayed with high pressure washer
- Forward/Reverse Parking Distance Warning may malfunction when:
 - Heavy rain or water spray is present
 - Water flows on the surface of the sensor
 - Affected by another vehicle's sensors
 - The sensor is covered with snow or ice
 - Driving on uneven road, gravel roads or bushes
 - Objects that generates ultrasonic waves are near the sensor
 - Installing the license plate differently from the original location
 - The vehicle bumper height or ultrasonic sensor installation has been modified
 - Attaching equipment or accessories around the ultrasonic sensors
- The following objects may not be detected:
 - Sharp or slim objects, such as ropes, chains or small poles.
 - Objects, which tend to absorb sensor frequency, such as clothes, spongy material or snow.
 - Objects smaller than 100 cm (40 in.) in length and narrower than 14 cm (6 in.) in diameter.
 - Pedestrians, animals or objects that are very close to the ultrasonic sensors
- Parking Distance Warning Indicators may be displayed differently from the actual detected location when the obstacle is located between the sensors.
- Parking Distance Warning indicator may not occur sequentially depending on vehicle speed or obstacle shape.
- If Forward/Reverse Parking Distance Warning needs repair, we recommend that the vehicle be inspected by an authorized retailer of Genesis Branded products.

REVERSE PARKING COLLISION-AVOIDANCE ASSIST (PCA) (IF EQUIPPED)

Reverse Parking Collision-Avoidance Assist will warn the driver or will assist with braking to help reduce the possibility of collision with a pedestrian or an object when backing up.

Detecting sensor

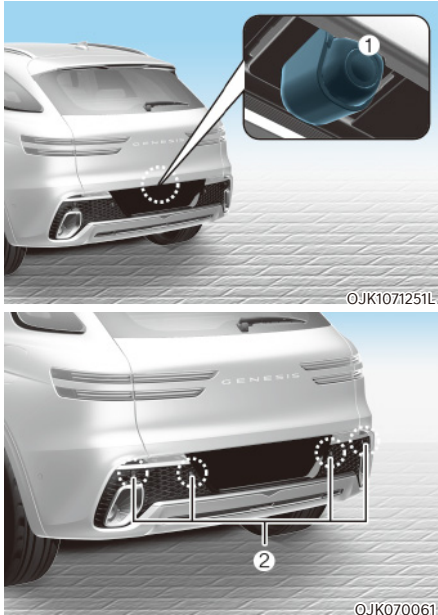

[1] : Rear view camera,

[2] : Rear ultrasonic sensors

Refer to the picture above for the detailed location of the detecting sensors.

Reverse Parking Collision-Avoidance Assist settings

Setting features

Parking Safety

- With the engine on, select or deselect 'Driver Assistance → Parking Safety' from the Settings menu to set whether or not to use each function.
 - If 'Rear Active Assist' (or 'Active rear assist') is selected, Reverse Parking Collision-Avoidance Assist will warn the driver and assist with braking when a collision with a pedestrian or an object is imminent.
 - If 'Rear Warning Only' (or 'Rear warning only') is selected, Reverse Parking Collision-Avoidance Assist will warn the driver when a collision with a pedestrian or an object is imminent. Braking will not be assisted.
 - If 'Off' is selected, Reverse Parking Collision-Avoidance Assist will turn off.
- If Parking Safety (P ) button is pressed more than 2 seconds, 'Rear Active Assist' or 'Rear Warning Only' can be turned on or off.

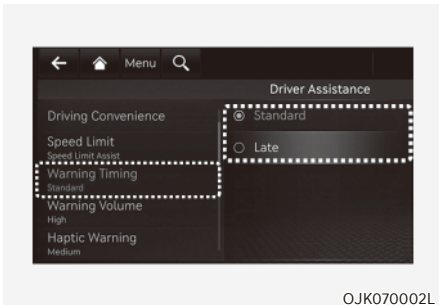

Warning Timing

With the engine on, select 'Driver Assistance → Warning Timing' from the Settings menu to change the initial warning activation time for Reverse Parking Collision-Avoidance Assist. When the vehicle is first delivered, Warning Timing is set to 'Standard'.

If you change the Warning Timing, the warning time of other Driver Assistance systems may change.

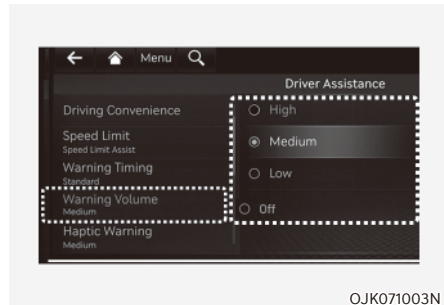

Warning Volume

With the engine on, select 'Driver Assistance → Warning Volume' from the Settings menu to change the Warning Volume to 'High', 'Medium', 'Low' or 'Off' for Reverse Parking Collision-Avoidance Assist.

However, when Warning Volume is turned off, the steering wheel vibration function will turn on if it was turned off.

If you change the Warning Volume, the warning volume of other Driver Assistance systems may change.

Reverse Parking Collision-Avoidance Assist operation

Operating conditions

If 'Rear Active Assist' or 'Rear Warning Only' is set from the Settings menu, Reverse Parking Collision-Avoidance Assist will be in the ready status when the following conditions are satisfied:

- The tailgate is closed
- The gear is shifted to R (Reverse)
- Vehicle speed is below 10 km/h (6 mph)
- Reverse Parking Collision-Avoidance Assist components such as the rear view camera and the rear ultrasonic sensors are in normal conditions

When Reverse Parking Collision-Avoidance Assist activates, a line appears behind the vehicle image in the instrument cluster.

Reverse Parking Collision-Avoidance Assist operates only once after the gear is shifted to R (Reverse). To reactivate Reverse Parking Collision-Avoidance Assist, shift the gear from another gear to R (Reverse).

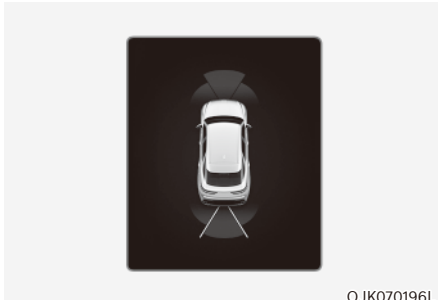

OJK070196L

Rear Active Assist

- If Reverse Parking Collision-Avoidance Assist detects a risk of collision with a pedestrian or an object, Reverse Parking Collision-Avoidance Assist will warn the driver with an audible warning and warning message on the cluster. When Rear View Monitor is operating, a warning will appear on the infotainment system screen.
- If Reverse Parking Collision-Avoidance Assist detects an imminent collision with a pedestrian or an object behind the vehicle, Reverse Parking Collision-Avoidance Assist will assist you with braking. The driver needs to pay attention as the brake assist will end within 2 seconds. The driver must immediately depress the brake pedal and check vehicle surroundings.
- Brake control will end when:
 - The gear is shifted to P (Park) or D (Drive).
 - The driver depresses the brake pedal with sufficient power
 - Braking assist has last for approximately 2 seconds
- The warning will turn off when:
 - The gear is shifted to P (Park), N (Neutral), or D (Drive)
- The brake control may not operate properly depending on the status of ESC (Electronic Stability Control). There will only be a warning when:
 - The ESC (Electronic Stability Control) warning light is on
 - ESC (Electronic Stability Control) is engaged in a different function

Rear Warning Only

- If Reverse Parking Collision-Avoidance Assist detects a risk of collision with a pedestrian or an object, Reverse Parking Collision-Avoidance Assist will warn the driver with an audible warning and warning message on the cluster. When Rear View Monitor is operating, a warning will appear on the infotainment system screen.
- If 'Rear Warning Only' is selected, braking will not be assisted.
- The warning will turn off when the gear is shifted to P (Park), N (Neutral) or D (Drive).

Reverse Parking Collision-Avoidance Assist malfunction and limitations

Reverse Parking Collision-Avoidance Assist malfunction

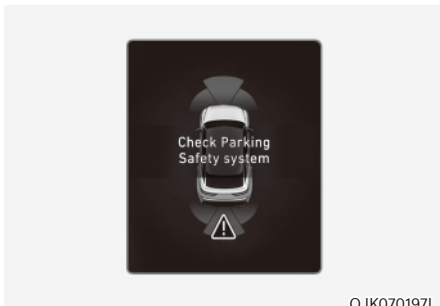

When Reverse Parking Collision-Avoidance Assist or other related functions are not working properly, the 'Check Parking Safety system' warning message will appear on the cluster, and Reverse Parking Collision-Avoidance Assist will turn off automatically. We recommend that the vehicle be inspected by an authorized retailer of Genesis Branded products.

Reverse Parking Collision-Avoidance Assist disabled

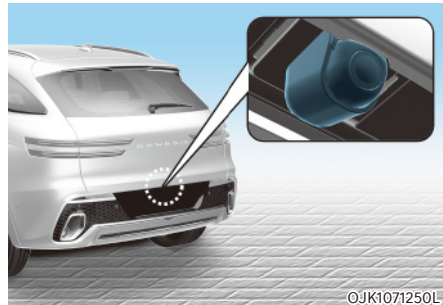

The rear view camera is used as a detecting sensor to detect pedestrians. If the camera lens is covered with foreign material, such as snow or rain, it may adversely affect camera performance and Reverse Parking Collision-Avoidance Assist may not operate normally. Always keep the camera lens clean.



The rear ultrasonic sensors are located inside the rear bumper to detect objects in the rear area. If the sensors are covered with foreign material, such as snow or rain, it may adversely affect sensor performance and Reverse Parking Collision-Avoidance Assist may not operate normally. Always keep the rear bumper clean.

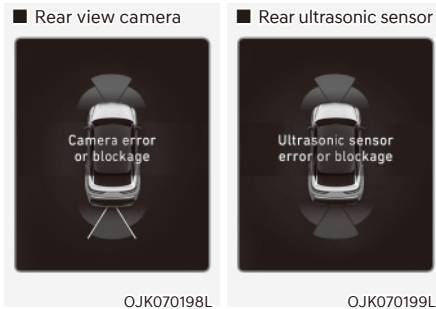

The 'Camera error or blockage' or 'Ultrasonic sensor error or blockage' warning message will appear on the cluster if the following situations occur:

- The rear view camera or rear ultrasonic sensor(s) is covered with foreign material, such as snow or rain, etc.
- There is inclement weather, such as heavy snow, heavy rain, etc.

If this occurs, Reverse Parking Collision-Avoidance Assist may turn off or may not operate properly. Check whether the rear view camera and rear ultrasonic sensors are clean.

Limitations of Reverse Parking Collision-Avoidance Assist

Reverse Parking Collision-Avoidance Assist may not assist braking or warn the driver even if there are pedestrians or objects under the following circumstances:

- Any non-factory equipment or accessory is installed
- Your vehicle is unstable due to an accident or other causes
- Bumper height or rear ultrasonic sensor installation has been modified
- Rear view camera or rear ultrasonic sensor(s) is damaged
- Rear view camera or the rear ultrasonic sensor(s) is stained with foreign material, such as snow, dirt, etc.
- Rear view camera is obscured by a light source or by inclement weather, such as heavy rain, fog, snow, etc.
- The surrounding is very bright or very dark
- Outside temperature is very high or very low
- The wind is either strong (above 20 km/h (12 mph)) or blowing perpendicular to the rear bumper
- Objects generating excessive noise, such as vehicle horns, loud motorcycle engines or truck air brakes, are near your vehicle
- An ultrasonic sensor with similar frequency is near your vehicle
- There is ground height difference between the vehicle and the pedestrian
- The image of the pedestrian in the rear view camera is indistinguishable from the background

- The pedestrian is near the rear edge of the vehicle
- The pedestrian is not standing upright
- The pedestrian is either very short or very tall for Reverse Parking Collision-Avoidance Assist to detect
- The pedestrian or cyclist is wearing clothing that easily blends into the background, making it difficult to detect
- The pedestrian is wearing clothing that does not reflect ultrasonic waves well
- Size, thickness, height, or shape of the object does not reflect ultrasonic waves well (for example, pole, bush, curbs, carts, edge of a wall, etc.)
- The pedestrian or the object is moving
- The pedestrian or the object is very close to the rear of the vehicle
- A wall is behind the pedestrian or the object
- The object is not located at the rear center of your vehicle
- The object is not parallel to the rear bumper
- The road is slippery or inclined
- The driver backs up the vehicle immediately after shifting to R (Reverse)
- The driver accelerates or circles the vehicle

Reverse Parking Collision-Avoidance Assist may unnecessarily warn the driver or assist with braking even if there are no pedestrians or objects under the following circumstances:

- Any non-factory equipment or accessory is installed
- Your vehicle is unstable due to an accident or other causes
- Bumper height or rear ultrasonic sensor installation has been modified
- Your vehicle height is low or high due to heavy loads, abnormal tire pressure, etc.
- Rear view camera or the rear ultrasonic sensor(s) is stained with foreign material, such as snow, dirt, etc.
- The pattern on the road is mistaken for a pedestrian
- There is shadow or light reflecting on the ground
- Pedestrians or objects are around the path of the vehicle
- Objects generating excessive noise, such as vehicle horns, loud motorcycle engines or truck air brakes, are near your vehicle
- Your vehicle is backing towards a narrow passage or parking space
- Your vehicle is backing towards an uneven road surface, such as an unpaved road, gravel, bump, gradient, etc.
- A trailer or carrier is installed on the rear of your vehicle
- An ultrasonic sensor with similar frequency is near your vehicle



WARNING

Take the following precautions when using Reverse Parking Collision-Avoidance Assist:

- Always pay extreme caution while driving. The driver is responsible for controlling the brake for safe driving.
- Always pay attention to road and traffic conditions while driving, whether or not there is a warning.
- Always look around your vehicle to make sure there are no pedestrians or objects before moving the vehicle.
- The performance of Reverse Parking Collision-Avoidance Assist may vary under certain conditions. If vehicle speed is above 4 km/h (2 mph), Reverse Parking Collision-Avoidance Assist will provide collision avoidance assist only when pedestrians are detected. Always look around and pay attention when backing up your vehicle.
- Some objects may not be detected by the rear ultrasonic sensors due to the objects distance, size or material, all of which can limit the effectiveness of the sensor.
- Reverse Parking Collision-Avoidance Assist may not operate properly or may operate unnecessarily depending on the road conditions and the surroundings.
- Do not solely rely on Reverse Parking Collision-Avoidance Assist. Doing so may lead to vehicle damage or injuries.



CAUTION

- Noise may be heard when sudden braking occurs to avoid a collision.
- If any other warning sound such as the seat belt warning chime is already generated, Reverse Parking Collision-Avoidance Assist warning may not sound.
- Reverse Parking Collision-Avoidance Assist may not work properly if the bumper has been damaged, replaced or repaired.
- Reverse Parking Collision-Avoidance Assist may not operate normally if interfered by strong electromagnetic waves.
- Playing the vehicle audio system at high volume may prevent passengers from hearing Reverse Parking Collision-Avoidance Assist warning sounds.
- Turn off Reverse Parking Collision-Avoidance Assist when towing a trailer. If towing and moving in reverse, Reverse Parking Collision-Avoidance Assist will activate as it detects the trailer.



CAUTION

Take the following precautions to maintain optimal performance of the detecting sensors:

- Always keep the rear view camera and rear ultrasonic sensors clean.
- Do not use any cleanser containing acid or alkaline detergents when cleaning the rear view camera lens. Use only a mild soap or neutral detergent, and rinse thoroughly with water.
- Do not spray the rear view camera or the rear ultrasonic sensors or their surrounding area directly with a high pressure washer. It may cause the rear view camera or the rear ultrasonic sensors to malfunction.
- Do not apply objects, such as a bumper sticker or a bumper guard, near the rear view camera or rear ultrasonic sensors or apply paint to the bumper. Doing so may adversely affect the performance of Reverse Parking Collision-Avoidance Assist.
- Never disassemble or apply impact on the rear view camera or the rear ultrasonic sensors components.
- Do not apply unnecessary force on the rear view camera or the rear ultrasonic sensors. Reverse Parking Collision-Avoidance Assist may not operate properly if the rear view camera or the rear ultrasonic sensor(s) is forcibly moved out of proper alignment. We recommend that the vehicle be inspected by an authorized retailer of Genesis Branded products.



Information

Reverse Parking Collision-Avoidance Assist can detect a pedestrian or an object when:

- A pedestrian is standing behind the vehicle
- A large obstacle, such as a vehicle, is parked in the rear center of your vehicle

REMOTE SMART PARKING ASSIST (RSPA) (IF EQUIPPED)

Remote Smart Parking Assist uses vehicle sensors to help the driver park and exit parking spaces remotely from outside the vehicle by controlling the steering wheel, vehicle speed and gearshifts.

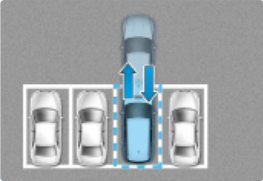
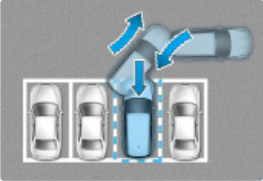
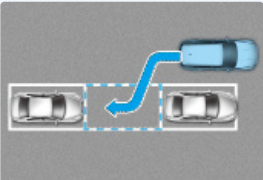
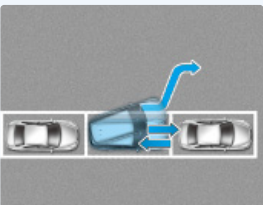
Function	Description
Remote Forward/Backward	<p>Remotely moving forward or backward</p>  <p>OJX1079037</p>
Smart Parking or Remote Smart Parking	<p>Perpendicular reverse parking</p>  <p>OJX1079034</p>
	<p>Parallel reverse parking</p>  <p>OJX1079035</p>
Smart Exit	<p>Parallel forward exit</p>  <p>OJX1079036</p>

- Remote Smart Parking and Remote Forward/Backward function may be operated from outside the vehicle using the smart key.
- Smart Parking and Remote Smart Parking function may be operated from inside the vehicle.
- Smart Parking and Remote Smart Parking function helps the driver with perpendicular reverse parking and parallel reverse parking.
- Smart Exit function helps the driver with parallel forward exit.
- When Remote Smart Parking Assist operates, Parking Distance Warning, Rear View monitor and Surround View Monitor will also operate. For more details, refer to “Parking Distance Warning (PDW)”, “Rear View Monitor (RVM)” and “Surround View Monitor (SVM)” sections in this chapter.

Detecting sensors

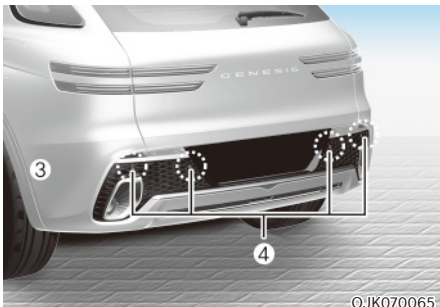
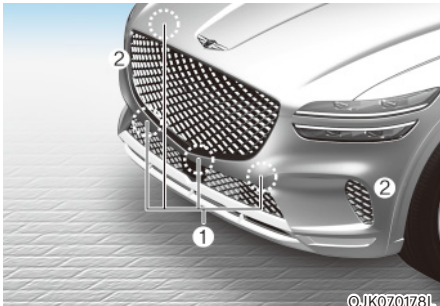

- [1] : Front ultrasonic sensors,
- [2] : Front corner ultrasonic sensors,
- [3] : Rear corner ultrasonic sensors,
- [4] : Rear ultrasonic sensors

Refer to the picture above for the detailed location of the detecting sensors.

CAUTION

Take the following precautions to maintain optimal performance of the detecting sensors:

- **Never disassemble the detecting sensor or sensor assembly, or apply any impact on it.**
- **If the detecting sensors need repair, we recommend that you have your vehicle inspected by an authorized retailer of Genesis Branded products.**

- **Remote Smart Parking Assist may malfunction if the vehicle bumper height or ultrasonic sensor installation has been modified or damaged. Any non-factory installed equipment or accessories may also interfere with the sensor performance.**
- **When the ultrasonic sensor is frozen or stained with snow, dirt, or water, the sensor may be not operate until the stains are removed using a soft cloth.**
- **Do not push, scratch or strike the ultrasonic sensor. Sensor damage could occur.**
- **Do not spray the ultrasonic sensors or its surrounding area directly with a high pressure washer.**

Remote Smart Parking Assist settings

Settings features

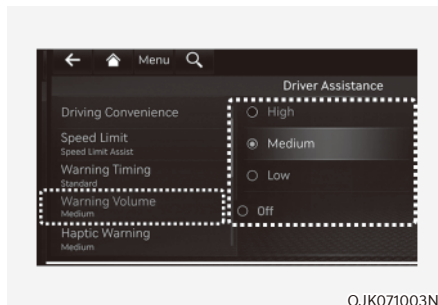

Warning Volume

With the engine on, select 'Driver Assistance → Warning Volume' from the Settings menu to change the Warning Volume to 'High', 'Medium', 'Low' or 'Off' for Remote Smart Parking Assist.





However, even if 'Off' is selected, the volume will not turn off but the volume will sound as 'Low'.

If you change the Warning Volume, the warning volume of other Driver Assistance systems may change.

Remote Smart Parking Assist operation

Remote Smart Parking Assist button



Location	Name	Symbol	Description
Inside vehicle	Parking/View button		<ul style="list-style-type: none"> Press and hold the Parking/View button to turn on Remote Smart Parking Assist. Also, Forward/Reverse Parking Distance warning will automatically turn on. However, functions may differ depending on the situations. Refer to each function's description for more details in the following pages. Press and hold the Parking/View button while Smart Parking or Smart Exit function is on to operate the function.
	Parking Safety button		<ul style="list-style-type: none"> Press the Parking Safety button while Remote Smart Parking Assist is operating to end Remote Smart Parking Assist operation.
Smart key	Remote Start button		<ul style="list-style-type: none"> Press the Remote Start button after the door is locked with the engine off to start the engine remotely. Press the Remote Start button while Remote Smart Parking or Remote Forward/Backward function is operating to end function operation.
	Forward button		<ul style="list-style-type: none"> When using Remote Smart Parking function, regardless of which direction button is pressed, parking is supported while the button is pressed.
	Backward button		<ul style="list-style-type: none"> When using the Remote Forward/Backward function, the vehicle moves in the direction of the button while the button is pressed.

Remote Forward/Backward

Operating order

Remote Forward/Backward operates in the following order:

1. Getting ready to remotely move forward and backward
2. Remotely moving forward and backward

1. Getting ready to remotely move forward and backward

There are two ways to operate Remote Forward/Backward function.

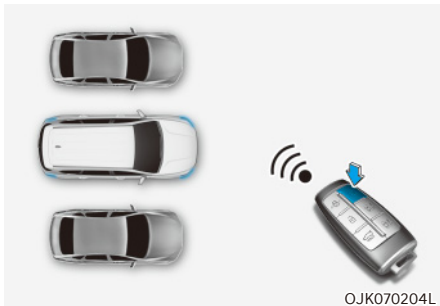

Method (1) Using the function with engine off

- (1) Within a certain range from the vehicle press the door lock (🔒) button on the smart key and lock all doors.
 - (2) Press and hold the Remote Start button (🔑) within 4 seconds until the engine starts.
- For more details on remotely starting the engine, refer to “Remote Start” section in chapter 6.

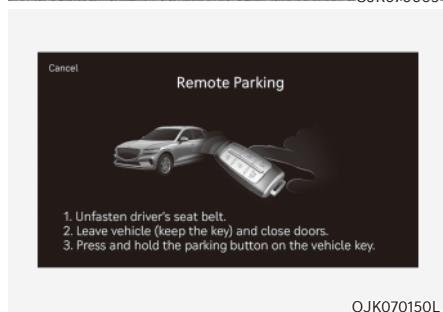
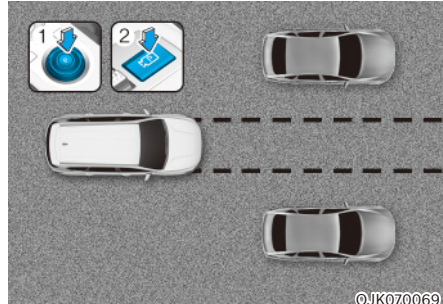

Method (2) Using the function with engine on

- (1) Park the vehicle in front of the space where you want to use Remote Forward/Backward function, and shift the gear to P (Park).
- (2) Press and hold the Parking/View (P) button to turn on Smart Parking Assist. A message ‘Under Remote Control’ will appear on the infotainment system screen.
- (3) Get out of the vehicle with the smart key and close all doors.

- 'Agree' must be selected on the infotainment system screen and the infotainment system has to operate properly to use Remote Forward/Backward function.
- Method (2) can be used after the vehicle has been driven above 5 km/h (3 mph).
- If the function is turned on again after parallel parking is completed by Remote Smart Parking Assist, Remote Forward/Backward function can be used with Method (2).
- Check that all smart keys are outside the vehicle when using Remote Forward/Backward function.

2. Remotely moving forward and backward

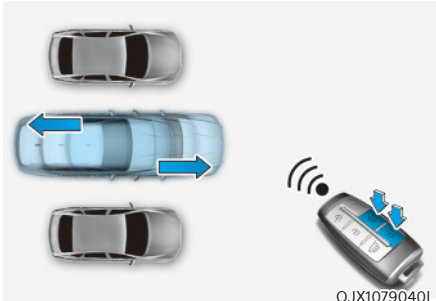

- (1) Press and hold one of the Forward (F) or Backward (B) button on the smart key. Remote Smart Parking Assist will automatically control the steering wheel, vehicle speed and gearshift. The vehicle will move in the direction of the button pressed.
 - (2) While Remote Forward/Backward function is operating, if you do not hold down the Forward (F) or Backward (B) button, the vehicle will stop and function control will pause. The function will start operating again when the button is pressed and held again.
 - (3) When the vehicle reaches the target location, release the smart key Forward or Backward button.
 - (4) When the driver gets in the vehicle with the smart key, a message will appear informing the driver Remote Forward/Backward function is complete on the infotainment system screen and the engine will remain on.
- In addition, when the Remote Start (HOLD) button is pressed on the smart key from outside the vehicle, a message will appear informing the driver Remote Forward/Backward function is complete and the engine will turn off.

- Check that all smart keys are outside the vehicle when using Remote Forward/Backward function.
- Remote Forward/Backward function will operate only when the smart key is within 4 m (13 ft.) from the vehicle. If there is no vehicle movement even when the Forward or Backward button is pressed on the smart key, check the distance to the vehicle and press the button again.
- The detecting range of the smart key may vary depending on the surroundings that are affected by radio waves such as transmission tower, broadcast station, etc.
- When remotely moving forward using method (1), it is recognized as an exit situation, and the vehicle moves 4 m (13 ft.) to check for pedestrians, animals or objects around the vehicle. After confirmation, the steering wheel is controlled according to the condition ahead.
- When remotely moving forward using method (2), it is recognized as a parking situation, and will immediately control the steering wheel according to the condition ahead to assist with entering the parking space and aligning the vehicle. However, performance may reduce depending on the pedestrians, animals, shape of objects, location, etc., around the vehicle.
- For moving remotely backward, both method (1) and (2) aligns the steering wheel first, and then will only move the vehicle straight.
- When remotely moving forward or backward is completed, the vehicle will automatically shift to P (Park) and engage EPB (Electronic Parking Brake).



CAUTION

- **When using Remote Forward/Backward function, make sure that all passengers have gotten out of the vehicle.**
- **If the vehicle's battery is discharged or Remote Smart Parking Assist malfunctions when parked in a narrow parking space, Remote Forward/Backward function will not operate. Always park your vehicle in a space wide enough for you to get in or out of your vehicle.**
- **Please note that depending on the parking space, you may not be able to exit from the space you have entered by using Remote Forward/Backward function.**
- **After parking, the surrounding may change due to the movement of surrounding vehicles. If this occurs, Remote Forward/Backward function may not operate.**
- **Before leaving the vehicle, close windows and sunroofs, and make sure the engine is off before locking the doors.**

Remote Forward/Backward function operation status

Operation status	Smart key LED	Hazard warning light
Under control	Green LED continuously blinks	-
Pause	Red LED continuously blinks	Blinks
Off	Red LED illuminates for 4 seconds and then turns off	Blinks 3 times and turns off
Complete	Green LED illuminates for 4 seconds and then turns off	Blinks 1 time and turns off

- * Operation status by the hazard warning light may not be applicable based on the regulation of your country.
- * If the smart key is not within the operating range from the vehicle (approximately 4m (13 ft.)), the smart key LED will not illuminate or blink. Use the smart key within the operating range.

How to turn off Remote Forward/Backward function while operating

- Press the Parking/View (P) button while the infotainment system screen guides the driver using method 2.
- Shift the gear except to P (Park) while the infotainment system screen guides the driver using method 2.
- Press the Parking Safety (P) button or select 'Cancel' on the infotainment system screen.
- Press the Remote Start (HOLD) button on the smart key while the vehicle is being controlled by Remote Forward/Backward function. Remote Forward/Backward function will turn off. At this time, the engine will turn off.
- Get on the vehicle with the smart key. Remote Forward/Backward function will turn off. At this time, the engine will remain on.

The function will pause in the following conditions when:

- There is a pedestrian, animal or object in the direction the vehicle is moving
- The door or tailgate is open
- The Forward (F) or Backward (B) button is not continuously pressed
- Simultaneously pressing multiple buttons on a smart key
- The smart key is not operated within 4 m (13 ft.) from the vehicle
- Button of another smart key is pressed in addition to the operating smart key
- Blind-Spot Collision-Avoidance Assist or Rear Cross-Traffic Collision-Avoidance Assist operates while the vehicle is being controlled in the reverse direction.

- The vehicle moves 7 m (22 ft.) while the smart key is pressed with Remote Forward/Backward function (maximum travel distance per button press)

When Remote Forward/Backward function is paused, the vehicle will stop. If the condition that made the function to pause disappears, the function may operate again.

The function will cancel in the following conditions when:

- The steering wheel is steered
 - The gear is shifted while the vehicle is moving
 - Operating EPB while the vehicle is moving
 - The engine hood is open
 - The brake pedal or accelerator pedal is depressed when all the doors are closed
 - The smart key is outside the vehicle when the brake pedal is depressed while the driver's door is open
 - Rapid acceleration occurs
 - Vehicle skid occurs
 - The wheel is stuck by an obstacle and cannot move
- Approximately 3 minutes and 50 seconds have past after Remote Forward/Backward function has started to operate
 - The slope of the road exceeds the operational range
 - The function is paused for more than 1 minute
 - The total travel distance of the vehicle has exceeded 14 m (45 ft.) after Remote Forward/Backward function operation
 - The steering wheel, gearshift, braking, and drive controls are not working normally
 - There is a problem with the smart key or the smart key battery is low
 - ABS, TCS or ESC system operates due to slippery road conditions
 - The alarm of the Theft Alarm System sounds

When Remote Forward/Backward function is canceled, the vehicle will automatically stop, shift the gear to P (Park) and engage EPB (Electronic Parking Brake).

Smart Parking, Remote Smart Parking

Operating order

Parking function operates in the following order:

1. Getting ready for parking
 2. Searching for parking space
 3. Select parking type and operating mode
 4. Smart Parking
 5. Remote Smart Parking
- Parking function includes Smart Parking and Remote Smart Parking.

1. Getting ready for parking

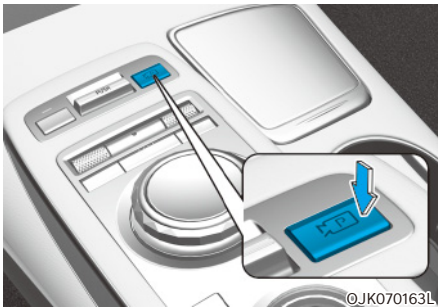

- (1) With the engine turned on, depress the brake pedal and shift the gear to D (Drive) or N (Neutral).
 - (2) Press and hold the Parking/View (P) button to turn on Remote Smart Parking Assist.
- 'Agree' must be selected on the infotainment system screen and the infotainment system has to operate properly to use Parking function.
 - If you drive above 5 km/h (3 mph) with the engine on, you may use the Parking function with the gear shifted to N (Neutral).

2. Searching for parking space

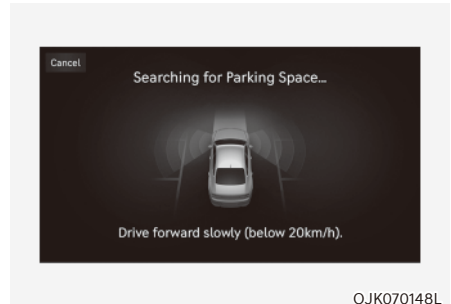

- (1) Slowly drive forward maintaining the distance of approximately 100 cm (40 in.) from the parked vehicles.
- (2) When searching for a parking space is complete, a message will appear on the infotainment system screen with an audible sound to notify the search is complete.
- (3) 'Select Parking Type' will be displayed on the infotainment system screen and the selected parking space will appear on Top View screen of Surround View Monitor.

- Remote Smart Parking Assist searches for parking spaces that are next to parked vehicles, or parking spaces with parked vehicles in front or rear.
- While searching for a parking space, when vehicle speed is above 20 km/h (12 mph), a message will appear on the infotainment system screen informing you to slow down. When vehicle speed is above 30 km/h (18 mph), Parking function will turn off.
- Searching for a parking space will be completed when there is enough space to move the vehicle in addition to the parking space.
- Even if an audible sound is heard to notify that searching for a parking space is complete, search completion can be canceled immediately depending on surroundings.

i Information

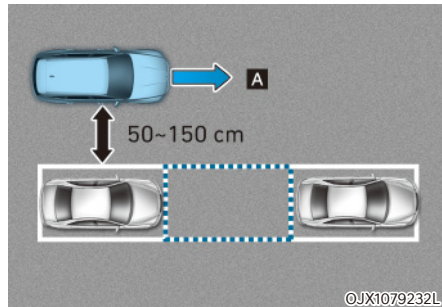

[A] : Searching for parking space

- **If the distance is below 50 cm (20 in.) or over 150 cm (59 in.), Remote Smart Parking Assist may not be able to search for a parking space.**
- **If you do not maintain a certain distance from the parked vehicle, the performance to search for a parking space may reduce.**
- **Even if a diagonal parking space is searched as a parking space, parking is not assisted normally.**
- **Due to abnormal performance of the ultrasonic sensor or the influence of the surroundings, Parking function may not be able to search for a parking space even if there is a parking space, or may search for a space that is not suitable for parking.**

3. Select parking type and operating mode

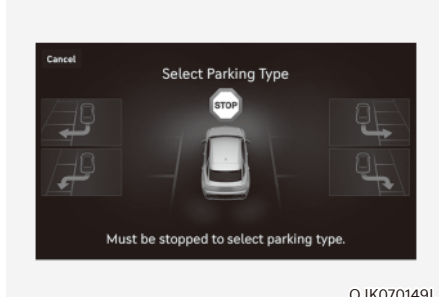

OJK070149L

- (1) Parking type – Perpendicular reverse (Left/Right), Parallel reverse (Left/Right)

With the vehicle stopped by depressing the brake pedal, touch the infotainment system screen or use the central controller to select the desired parking type.

- If you continue to drive without stopping after the parking type selection screen appears, Remote Smart Parking Assist will return to the previous stage and search for a parking space.
- If Parking function is canceled unintentionally by pressing the Parking/View (P) button before the parking type is selected, you can return to the parking type selection stage by pressing and holding the button again while the vehicle is stopped.



CAUTION

Before selecting the Parking type, the driver should check whether the parking space is suitable.

If the searched parking space by Remote Smart Parking Assist is narrow or unsuitable for parking, do not select the Parking type and move the vehicle to search for another parking space.

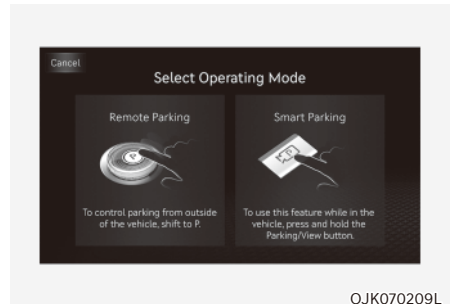

OJK070209L

- (2) Operating mode – Remote Parking, Smart Parking

After selecting a parking type, the infotainment system screen will guide you with Remote Smart Parking function and Smart Parking function. Follow the instructions to operate Remote Smart Parking Assist.

- Operating instructions will be displayed on the screen for each desired function you select.
- Do not take your foot off the brake pedal during the Parking function guide. When the vehicle moves, Remote Smart Parking Assist will turn off.

i Information



If Remote Smart Parking Assist cannot activate Remote Smart Parking function, only the Smart Parking guide will be displayed on the infotainment system screen.

4. Smart Parking

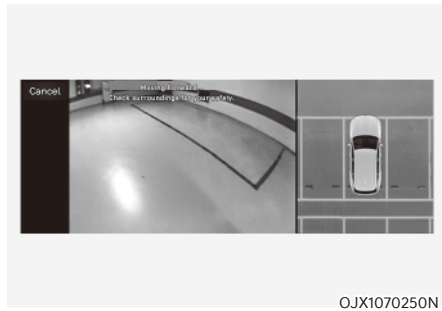

- (1) Press the Parking/View (P) button when the vehicle is stopped by depressing the brake pedal. When the brake pedal is released, Remote Smart Parking Assist will automatically control the steering wheel, vehicle speed and gearshift.
- (2) While Smart Parking function is operating, if you do not hold down the Parking/View button, the vehicle will stop and function control will pause. The function will start operating again when the Parking/View button is pressed and held again.
- (3) When the vehicle reaches the target parking position, a message will appear on the infotainment system screen to inform you that parking is complete.

- Smart Parking function will not operate if the door is open or the seat belt is not fastened.
- The parking location indicator is displayed on Surround View Monitor screen and is displayed until the vehicle enters the parking space for the first time by Smart Parking function.
- Vehicle speed can be adjusted by depressing the brake pedal while Smart Parking function is operating. However, the vehicle does not accelerate even when the accelerator pedal is depressed.
- Depending on parking environments, if the vehicle is stopped by a stopper, parking may be completed.
- If you need to change the vehicle's position or location, manually complete parking your vehicle.

5. Remote Smart Parking



OJK070150L

- (1) Shift the gear to P (Park), get out of the vehicle with the smart key, and close all doors.
- (2) Press and hold one of the Forward (⏪) or Backward (⏩) button on the smart key. Remote Smart Parking Assist will automatically control the steering wheel, vehicle speed and gearshift.
- (3) While Remote Smart Parking function is operating, if you do not hold down the Forward (⏪) or Backward (⏩) button, the vehicle will stop and function control will pause. The function will start operating again when the button is pressed and held again.
- (4) When the vehicle reaches the target parking position, a message will appear on the infotainment system screen to inform you that parking is complete. The vehicle will automatically shift to P (Park), engage EPB (Electronic Parking Brake) and the engine will turn off.



- When operating Remote Smart Parking function, make sure all smart keys are outside of the vehicle.
- Remote Smart Parking function will operate only when the smart key is within 4 m (13 ft.) from the vehicle. If there is no vehicle movement even when the Remote Forward or Backward button is pressed on the smart key, check the distance to the vehicle and press the button again.
- The detecting range of the smart key may vary depending on the surroundings that are affected by radio waves such as transmission tower, broadcast station, etc.
- The parking location indicator is displayed on Surround View Monitor screen and is displayed until the vehicle enters the parking space for the first time by Remote Smart Parking function.
- Depending on parking environments, if the vehicle is stopped by a stopper, parking may be completed.
- If you need to change the vehicle's position or location, manually complete parking your vehicle.



CAUTION

- **When using Remote Smart Parking function, make sure that all passengers have gotten out of the vehicle.**
- **After ending or turning off Remote Smart Parking function, before leaving the vehicle, close windows and sunroofs, and make sure the engine is off before locking the doors.**

How to turn off Parking function while operating

- Press the Parking/View () button in the following stage:
 - Searching for parking space
 - Select parking type
- Shift the gear to R (Reverse) in the following stage:
 - Searching for parking space
 - Select parking type
 - Select operating mode
- Press the Parking Safety () button or select 'Cancel' on the infotainment system screen to turn off Parking function.
- While Smart Parking function is operating:
 - If the vehicle is stopped by depressing the brake pedal, and the gear is shifted, Parking function will turn off. At this time, EPB (Electronic Parking Brake) will not be engaged.
- While Remote Smart Parking function is operating:
 - Press the Remote Start () button on the smart key. Parking function will turn off.
 - Get on the vehicle with the smart key. Parking function will turn off. At this time, the engine will remain on.

Parking function operation status

- Smart Parking function

Operation status	Turn signal
Under control	The turn signal of the parking direction blinks until the first reverse is complete.

- Smart Parking function

Operation status	Smart key LED	Hazard warning light	Turn signal
Under control	Green LED continuously blinks	-	The turn signal of the parking direction blinks until the first reverse is complete.
Pause	Red LED continuously blinks	Blinks	-
Off	Red LED illuminates for 4 seconds and then turns off	Blinks 3 times and turns off	-
Complete	Green LED illuminates for 4 seconds and then turns off	Blinks 1 time and turns off	-

* Operation status by the hazard warning light may not be applicable based on the regulation of your country.

* If the smart key is not within the operating range from the vehicle (approximately 4m (13 ft.)), the smart key LED will not illuminate or blink. Use the smart key within the operating range.

The function will pause in the following conditions when:

- Smart Parking
 - There is a pedestrian, animal or object in the direction the vehicle is moving
 - The door or tailgate is open
 - The driver's seat belt is not fastened
 - Blind-Spot Collision-Avoidance Assist or Rear-Cross Traffic Collision Assist operates while the vehicle is being controlled in the reverse direction
 - The Parking/View (P) button is not continuously pressed
 - The vehicle is stopped by depressing the brake pedal
- Remote Smart Parking
 - There is a pedestrian, animal or object in the direction the vehicle is moving
 - The door or tailgate is open
 - The Forward (F) or Backward (B) button is not continuously pressed
 - Simultaneously pressing multiple buttons on a smart key
 - The smart key is not operated within 4 m (13 ft.) from the vehicle
 - Button of another smart key is pressed in addition to the operating smart key
 - Blind-Spot Collision-Avoidance Assist or Rear-Cross Traffic Collision Assist operates while the vehicle is being controlled in the reverse direction

When Parking function is paused, the vehicle will automatically stop. If the condition that made the function to pause disappears, the function may operate again.

The function will cancel in the following conditions when:

- Smart Parking
 - The steering wheel is steered
 - The gear is shifted while the vehicle is moving
 - Operating EPB while the vehicle is moving
 - The engine hood is open
 - The driver opens the door with the seatbelt unfastened
 - Rapid acceleration occurs
 - Vehicle skid occurs
 - The wheel is stuck by an obstacle and cannot move
 - There are pedestrians, animals or objects at the front and rear of the vehicle at the same time
 - Approximately 3 minutes and 50 seconds have past after Smart Parking function has started to operate
 - The slope of the road exceeds the operational range
 - The function is paused for more than 1 minute
 - The steering wheel, gearshift, braking, and drive controls are not working normally
 - ABS, TCS or ESC system operates due to slippery road conditions

When Smart Parking function is canceled, the vehicle will automatically stop, shift the gear to P (Park) and engage EPB (Electronic Parking Brake).

- Remote Smart Parking
 - The steering wheel is steered
 - The gear is shifted
 - Operating EPB while the vehicle is moving
 - The engine hood is open
 - The brake pedal or accelerator pedal is depressed when all the doors are closed
 - The smart key is outside the vehicle when the brake pedal is depressed while the driver's door is open.
 - Rapid acceleration occurs
 - Vehicle skid occurs
 - The wheel is stuck by an obstacle and cannot move
 - There are pedestrians, animals or objects at the front and rear of the vehicle at the same time
 - Approximately 3 minutes and 50 seconds have past after Remote Smart Parking function has started to operate
 - The slope of the road exceeds the operational range
 - The function is paused for more than 1 minute
 - The steering wheel, gearshift, braking, and drive controls are not working normally
 - There is a problem with the smart key or the smart key battery is low
 - ABS, TCS or ESC system operates due to slippery road conditions
 - The alarm of the Theft Alarm System sounds

When Remote Smart Parking function is canceled, the vehicle will automatically stop, shift the gear to P (Park) and engage EPB (Electronic Parking Brake).

Smart Exit

Operating order

Smart Exit function operates in the following order:

1. Getting ready for exit
2. Checking space
3. Select exit direction
4. Smart Exit

1. Getting ready for exit



- (1) With the engine turned on, depress the brake pedal and shift the gear to P (Park) or N (Neutral).
- (2) Press and hold the Parking/View (P) button to turn on Remote Smart Parking Assist.
 - 'Agree' must be selected on the infotainment system screen and the infotainment system has to operate properly to use Smart Smart Exit function.
 - Drive below 5 km/h (3 mph) with the engine on and shift the gear to N (Neutral), Smart Exit function can be used.
 - If the function is turned on again after parallel parking is completed by Remote Smart Parking Assist, Smart Exit function can be used.

2. Checking space

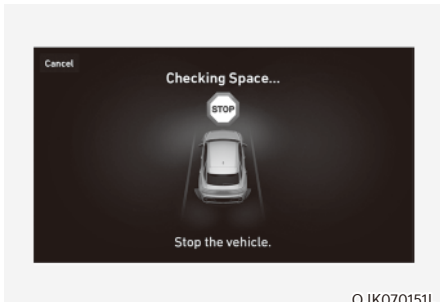

OJK070151L

- (1) When the vehicle is stopped by depressing the brake pedal, the vehicle sensors will detect the distance from nearby objects and check for space to exit.
- (2) When checking for space is complete, a message will appear on the infotainment system screen with an audible sound to notify the search is complete.

WARNING

- While checking for space, if there is a risk of collision with pedestrian, animal or object in the direction of vehicle exit, for your safety, Smart Exit function can be turned off.
- Even if check for space is completed, objects in the blind spot area cannot be detected by the sensors. The driver must directly check the blind spot area and continue using the function.

Information

Due to abnormal performance of the ultrasonic sensor or the influence of the surroundings, Parking function may not be able to search for a parking space even if there is a parking space, or may search for a space that is not suitable for parking.

- The parked vehicle has objects attached to the bumper such as bumper guard, trailer hitch, etc.

3. Select exit direction

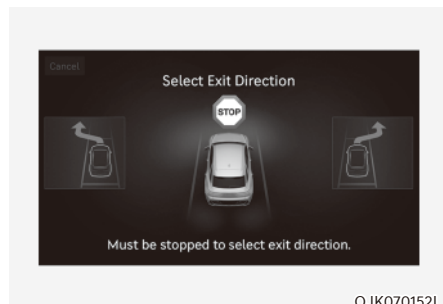

OJK070152L

- (1) With the vehicle stopped by depressing the brake pedal, the infotainment system screen displays the possible directions for parallel exit.
- (2) Touch the infotainment system screen or use the central controller to select the desired exit direction.

CAUTION

- Before selecting the Exit Direction, the driver should check whether the space for exit is suitable.
- If the searched exit space by Remote Smart Parking Assist is narrow or unsuitable (surrounding vehicles are parked vertically, etc.), do not use the Smart Exit function.

4. Smart Exit

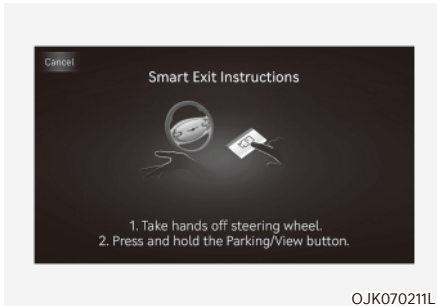

- (1) Press the Parking/View () button when the vehicle is stopped by depressing the brake pedal. When the brake pedal is released, Remote Smart Parking Assist will automatically control the steering wheel, vehicle speed and gearshift.
 - (2) While Smart Exit function is operating, if you do not hold down the Parking/View button, the vehicle will stop and function control will pause. The function will start operating again when the Parking/View button is pressed and held again.
 - (3) When the vehicle reaches the target exit location, a message will appear on the infotainment system screen to inform you that exit is complete.
- Smart Exit function will not operate if the door is open or the seat belt is not fastened.
 - Vehicle speed can be adjusted by depressing the brake pedal while Smart Exit function is operating. However, the vehicle does not accelerate even when the accelerator pedal is depressed.
 - If exit is completed while depressing the brake pedal, Smart Exit function will complete with the gear in D (Drive).
 - If exit is completed while depressing the accelerator pedal, you must take your foot off the accelerator pedal once for the accelerator pedal to operate.
 - If there is no vehicle operation such as depressing the brake pedal or accelerator pedal within 4 seconds after exit is complete, the vehicle will automatically shift to P (Park) and engage EPB (Electronic Parking Brake).
 - After Exit function is complete, always check the surroundings before driving.

Smart Exit operation status

Operation status	Turn signal
Under control	The turn signal of the exit direction blinks until the exit is complete or Smart Exit is canceled.

How to turn off Smart function while operating

- Press the Parking/View (P) button in the following stage:
 - Checking space
 - Select exit direction
- Shift the gear to R (Reverse) in the following stage:
 - Checking space
 - Select exit direction
- Press the Parking Safety (P) button or select 'Cancel' on the infotainment system screen to turn off Exit function.
- While Smart Exit function is operating, if the vehicle is stopped by depressing the brake pedal, and the gear is shifted, Exiting function will turn off. At this time, EPB (Electronic Parking Brake) will not be engaged.

The function will pause in the following conditions when:

- There is a pedestrian, animal or object in the direction the vehicle is moving
- The door or tailgate is open
- The driver's seat belt is not fastened
- Blind-Spot Collision-Avoidance Assist or Rear-Cross Traffic Collision Assist operates while the vehicle is being controlled in the reverse direction
- The Parking/View (P) button is not continuously pressed
- The vehicle is stopped by depressing the brake pedal

When Exit function is paused, the vehicle will stop. If the condition that made the function to pause disappears, the function may operate again.

The function will cancel in the following conditions when:

- Smart Exit
 - The steering wheel is steered
 - The gear is shifted while the vehicle is moving
 - Operating EPB while the vehicle is moving
 - The engine hood is open
 - The driver opens the door with the seatbelt unfastened
 - Rapid acceleration occurs
 - Vehicle skid occurs
 - The wheel is stuck by an obstacle and cannot move
 - There are pedestrians, animals or objects at the front and rear of the vehicle at the same time
 - Approximately 3 minutes and 50 seconds have past after Smart Exit function has started to operate
 - The slope of the road exceeds the operational range
 - The function was paused for more than 1 minute
 - The steering wheel, gearshift, braking, and drive controls are not working normally
 - ABS, TCS or ESC system operates due to slippery road conditions

When Smart Exit function is canceled, the vehicle will automatically stop, shift the gear to P (Park) and engage EPB (Electronic Parking Brake).

Remote Smart Parking Assist malfunction and limitations

Remote Smart Parking Assist malfunction

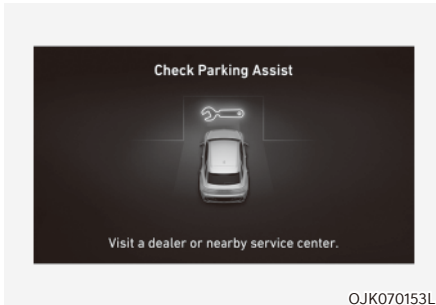

OJK070153L

Remote Smart Parking Assist check

When Remote Smart Parking Assist is not working properly, the 'Check Parking Assist' warning message will appear on the infotainment system screen. If the message appears, stop using Remote Smart Parking Assist, and we recommend that the vehicle be inspected by an authorized retailer of Genesis Branded products.

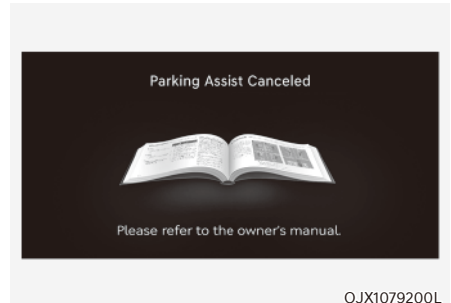

OJX1079200L

Remote Smart Parking Assist canceled

When Remote Parking Assist is operating, the function can be canceled, and the 'Parking Assist Canceled' warning message may appear regardless of the parking order. Other messages may appear depending on the situations. Follow the instructions provided on the infotainment system screen while parking your vehicle with Remote Parking Assist. Always look around and pay attention when using Remote Smart Parking Assist.

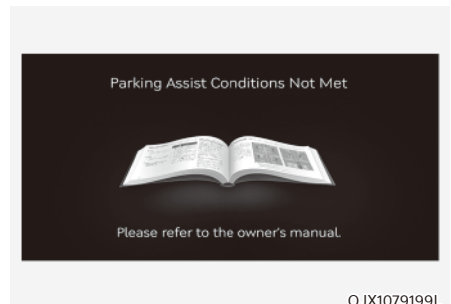

OJX1079199L

Remote Smart Parking Assist standby

When 'Parking Assist Conditions Not Met' message appears, when Parking/View (P) button has been pressed and held, Remote Smart Parking Assist is in standby. After a while, press and hold the Parking/View (P) button again to see if Remote Smart Parking Assist works.

The message appears even when the smart key's battery is low. Check the smart key battery level.

Limitations of Remote Smart Parking Assist

In the following circumstances, Remote Smart Parking Assist performance to park or exit the vehicle may be limited, there may be a risk of collision, or Remote Smart Parking Assist may turn off. Park or exit the vehicle manually if necessary.

- An object is attached to the steering wheel
- The vehicle is installed with a snow chain, spare tire or different size wheel
- Tire pressure is lower or higher than the standard tire pressure
- Your vehicle is loaded with cargo longer or wider than your vehicle or a trailer is connected to your vehicle
- There is a problem with the wheel alignment
- Your vehicle is leaned severely to one side
- Your vehicle is equipped with a trailer hitch
- The license plate is installed differently from the original location
- There is a person, animal or object above or below the ultrasonic sensor when Remote Smart Parking Assist is activated
- The parking space is curved or diagonal
- There is an obstacle such as a person, animal or object (trash can, bicycle, motorcycle, shopping cart, narrow pillar, etc.) near the parking space
- There is a circular pillar or narrow pillar, or a pillar surrounded by objects such as fire extinguisher, etc., near the parking space
- The road surface is bumpy (curbstone, speed bump, etc.)
- The road is slippery
- The parking space is near a vehicle with higher ground clearance or big, such as a truck, etc.
- The parking space is Inclined
- There is heavy wind
- Operating Remote Smart Parking Assist on uneven roads, gravel roads, bushes, etc.
- The performance of the ultrasonic sensor is affected by extremely hot or cold weather
- The ultrasonic sensor is covered with snow or water
- An object that generates ultrasonic waves is nearby
- A wireless device with a transmission function operates near the ultrasonic sensors
- Your vehicle is affected by another vehicle's Parking Distance Warning
- The sensor is mounted or positioned incorrectly by an impact to the bumper
- When the ultrasonic sensor cannot detect the following objects:
 - Sharp or slim objects, such as ropes, chains or small poles
 - Objects smaller than 100 cm (40 in.) in length and narrower than 14 cm (6 in.) in diameter
 - Objects which tend to absorb sensor frequency, such as clothes, spongy material or snow

Remote Smart Parking Assist may not operate normally under the following circumstances:

- Parking on inclines



Park manually when parking on inclines.

- Parking in snow



Snow may interfere with sensor operation, or Remote Smart Parking Assist may cancel if the road is slippery while parking.

- Parking on uneven road



Remote Smart Parking Assist may cancel when the vehicle slips, or the vehicle cannot move due to road conditions such as pebbles or fragmented stones.

- Parking behind a truck

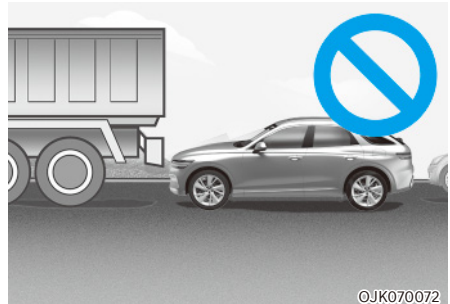

Do not use Remote Smart Parking Assist around vehicles with higher ground clearance, such as a bus, truck, etc. It may lead to an accident.

- Parking near a pillar

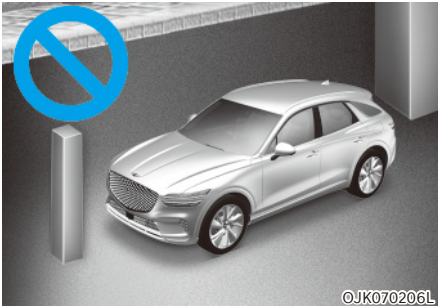

Remote Smart Parking Assist performance may reduce or collision with an obstacle may occur when there is a narrow object, circular pillar, square pillar, or a pillar surrounded by objects such as a fire extinguisher, etc., near the parking space. The driver should park the vehicle manually.

- Parking in a parking space with a vehicle on one side only

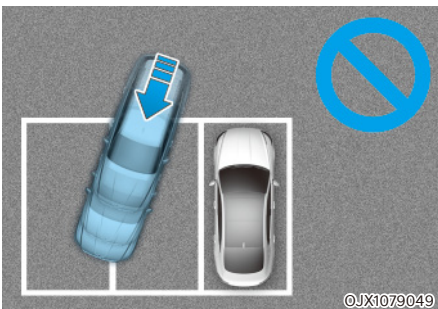

If Remote Smart Parking Assist is used, when parking in a parking space with a vehicle only on one side, your vehicle may cross the parking line to avoid the parked vehicle.

- Parking diagonal

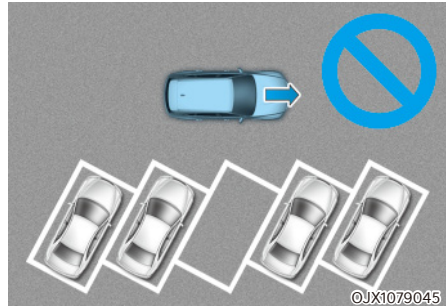

Remote Smart Parking Assist does not provide diagonal parking. Even if your vehicle was able to enter the parking space, do not use Remote Smart Parking Assist because the function cannot operate normally.

- Leaving a parking space near a wall or parking in a narrow space

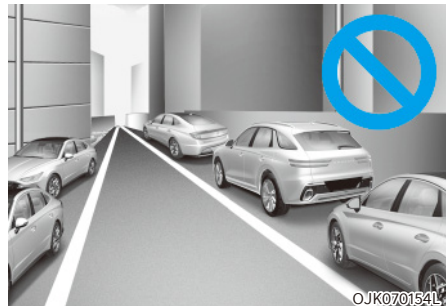

- Remote Smart Parking Assist may not operate properly when leaving a parking space that is narrow and near a wall. Always check for pedestrians, animals, objects while leaving.
- For your safety, Remote Smart Parking Assist does not search for parking spaces at areas with narrow parking spaces that are narrower than the minimum space required for parking.



WARNING

Take the following precautions when using Remote Smart Parking Assist:

- The driver is responsible for safe parking and exit when using Remote Smart Parking Assist.
- When using Remote Smart Parking Assist, stay out of the way in the direction the vehicle moves for your safety.
- Always check surroundings when using Remote Smart Parking Assist. You may collide with pedestrians, animals, or objects if they are near the sensor or are in the sensor's blind spot area.
- A collision may occur if a pedestrian, animal, or object suddenly appears while Remote Smart Parking Assist is operating.
- Do not use Remote Smart Parking Assist when under the influence of alcohol.
- Do not let children or other people to use the smart key.
- If Remote Smart Parking Assist is used continuously for a long period, it may adversely affect Remote Smart Parking Assist performance.
- Remote Smart Parking Assist may not operate normally if the vehicle needs wheel alignment adjustment such as when the vehicle tilts to one side. We recommend that the vehicle be inspected by an authorized retailer of Genesis Branded Products.
- Noise may be heard when braking occurs by Remote Smart Parking Assist or when the brake pedal is depressed by the driver.
- Remote Smart Parking Assist may suddenly apply the brake to avoid collision.
- Use Remote Smart Parking Assist only in a parking space that is large enough for the vehicle to move safely.

NOTICE

- If the 3rd stage warning (continuous beep) of the Forward/Reverse Parking Distance Warning sounds while Remote Smart Parking Assist is operating, it means the obstacle detected is close to your vehicle. At this time, Remote Smart Parking Assist will temporarily stop operating. Make sure there are no pedestrians, animals, or objects around your vehicle.
- Depending on brake operation, the stop lights may come on while the vehicle is moving.
- If the vehicle is remotely started that has been parked in cold weather for a long time, the operation of Remote Smart Parking function may be delayed or cancelled depending on vehicle condition.

DECLARATION OF CONFORMITY (IF EQUIPPED)

Front radar

The radio frequency components (Rear Corner Radar) complies:

- For Europe and CE certified countries



Model : LRR-25

Hereby LRR-25 has been so constructed that it can be operated in at least one Member State without infringing applicable requirements of use of radio spectrum. (RED article 10.2)

Hereby, Mando Corp declares that the radio equipment type LRR-25 is in compliance with Directive 2014/53/EU.

The full text of the EU declaration of conformity is available at the following internet address:
<https://www.mando.com/md/md04.jsp>

OANATEL285

- For Australia



OANATEL287

- For United Arab Emirates



OANATEL288

- For Brazil



OANATEL289

- For Serbia



- For Ukraine



- For Moldova



- For Oman



- For Israel



- For Mexico

IFETEL : RCPMALR19-1603

"La operación de este equipo está sujeta a las siguientes dos condiciones:
(1) es posible que este equipo o dispositivo no cause interferencia perjudicial y
(2) este equipo o dispositivo debe aceptar cualquier interferencia, incluyendo la que pueda causar su operación no deseada."
and RCPMALR19-1603

OANATEL295

- For Singapore

**Complies with
IMDA Standards
[Dealer's Licence No.]**

Dealer number : DA107248

OANATEL298

- For Jordan

Model : LRR-25 (Mando)

OANATEL296

- For Russia



OANATEL299

- For Malaysia



HIDF16000136

OANATEL297

Rear corner radar

The radio frequency components (Rear Corner Radar) complies:

- For Taiwan



電信法第 48 條, 低功率電波輻射性電機管理辦法

第十二條

經型式認證合格之低功率射頻電機, 非經許可, 公司、商號或使用者均不得擅自變更頻率、加大功率或變更原設計之特性及功能。

第十四條

低功率射頻電機之使用不得影響飛航安全及干擾合法通信; 經發現有干擾現象時, 應立即停用, 並改善至無干擾時方得繼續使用。

前項合法通信, 指依電信法規定作業之無線電通信。低功率射頻電機須忍受合法通信或工業、科學及醫療用電波輻射性電機設備之干擾。

Article 12

Without permission, any company, firm or user shall not alter the frequency, increase the power, or change the characteristics and functions of the original design of the certified lower power frequency electric machinery.

Article 14

The application of low power frequency electric machineries shall not affect the navigation safety nor interface a legal communication, if an interference is found, the service will be suspended until improvement is made and the interference no longer exist.

OANATEL055

- For Indonesia

59903/SDPPI/2019
8837

OANATEL056

- For Malaysia



OANATEL057

- For Singapore

Complies with
IMDA Standards
DA 103787

OANATEL058

- For Mexico

IFETEL: RCPAPJ419-0206

“La operación de este equipo está sujeta a las siguientes dos condiciones:
(1) es posible que este equipo o dispositivo no cause interferencia perjudicial y
(2) este equipo o dispositivo debe aceptar cualquier interferencia, incluyendo la que pueda causar su operación no deseada.”

OANATEL059

- For Ukraine



UA RF: IAPTIV J4TR

справжнім (найменування виробника) заявляє, що тип радіобладнання (позначення типу радіобладнання) в ідповідає Технічному регламенту радіобладнання;

повний текст декларації про в ідповідність доступний на веб-сайті з а такою адресою:
www.apativ.com/automotive-homologation

OANATEL060

- Moldova



OANATEL061

- Jordan

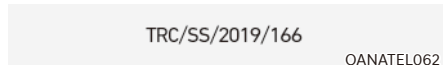

OANATEL062

- Untied Arab Emirates

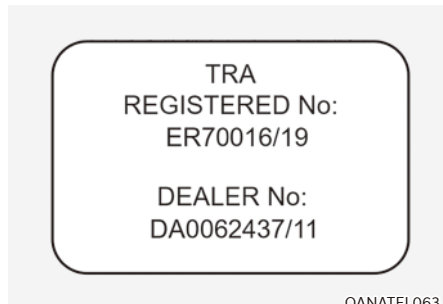

OANATEL063

- Ghana

NCA approved: BR3-1M-GE2-003

OANATEL064

- Serbia and Montenegro



OANATEL066

- Republic of South Africa



OANATEL065

- For Europe and CE certified countries

Declaration of Conformity
Radiocontrolled Vehicle components



Hereby, APTIV, 42367 Wuppertal declares that this J4TR/J4TRh is in compliance with the essential requirements and other relevant provisions of Directive 2014/53/EU (RED).

The original declaration of conformity can be accessed at the following link : www.aptiv.com/automotive-homologation

frequency band 76-77 GHz
Maximum Output Power 30 dBm (1,0 W)

OANATEL116

- For Paraguay



OANATEL117

8. Emergency situations

Hazard warning flasher.....	8-3
In case of an emergency while driving.....	8-3
If the engine stalls while driving	8-3
If the engine stalls at a crossroad or crossing	8-3
If you have a flat tire while driving	8-4
If the engine will not start	8-4
Jump starting	8-5
If the engine overheats.....	8-8
Tire Pressure Monitoring System (TPMS).....	8-9
Check tire pressure	8-10
Tire pressure monitoring system.....	8-10
Low tire pressure warning light.....	8-11
Low tire pressure position and tire pressure telltale.....	8-11
TPMS (Tire Pressure Monitoring System) malfunction indicator.....	8-12
Changing a tire with TPMS	8-13
If you have a flat tire (with spare tire).....	8-14
Jack and tools.....	8-14
Changing tires	8-15
Jack label.....	8-20
EC declaration of conformity for jack.....	8-21
If you have a flat tire (with Tire Mobility Kit)	8-22
Introduction.....	8-22
Notes on the safe use of the Tire Mobility Kit	8-23
Components of the Tire Mobility Kit.....	8-24
Using the Tire Mobility Kit	8-25
Checking the tire inflation pressure.....	8-28
Towing	8-29
Towing service.....	8-29
Removable towing hook.....	8-30
Emergency towing	8-31

Emergency commodity	8-34
Fire extinguisher.....	8-34
First aid kit	8-34
Triangle reflector	8-34
Tire pressure gauge.....	8-34
Pan-European eCall System (FOR EUROPE).....	8-35
Information on data processing (FOR EUROPE).....	8-37
Pan-European eCall System (FOR EUROPE)	8-38
UAE ECALL System (FOR UAE).....	8-42
Information on data processing (FOR UAE)	8-44
UAE ECALL System (FOR UAE).....	8-45

HAZARD WARNING FLASHER

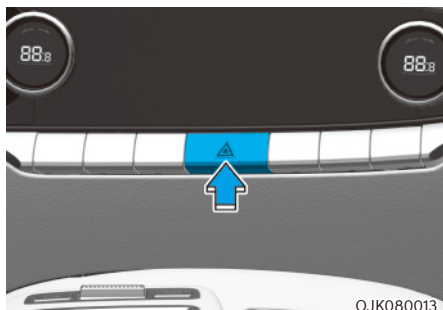

The hazard warning flasher serves as a warning to other drivers to exercise extreme caution when approaching, overtaking, or passing your vehicle.

It should be used whenever emergency repairs are being made or when the vehicle is stopped near the edge of a roadway.

To turn the hazard warning flasher on or off, press the hazard warning flasher button with the Engine Start/Stop button in any position. The hazard warning flasher button is located in the center fascia panel. All turn signal lights will flash simultaneously.

- The hazard warning flasher operates regardless of whether your vehicle is running or not.
- The turn signals do not work when the hazard flasher is on.

IN CASE OF AN EMERGENCY WHILE DRIVING

If the engine stalls while driving

- Reduce your speed gradually, keeping a straight line. Move cautiously off the road to a safe place.
- Turn on your hazard warning flasher.
- Try to start the engine again. If your vehicle will not start, we recommend that you contact an authorized retailer of Genesis Branded products or seek other qualified assistance.

If the engine stalls at a crossroad or crossing

If the engine stalls at a crossroads or crossing, if safe to do so, shift the gear to N (Neutral) and then push the vehicle to a safe location.

If you have a flat tire while driving

If a tire goes flat while you are driving:

- Take your foot off the accelerator pedal and let the vehicle slow down while driving straight ahead. Do not apply the brakes immediately or attempt to pull off the road as this may cause loss of vehicle control resulting in an accident. When the vehicle has slowed to such a speed that it is safe to do so, brake carefully and pull off the road. Drive off the road as far as possible and park on firm, level ground. If you are on a divided highway, do not park in the median area between the two traffic lanes.
- When the vehicle is stopped, press the hazard warning flasher button, shift the gear to P (Park), apply the parking brake, and press the Engine Start/Stop button to the OFF position.
- Have all passengers get out of the vehicle. Be sure they all get out on the side of the vehicle that is away from traffic.
- When changing a flat tire, follow the instructions provided later in this chapter.

IF THE ENGINE WILL NOT START

- Be sure to shift the gear to N (Neutral) or P (Park). The engine starts only when the gear is in N (Neutral) or P (Park).
- Turn on the interior light. If the light dims or goes out when you operate the starter, the battery is drained.

See instructions for “Jump Starting” provided in this chapter.

- Check the fuel level and add fuel if necessary.

If the vehicle still does not start, we recommend that you call an authorized retailer of Genesis Branded products for assistance.

NOTICE

Push or pull starting the vehicle may cause the catalytic converter to overload which can lead to damage to the emission control system.

JUMP STARTING

Jump starting can be dangerous if done incorrectly. Follow the jump starting procedure in this section to avoid serious injury or damage to your vehicle. If in doubt about how to properly jump start your vehicle, we strongly recommend that you have a service technician or towing service do it for you.



WARNING

To prevent **SERIOUS INJURY** or **DEATH** to you or bystanders, always follow these precautions when working near or handling the battery:



Always read and follow instructions carefully when handling a battery.



Wear eye protection designed to protect the eyes from acid splashes.



Keep all flames, sparks, or smoking materials away from the battery.



Hydrogen is always present in battery cells, is highly combustible, and may explode if ignited.



Keep batteries out of reach of children.



Batteries contain sulfuric acid which is highly corrosive. Do not allow acid to contact your eyes, skin or clothing.

If acid gets into your eyes, flush your eyes with clean water for at least 15 minutes and get immediate medical attention. If acid gets on your skin, thoroughly wash the area. If you feel pain or a burning sensation, get medical attention immediately.

- When lifting a plastic-cased battery, excessive pressure on the case may cause battery acid to leak. Lift with a battery carrier or with your hands on opposite corners.
- Do not attempt to jump start your vehicle if your battery is frozen.
- NEVER attempt to recharge the battery when the vehicle's battery cables are connected to the battery.
- The electrical ignition system works with high voltage.

NEVER touch these components with the engine running or when the Engine Start/Stop button is in the ON position.

Jump starting procedure

i Information

Your vehicle has a battery in the luggage compartment, but when you jump start your vehicle, use the jumper terminal in the engine compartment.

1. Position the vehicles close enough that the jumper cables will reach, but do not allow the vehicles to touch.
2. Avoid fans or any moving parts in the engine compartment at all times, even when the vehicles are turned off.
3. Turn off all electrical devices such as radios, lights, air conditioning, etc. Put the vehicles in P (Park) and set the parking brake. Turn both vehicles OFF.
4. Open the engine hood.

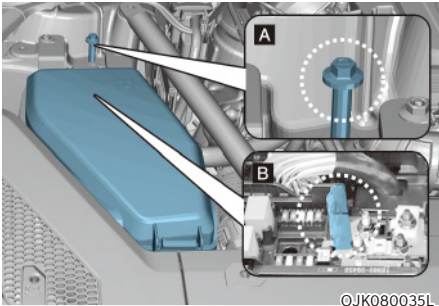

[A] : Negative (-) Terminal,
[B] : Positive (+) Terminal

5. Remove the engine compartment fuse box cover.

! CAUTION

Before jump starting, make sure to correctly identify the positive (+) and negative (-) terminals to avoid reverse polarity connections.

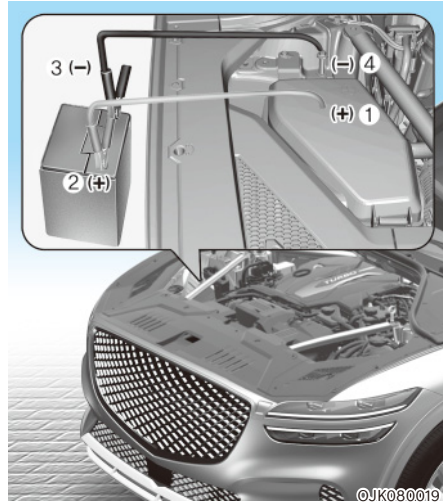

6. Connect the jumper cables in the exact sequence shown in the illustration. First connect one jumper cable to the red, positive (+) jumper terminal of your vehicle (1).
7. Connect the other end of the jumper cable to the red, positive (+) battery/jumper terminal of the assisting vehicle (2).
8. Connect the second jumper cable to the black, negative (-) battery/jumper terminal of the assisting vehicle (3).
9. Connect the other end of the second jumper cable to the black, negative (-) chassis ground of your vehicle (4).

Do not allow the jumper cables to contact anything except the correct battery or jumper terminals or the correct ground. Do not lean over the battery when making connections.

! WARNING

Do not connect the jumper cable to the negative (-) jumper terminal of the discharged battery. A spark could cause the battery to explode and lead to a personal injury or vehicle damage.

10. Start the engine of the assisting vehicle and let it run at approximately 2,000 RPM for a few minutes. Then start your vehicle.
11. Keep your vehicle operating for at least 30 minutes at idle or driving to assure your battery receives enough charge to be able to start on its own after the vehicle is shut off. A complete dead battery may require as long as 60 minutes runtime to fully recharge it. If vehicle is run for less, the battery may not restart.

If your vehicle will not start after a few attempts, it probably requires servicing. In this event please seek qualified assistance. If the cause of your battery discharging is not apparent, we recommend that you have your vehicle checked by an authorized retailer of Genesis Branded products.

Disconnect the jumper cables in the exact reverse order you connected them:

1. Disconnect the jumper cable from the black, negative (-) chassis ground of your vehicle (4).
2. Disconnect the other end of the jumper cable from the black, negative (-) battery/chassis ground of the assisting vehicle (3).
3. Disconnect the second jumper cable from the red, positive (+) battery/jumper terminal of the assisting vehicle (2).
4. Disconnect the other end of the jumper cable from the red, positive (+) jumper terminal of your vehicle (1).

Information



An inappropriately disposed battery can be harmful to the environment and human health. Dispose of the battery according to your local law(s) or regulations.

NOTICE

To prevent damage to your vehicle:

- Only use a 12-volt power supply (battery or jumper system) to jump start your vehicle.
- Do not attempt to jump start your vehicle by push-starting.

WARNING

While jump starting your vehicle, avoid the positive (+) and negative (-) cables to come in contact. A spark could cause personal injury.

IF THE ENGINE OVERHEATS

If your temperature gauge indicates overheating, you experience a loss of power, or hear loud pinging or knocking, the engine may be overheating. If this happens, you should:

1. Pull off the road and stop as soon as it is safe to do so.
2. Shift the gear to P (Park) and set the parking brake. If the air conditioning is ON, turn it OFF.
3. If engine coolant is running out under the vehicle or steam is coming out from the hood, stop the engine. Do not open the hood until the coolant has stopped running or the steaming has stopped. If there is no visible loss of engine coolant and no steam, leave the engine running and check to be sure the engine cooling fan is operating. If the fan is not running, turn the engine off.

WARNING

 While the engine is running, keep hands, clothing and tools away from the moving parts such as the cooling fan and drive belt to prevent serious injury.

4. Check for coolant leaking from the radiator, hoses or under the vehicle. (If the air conditioning had been in use, it is normal for cold water to be draining from it when you stop.)
5. If engine coolant is leaking out, we recommend that you stop the engine immediately and call the nearest authorized retailer of Genesis Branded products for assistance.

WARNING



Never remove the engine coolant cap and/or liquid-cooled intercooler coolant cap or the drain plug while the engine and radiator are hot.

Hot coolant and steam may blow out under pressure, causing serious injury.

Turn the engine off and wait until the engine cools down. Use extreme care when removing the coolant cap. Wrap a thick towel around it, and turn it counterclockwise slowly. Step back while the pressure is released from the cooling system. When you are sure all the pressure has been released, using a thick towel, and continue turning counterclockwise to remove it.

6. If you cannot find the cause of the overheating, wait until the engine temperature has returned to normal. Then, if coolant has been lost, carefully add coolant to the reservoir to bring the fluid level in the reservoir up to the halfway mark.
7. Proceed with caution, keeping alert for further signs of overheating. If overheating happens again, we recommend that you call an authorized retailer of Genesis Branded products for assistance.



CAUTION

- **Serious loss of coolant indicates a leak in the cooling system and we recommend the system be checked by an authorized retailer of Genesis Branded products.**
- **When the engine overheats from low engine coolant, suddenly adding engine coolant may cause cracks in the engine. To prevent damage, add engine coolant slowly in small quantities. It may require several refilling cycles to properly fill the engine cooling system. If necessary, an authorized retailer of Genesis Branded products should be consulted to perform this task.**

TIRE PRESSURE MONITORING SYSTEM (TPMS)

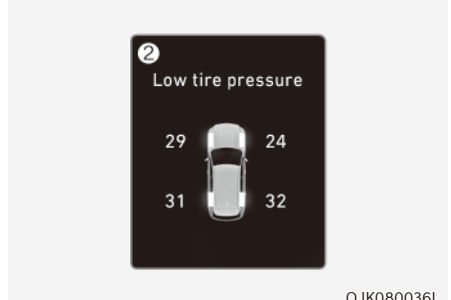
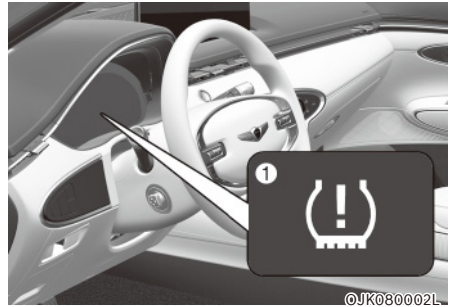

- (1) Low Tire Pressure Telltale/TPMS Malfunction Indicator
- (2) Low Tire Pressure Position Telltale and Tire Pressure Telltale (Shown on the LCD display)

Check tire pressure

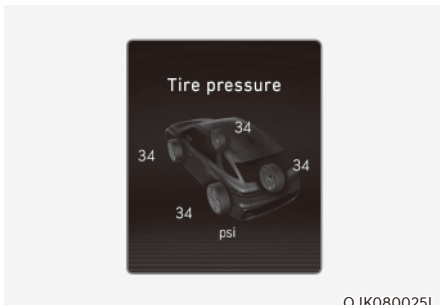

- You can check the tire pressure in the Utility view on the cluster.
Refer to the “View Modes” section in chapter 4.
- Tire pressure is displayed after a few minutes of driving after initial vehicle start up.
- If tire pressure is not displayed when the vehicle is stopped, ‘Drive to display’ message will appear. After driving, check the tire pressure.
- The displayed tire pressure values may differ from those measured with a tire pressure gauge.
- You can change the tire pressure unit from the Settings menu in the infotainment system screen. Select:
 - Setup → General Settings → Unit → Tire Air Pressure Unit → psi/kPa/bar

For detailed information, scan the QR code in the separately supplied simple manual.

Tire pressure monitoring system

WARNING

Over-inflation or under-inflation can reduce tire life, adversely affect vehicle handling, and lead to sudden tire failure that may cause loss of vehicle control resulting in an accident.

Each tire, including the spare (if provided), should be checked monthly when cold and inflated to the inflation pressure recommended by the vehicle manufacturer on the vehicle placard or tire inflation pressure label. (If your vehicle has tires of a different size than the size indicated on the vehicle placard or tire inflation pressure label, you should determine the proper tire inflation pressure for those tires.)

As an added safety feature, your vehicle has been equipped with a tire pressure monitoring system (TPMS) that illuminates a low tire pressure telltale when one or more of your tires is significantly under-inflated. Accordingly, when the low tire pressure telltale illuminates, you should stop and check your tires as soon as possible, and inflate them to the proper pressure. Driving on a significantly under-inflated tire causes the tire to overheat and can lead to tire failure.

Under-inflation also reduces fuel efficiency and tire tread life, and may affect the vehicle’s handling and stopping ability.

Please note that the TPMS is not a substitute for proper tire maintenance, and it is the driver’s responsibility to maintain correct tire pressure, even if under-inflation has not reached the level to trigger illumination of the TPMS low tire pressure telltale.

Your vehicle has also been equipped with a TPMS malfunction indicator to indicate when the system is not operating properly. The TPMS malfunction indicator is combined with the low tire pressure telltale. When the system detects a malfunction, the telltale will flash for approximately one minute and then remain continuously illuminated. This sequence will continue upon subsequent vehicle start-ups as long as the malfunction exists.

When the malfunction indicator is illuminated, the system may not be able to detect or signal low tire pressure as intended. TPMS malfunctions may occur for a variety of reasons, including the installation of replacement or alternate tires or wheels on the vehicle that prevent the TPMS from functioning properly.

Always check the TPMS malfunction telltale after replacing one or more tires or wheels on your vehicle to ensure that the replacement or alternate tires and wheels allow the TPMS to continue to function properly.

NOTICE

If any of the below happens, we recommend that you have the system checked by an authorized retailer of Genesis Branded products.

1. **The Low Tire Pressure Telltale/ TPMS Malfunction Indicator does not illuminate for 3 seconds when the Engine Start/Stop button is pressed to the ON position or when the engine is running.**
2. **The TPMS Malfunction Indicator remains illuminated after blinking for approximately 1 minute.**
3. **The Low Tire Pressure Position Telltale remains illuminated.**



Low tire pressure warning light

Low tire pressure position and tire pressure telltale

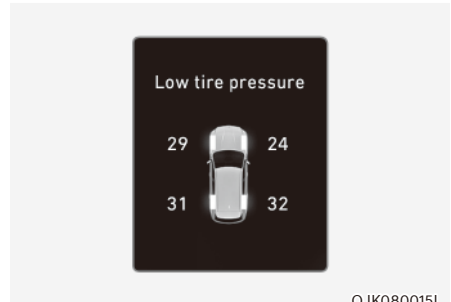

When the tire pressure monitoring system warning indicators are illuminated and a warning message displayed on the cluster LCD display, one or more of your tires is significantly under-inflated. The Low Tire Pressure Position Telltale will indicate which tire is significantly underinflated by illuminating the corresponding position light.

If either telltale illuminates, immediately reduce your speed, avoid hard cornering and anticipate increased stopping distances. You should stop and check your tires as soon as possible. Inflate the tires to the proper pressure as indicated on the vehicle's placard or tire inflation pressure label located on the driver's side center pillar outer panel.

If you cannot reach a service station or if the tire cannot hold the newly added air, replace the low pressure tire with the spare tire.

The Low Tire Pressure Telltale will remain on and the TPMS Malfunction Indicator may blink for one minute and then remain illuminated (when the vehicle is driven approximately 10 minutes at speed above 25 km/h (15.5 mph)) until you have the low pressure tire repaired and replaced on the vehicle.



CAUTION

In winter or cold weather, the Low Tire Pressure Telltale may be illuminated if the tire pressure was adjusted to the recommended tire inflation pressure in warm weather. It does not mean your TPMS is malfunctioning because the decreased temperature leads to a proportional lowering of tire pressure.

When you drive your vehicle from a warm area to a cold area or from a cold area to a warm area, or the outside temperature is greatly higher or lower, you should check the tire inflation pressure and adjust the tires to the recommended tire inflation pressure.



WARNING

Low pressure damage

Significantly low tire pressure makes the vehicle unstable and can contribute to loss of vehicle control and increased braking distances.

Continued driving on low pressure tires can cause the tires to overheat and fail.



TPMS (Tire Pressure Monitoring System) malfunction indicator

The TPMS Malfunction Indicator will illuminate after it blinks for approximately one minute when there is a problem with the Tire Pressure Monitoring System.

We recommend that the system be checked by an authorized retailer of Genesis Branded products as soon as possible.

NOTICE

If there is a malfunction with the TPMS, the Low Tire Pressure Position Telltale will not be displayed even though the vehicle has an under-inflated tire.

NOTICE

The TPMS Malfunction Indicator may illuminate after blinking for one minute if the vehicle is near electric power supply cables or radio transmitters such as police stations, government and public offices, broadcasting stations, military installations, airports, transmitting towers, etc.

Additionally, the TPMS Malfunction Indicator may illuminate if snow chains are used or electronic devices such as computers, chargers, remote starters, navigation, etc. This may interfere with normal operation of the TPMS.

Changing a tire with TPMS

If you have a flat tire, the Low Tire Pressure and Position telltales will come on. We recommend that the flat tire be repaired by an authorized retailer of Genesis Branded products as soon as possible or replace the flat tire with the spare tire.

NOTICE

It is recommended that you do not use a puncture-repairing agent not approved by an authorized retailer of Genesis Branded products or the equivalent specified for your vehicle to repair and/or inflate a low pressure tire. Tire sealant not approved by an authorized retailer of Genesis Branded or the equivalent specified for your vehicle may damage the tire pressure sensor.

The spare tire (if equipped) does not come with a tire pressure monitoring sensor. When the low pressure tire or the flat tire is replaced with the spare tire, the Low Tire Pressure Telltale will remain on. Also, the TPMS Malfunction Indicator will illuminate after blinking for one minute if the vehicle is driven at speed above 25 km/h (15.5 mph) for approximately 10 minutes.

Once the original wheel equipped with a tire pressure monitoring sensor is reinflated to the recommended pressure and reinstalled on the vehicle, the Low Tire Pressure Telltale and TPMS Malfunction Indicator will go off within a few minutes of driving.

If the indicators do not extinguish after a few minutes, please visit an authorized retailer of Genesis Branded products.

Each wheel is equipped with a tire pressure sensor mounted inside the tire behind the valve stem (except for the spare tire). You must use TPMS specific wheels. It is recommended that you always have your tires serviced by an authorized retailer of Genesis Branded products.

You may not be able to identify a tire with low pressure by simply looking at it. Always use a good quality tire pressure gauge to measure. Please note that a tire that is hot (from being driven) will have a higher pressure measurement than a tire that is cold.

A cold tire means the vehicle has been sitting for 3 hours and driven for less than 1.6 km (1 mile) in that 3 hour period.

Allow the tire to cool before measuring the inflation pressure. Always be sure the tire is cold before inflating to the recommended pressure.



WARNING

- **The TPMS cannot alert you to severe and sudden tire damage caused by external factors such as nails or road debris.**
- **If you feel any vehicle instability, immediately take your foot off the accelerator, apply the brakes gradually with light force, and slowly move to a safe position off the road.**

⚠ WARNING

Tampering with, modifying, or disabling the Tire Pressure Monitoring System (TPMS) components may interfere with the system's ability to warn the driver of low tire pressure conditions and/or TPMS malfunctions. Tampering with, modifying, or disabling the Tire Pressure Monitoring System (TPMS) components may void the warranty for that portion of the vehicle.

⚠ WARNING

For Europe

- Do not modify the vehicle; it may interfere with the TPMS function.
- The wheels on the market do not have a TPMS sensor.

For your safety, we recommend that you use parts for replacement from an authorized retailer of Genesis Branded products.

- If you use the wheels on the market, use a TPMS sensor approved by an authorized retailer of Genesis Branded products or the equivalent approved for your vehicle. If your vehicle is not equipped with a TPMS sensor or TPMS does not work properly, you may fail the periodic vehicle inspection conducted in your country.

IF YOU HAVE A FLAT TIRE (WITH SPARE TIRE, IF EQUIPPED)

⚠ WARNING

Changing a tire can be dangerous. Follow the instructions in this section when changing a tire to reduce the risk of serious injury or death.

⚠ CAUTION

Be careful as you use the jack handle to stay clear of the flat end. The flat end has sharp edges that could cause cuts.

Jack and tools

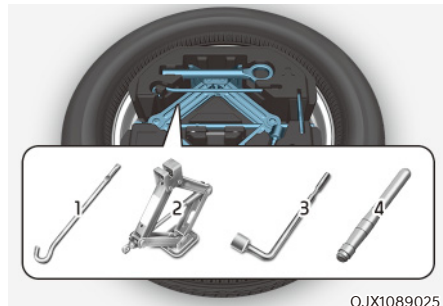

1. Jack handle
2. Jack
3. Wheel lug wrench
4. Centering pin

The jack, jack handle, and wheel lug wrench are stored in the luggage compartment under the luggage box cover.

The jack is provided for emergency tire changing only.



OJX1089026

Turn the winged hold down bolt counterclockwise to remove the spare tire.

Store the spare tire in the same compartment by turning the winged hold down bolt clockwise.

To prevent the spare tire and tools from “rattling”, store them in their proper location.



OJX1089027

If it is hard to loosen the tire hold-down wing bolt by hand, you can loosen it easily using the wheel lug wrench (1). Turn the tire hold-down wing bolt counterclockwise with the wheel lug wrench.

Changing tires

WARNING

A vehicle can slip or roll off of a jack causing serious injury or death to you or those nearby. Take the following safety precautions:

- Do not get under a vehicle that is supported by a jack.
- **NEVER** attempt to change a tire in the lane of traffic. **ALWAYS** move the vehicle completely off the road on level, firm ground away from traffic before trying to change a tire. If you cannot find a level, firm place off the road, call a towing service for assistance.
- Be sure to use the jack provided with the vehicle.
- **ALWAYS** place the jack on the designated jacking positions on the vehicle and **NEVER** on the bumpers or any other part of the vehicle for jacking support.
- Do not start or run the engine while the vehicle is on the jack.
- Do not allow anyone to remain in the vehicle while it is on the jack.
- Keep children away from the road and the vehicle.

Follow these steps to change your vehicle's tire:

1. Park on a level, firm surface.
2. Shift the gear to P (Park), apply the parking brake, and press the Engine Start/Stop button to the OFF position.
3. Press the hazard warning flasher button.
4. Remove the wheel lug wrench, jack, jack handle, and spare tire from the vehicle.



OJK080026L

[A] : Block

5. Block both the front and rear of the tire diagonally opposite of the tire you are changing.

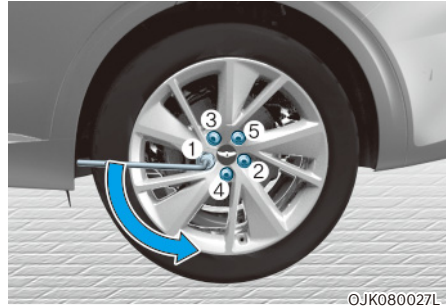

OJK080027L

6. Loosen the wheel bolts counterclockwise one turn each in the order shown above, but do not remove any wheel bolts until the tire has been raised off of the ground.

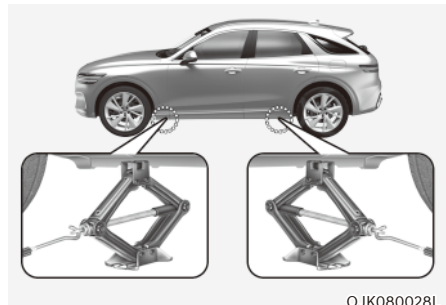

OJK080028L

7. Place the jack at the designated jacking position under the frame closest to the tire you are changing. The jacking positions are plates welded to the frame with two notches. Never jack at any other position or part of the vehicle. Doing so may damage the side seal molding or other parts of the vehicle.



8. Insert the jack handle into the jack and turn it clockwise, raising the vehicle until the tire clears the ground. Make sure the vehicle is stable on the jack.
9. Loosen a wheel bolt with the wheel lug wrench and remove it with your fingers.



10. Insert the centering pin (1) into the hole where the wheel bolt is removed. Remove rest of the wheel bolts from the wheel.
11. Remove the wheel from the studs and lay it flat on the ground out of the way. Remove any dirt or debris from the studs, mounting surfaces, and wheel.

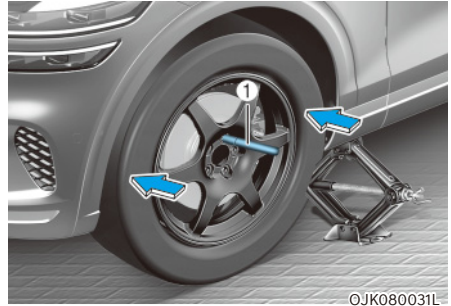

12. Install the spare tire over the centering pin (1) and then push in the spare tire.
13. Tighten the wheel bolts with your fingers onto the studs with the smaller end of the wheel bolts closest to the wheel.
14. Pull out the centering pin (1) and tighten the last wheel bolt.
15. Lower the vehicle to the ground by turning the jack handle counterclockwise.

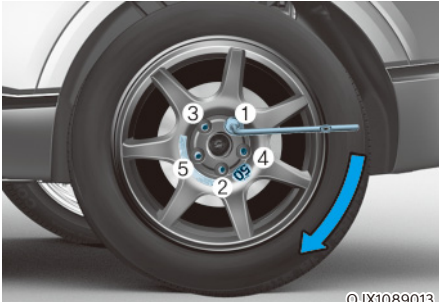

16. Use the wheel lug wrench to tighten the wheel bolts in the order shown. Double-check each wheel bolts until they are tight. After changing tires, we recommend that an authorized retailer of Genesis Branded products tighten the wheel bolts to their proper torque as soon as possible. **The wheel bolt should be tightened to 14~16 kgf.m (101~116 lbf.ft).**

If you have a tire gauge, check the tire pressure (see “Tires and Wheels” section in chapter 2 for tire pressure instructions.). If the pressure is lower or higher than recommended, drive slowly to the nearest service station and adjust it to the recommended pressure. Always reinstall the valve cap after checking or adjusting tire pressure. If the cap is not replaced, air may leak from the tire. If you lose a valve cap, buy another and install it as soon as possible. After changing tires, secure the flat tire and return the jack and tools to their proper storage locations.

NOTICE

Check the tire pressure as soon as possible after installing a spare tire. Adjust it to the recommended pressure.

CAUTION

Your vehicle has metric threads on the studs and wheel bolts. Make certain during tire changing that the same bolts that were removed are reinstalled. If you have to replace your wheel bolts make sure they have metric threads to avoid damaging the studs and ensure the wheel is properly secured to the hub. We recommend that you consult an authorized retailer of Genesis Branded products for assistance.

If any of the equipment such as the jack, wheel bolts, studs, or other equipment is damaged or in poor condition, do not attempt to change the tire and call for assistance.

Use of compact spare tires (if equipped)

Compact spare tires are designed for emergency use only. Drive carefully on the compact spare tire and always follow the safety precautions.



WARNING

To prevent compact spare tire failure and loss of control possibly resulting in an accident:

- Use the compact spare tire only in an emergency.
- NEVER operate your vehicle over 80 km/h (50 mph).
- Do not exceed the vehicle's maximum load rating or the load carrying capacity shown on the sidewall of the compact spare tire.
- Do not use the compact spare tire continuously. Repair or replace the original tire as soon as possible to avoid failure of the compact spare tire.

When driving with the compact spare tire mounted to your vehicle:

- Check the tire pressure after installing the compact spare tire. The compact spare tire should be inflated to 420 kPa (60 psi).
- Do not take this vehicle through an automatic car wash while the compact spare tire is installed.
- Do not use the compact spare tire on any other vehicle because this tire has been designed especially for your vehicle.
- The compact spare tire's tread life is shorter than a regular tire. Inspect your compact spare tire regularly and replace worn compact spare tires with the same size and design, mounted on the same wheel.
- Do not use more than one compact spare tire at a time.
- Do not tow a trailer while the compact spare tire is installed.



Information

When the original tire and wheel are repaired and reinstalled on the vehicle, the wheel bolt torque must be set correctly. The correct wheel bolt tightening torque is 14~16 kgf.m (101~116 lbf.ft).

NOTICE

To prevent damaging the compact spare tire and your vehicle:

- Drive slowly enough for the road conditions to avoid all hazards, such as a potholes or debris.
- Avoid driving over obstacles. The compact spare tire diameter is smaller than the diameter of a conventional tire and reduces the ground clearance approximately 25 mm (1 inch).
- Do not use tire chains on the compact spare tire. Because of the smaller size, a tire chain will not fit properly.
- Do not use the compact spare tire on any other wheels, nor should standard tires, snow tires, wheel covers or trim rings be used with the compact spare wheel.
- Do not suddenly accelerate or decelerate (0~40 km/h) (0 ~25 mph) in any driving mode. It may cause leakage of transfer oil.

Jack label

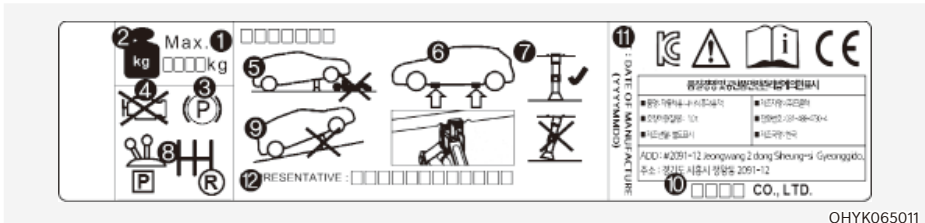

OHYK065011

The actual Jack label in the vehicle may differ from the illustration.

For more detailed specifications, refer to the label attached to the jack.

1. Model Name
2. Maximum allowable load
3. When using the jack, set your parking brake.
4. When using the jack, stop the engine.
5. Do not get under a vehicle that is supported by a jack.
6. The designated locations under the frame
7. When supporting the vehicle, the base plate of jack must be vertical under the lifting point.
8. Shift into Reverse gear on vehicles with manual transmission or shift the gear to the P position on vehicles with automatic transmission.
9. The jack should be used on firm level ground.
10. Jack manufacture
11. Production date
12. Representative company and address

EC declaration of conformity for jack



EC Declaration of Conformity according to EC Machinery Directive 2006/42/EC

We, **SAMKI IND. CO., LTD.**
22, Hyojuk3-Gil, Buk-Gu, Ulsan, Korea
declare under our sole responsibility that the product

Product : Jack Assembly
Type Designation(s) : Jack Assembly-600kg, Jack Assembly-700kg
Jack Assembly-800kg, Jack Assembly-1000kg
Jack Assembly-1200kg, Jack Assembly-1500kg
Serial No. : N/A
Year of Manufacture : 2013

to which this declaration relates is in conformity with the following standard(s) or other normative document(s):

EN ISO12100 (2010)	Safety of machinery - General principles for design – Risk assessment and risk reduction
EN ISO12100-2/A1 (2009)	Safety of machinery - Basic concepts, general principles for design, Part 2 : Technical principles
EN 1494/A1 (2008)	Mobile or movable jacks and associated lifting equipment

following the provisions of Directive(s):
2006/42/EC Directive on the approximation of the laws of Member States relating to machinery (OJ L157 Jun. 9, 2006)

Ulsan , Korea / Jul 25 ,2013 Hyun Duck, Cho President 
(Place and date of issue)(name and signature or equivalent making of authorized person)

* T.C.F Compiling Person: Safenet Limited (European Notified body : 1674)
Denford Garage, Denford, Kettering Northants, NN14 4EQ, England

IF YOU HAVE A FLAT TIRE (WITH TIRE MOBILITY KIT, IF EQUIPPED)

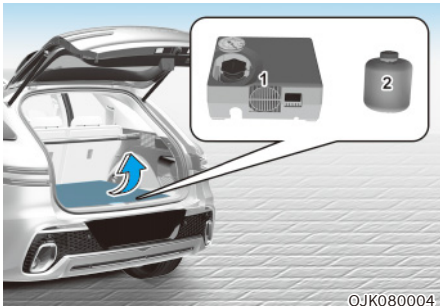

For safe operation, carefully read and follow the instructions in this manual before use.

- (1) Compressor
- (2) Sealant bottle

The Tire Mobility Kit is a temporary fix to the tire and the tire should be inspected by an authorized retailer of Genesis Branded products or the equivalent approved for your vehicle as soon as possible.



CAUTION

When two or more tires are flat, do not use the tire mobility kit because the supported one sealant of Tire Mobility Kit is only used for one flat tire.



WARNING

Do not use the Tire Mobility Kit to repair punctures in the tire walls. This can result in an accident due to tire failure.



WARNING

Have your tire repaired as soon as possible. The tire may lose air pressure at any time after inflating with the Tire Mobility Kit.

Introduction

With the Tire Mobility Kit you stay mobile even after experiencing a tire puncture.

The compressor and sealing compound system effectively and comfortably seals most punctures in a passenger car tire caused by nails or similar objects and reinflates the tire.

After you ensure that the tire is properly sealed you can drive cautiously on the tire (distance up to 200 km (120 miles)) at a max. speed of (80 km/h (50 mph)) in order to reach a service station or tire dealer for the tire replacement.

It is possible that some tires, especially with larger punctures or damage to the sidewall, cannot be sealed completely.

Air pressure loss in the tire may adversely affect tire performance.

For this reason, you should avoid abrupt steering or other driving maneuvers, especially if the vehicle is heavily loaded or if a trailer is in use.

The Tire Mobility Kit is not designed or intended as a permanent tire repair method and is to be used for one tire only.

This instruction shows you step by step how to temporarily seal the puncture simply and reliably.

Read the section “Notes on the safe use of the Tire Mobility Kit”.



WARNING

Do not use the TMK if a tire is severely damaged by driving run flat or with insufficient air pressure.

Only punctured areas located within the tread region of the tire can be sealed using the TMK.

Notes on the safe use of the Tire Mobility Kit

- Park your car at the side of the road so that you can work with the Tire Mobility Kit away from moving traffic.
- To be sure your vehicle will not move, even when you're on fairly level ground, always set your parking brake.
- Only use the Tire Mobility Kit for sealing/inflation passenger car tires. Only punctured areas located within the tread region of the tire can be sealed using the tire mobility kit.
- Do not use on motorcycles, bicycles or any other type of tires.
- When the tire and wheel are damaged, do not use Tire Mobility Kit for your safety.
- Use of the Tire Mobility Kit may not be effective for tire damage larger than approximately 4 mm (16 inch).
Please contact the nearest retailer of Genesis Branded products if the tire cannot be made roadworthy with the Tire Mobility Kit.
- Do not use the Tire Mobility Kit if a tire is severely damaged by driving run flat or with insufficient air pressure.
- Do not remove any foreign objects such as nails or screws that have penetrated the tire.
- Provided the car is outdoors, leave the engine running. Otherwise operating the compressor may eventually drain the car battery.
- Never leave the Tire Mobility Kit unattended while it is being used.
- Do not leave the compressor running for more than 10 minutes at a time or it may overheat.
- Do not use the Tire Mobility Kit if the ambient temperature is below -30°C (-22°F).
- In case of skin contact with the sealant, wash the area thoroughly with plenty of water. If the irritation persists, seek medical attention.
- In case of eye contact with the sealant, flush your eyes for at least 15 minutes. If the irritation persists, seek medical attention.
- In case of swallowing the sealant, rinse the mouth and drink plenty of water. However, never give anything to an unconscious person and seek medical attention immediately.
- Long time exposure to the sealant may cause damage to bodily tissue such as kidney, etc.

Components of the Tire Mobility Kit

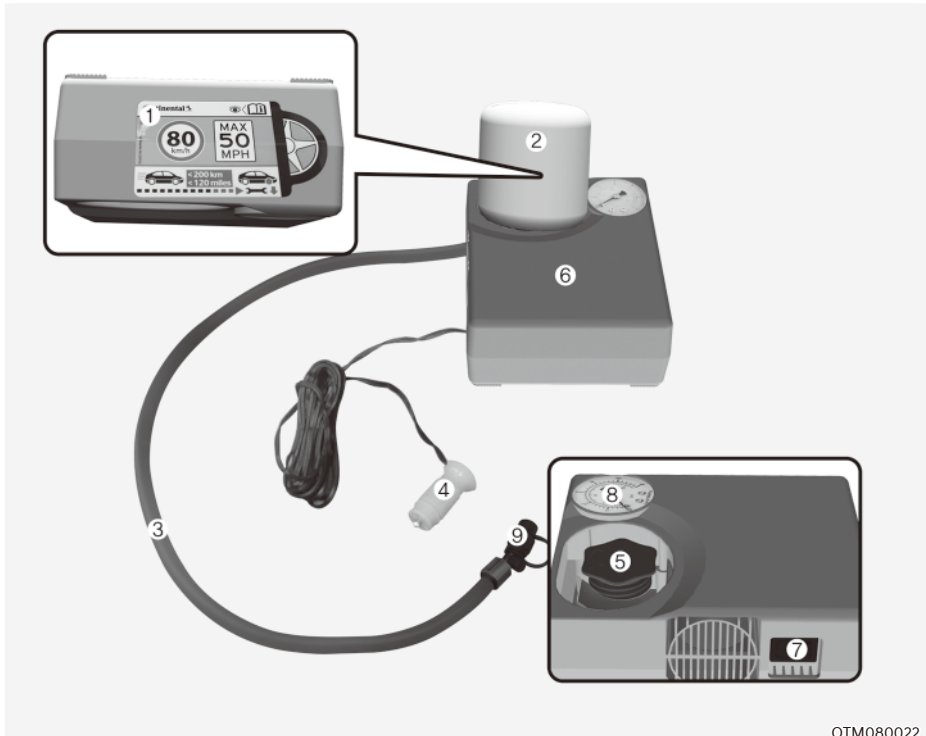

OTM080022

1. Speed restriction label
2. Sealant bottle and label with speed restriction
3. Filling hose
4. Connectors and cable for the power outlet direct connection
5. Holder for the sealant bottle
6. Compressor
7. ON/OFF switch
8. Pressure gauge for displaying the tire inflation pressure
9. Button for reducing tire inflation pressure

Connectors, cable and connection hose are stored in the compressor housing.

Strictly follow the specified sequence, otherwise the sealant may escape under high pressure.

WARNING

Do not use the tire sealant after the sealant has expired (for example, past the expiration date on the sealant container). This can increase the risk of tire failure.

WARNING

- Keep out of reach of children.
- Avoid contact with eyes.
- Do not swallow.

Using the Tire Mobility Kit

WARNING

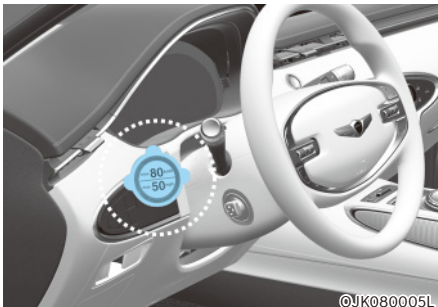

Detach the speed restriction label (1) from the sealant bottle (2), and place it in a highly visible place inside the vehicle such as on the steering wheel to remind the driver not to drive too fast.



OTM080025

1. Shake the sealant bottle (2).

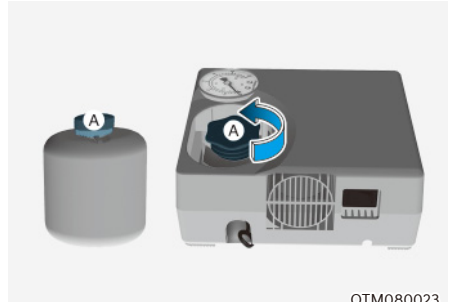

OTM080023

2. Remove the cover (A) of the sealant bottle (2) and compressor (6).



OTM080024

3. Connect the sealant bottle (2) and compressor (6).
4. Make sure that the valve (9) for reducing tire inflation pressure is closed.

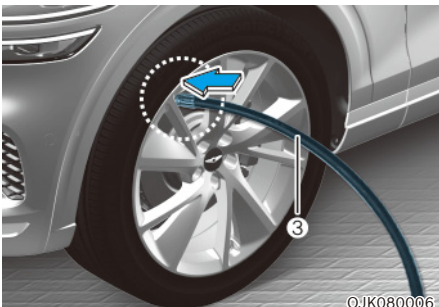

OJK080006

5. Unscrew the valve cap from the valve of the defective and screw the connection hose (3) of the compressor and tire.

NOTICE

Securely install the sealant filling hose to the valve. If not, sealant may flow backward, possibly clogging the filling hose.

6. Make sure the compressor turns off by pressing [O] of the main switch (7).

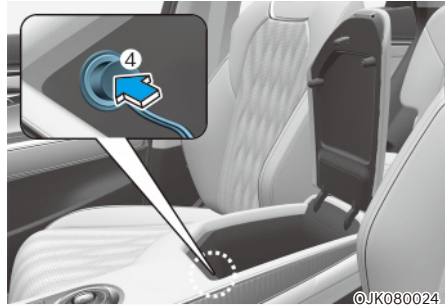

OJK080024

7. Connect the cable and connector (4) to the power outlet in the vehicle.
8. Start the vehicle.
9. With the engine running, switch on the compressor by pressing [I] and let it run for approximately 5-7 minutes to fill the sealant up to proper pressure. (Refer to "Tire and Wheels" section in chapter 2). The inflation pressure of the tire after filling is unimportant and will be checked/ corrected later.

Be careful not to overinflate the tire and stay away from the tire when filling it.

CAUTION

Do not attempt to drive your vehicle if the tire pressure is below 200 kpa (29 psi). This could result in an accident due to sudden tire failure.

10. Switch off the compressor.
11. Detach the hoses from the sealant bottle connector and from the tire valve.

Return the Tire Mobility Kit to its storage location in the vehicle.

WARNING

Do not leave your vehicle running in a poorly ventilated area for extended periods of time. Carbon monoxide poisoning and suffocation can occur.

Distributing the sealant

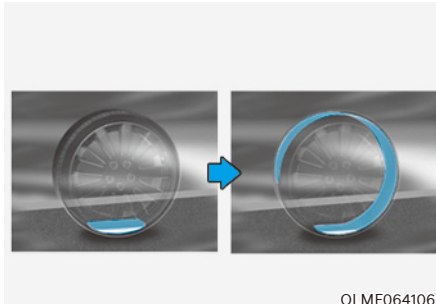

12. Immediately drive approximately 7~10 km (4~6 miles or about 10 minutes) to evenly distribute the sealant in the tire.

Do not exceed a speed of 80 km/h (50 mph). If possible, do not fall below a speed of 20 km/h (12 mph).

While driving, if you experience any unusual vibration, ride disturbance or noise, reduce your speed and drive with caution until you can safely pull off of the side of the road.

Call for road side service or towing.

13. After driving approximately 7~10 km (4~6 miles or about 10 minutes), stop at a safe location.

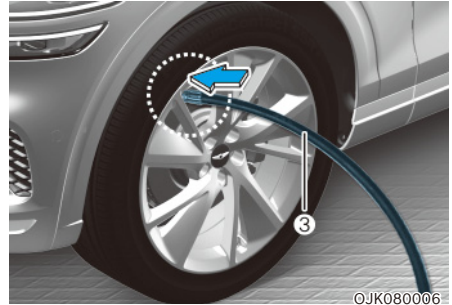

14. Connect the connection hose (3) of the compressor and tire into the tire valve.
15. Connect cables (4) to the battery.
16. Adjust the tire inflation pressure to the recommended tire inflation. With the engine running, proceed as follows.
 - **To increase the inflation pressure:**
Switch on the compressor. To check the current inflation pressure setting, briefly switch off the compressor.
 - **To reduce the inflation pressure:**
Adjust the valve (9) for reducing tire inflation pressure.

NOTICE

Do not let the compressor run for more than 10 minutes, otherwise the device will overheat and may be damaged.

Checking the tire inflation pressure

1. After driving approximately 7~10 km (4~6 miles or about 10 minutes), stop at a safe location.

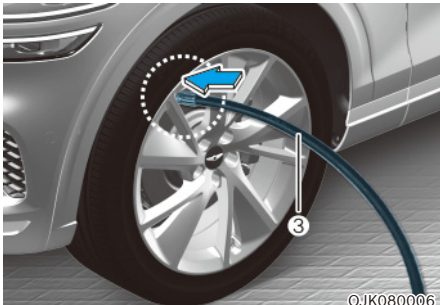

2. Connect the connection hose (3) of the compressor and tire into the tire valve.
3. Connect cables (4) to the battery.
4. Adjust the tire inflation pressure to the recommended tire inflation.

With the engine running, proceed as follows.

- **To increase the inflation pressure:**
Switch on the compressor.
To check the current inflation pressure setting, briefly switch off the compressor.
- **To reduce the inflation pressure:**
Adjust the valve (9) for reducing tire inflation pressure.

NOTICE

Do not let the compressor run for more than 10 minutes, otherwise the device will overheat and may be damaged.

i Information

The pressure gauge may show higher than actual reading when the compressor is running. To get an accurate tire pressure, the compressor needs to be turned off.

! CAUTION

If the inflation pressure is not maintained, drive the vehicle a second time, refer to Distributing the sealant. Then repeat steps 1 to 4.

Use of the TMK may be ineffectual for tire damage larger than approximately 4 mm (0.16 in).

We recommend that you contact an authorized retailer of Genesis Branded products if the tire cannot be made roadworthy with the Tire Mobility Kit.

! WARNING

The tire inflation pressure must be inflated to the proper pressure (Refer to “Tire and Wheels” section in chapter 2). If it is not, do not continue driving.

Call for road side service or towing.

! CAUTION

Tire pressure sensor

The sealant on the tire pressure sensor and wheel should be removed when you replace the tire with a new one and inspect the tire pressure sensors. We recommend that you get this done at an authorized retailer of Genesis Branded products.

i Information

When reinstalling the repaired or replaced tire and wheel on the vehicle, tighten the wheel bolt to 14~16 kg·m (101~116 lbf·ft).

TOWING

Towing service

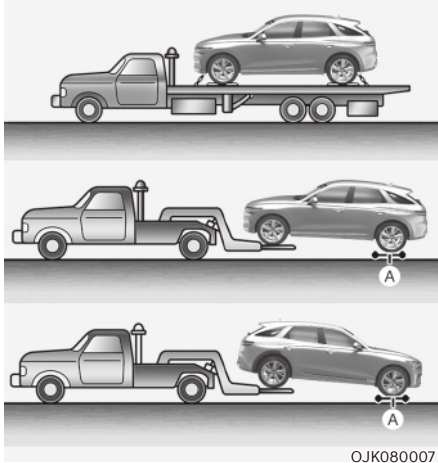

[A] : Dollies

If emergency towing is necessary, we recommend having it done by an authorized retailer of Genesis Branded products or a commercial tow-truck service.

Proper lifting and towing procedures are necessary to prevent damage to the vehicle. The use of wheel dollies or flatbed is recommended.

For 2WD vehicles, it is acceptable to tow the vehicle with the front wheels on the ground (without dollies) and the rear wheels off the ground.

If any of the loaded wheels or suspension components are damaged or the vehicle is being towed with the rear wheels on the ground, use a towing dolly under the rear wheels.

When being towed by a commercial tow truck and wheel dollies are not used, the rear of the vehicle should always be lifted, not the front.

For AWD vehicles, it must be towed with a wheel lift and dollies or flatbed equipment with all the wheels off the ground.

NOTICE

- **Do not lift the vehicle by the tow fitting or body and chassis parts. Otherwise the vehicle may be damaged.**
- **An AWD vehicle should never be towed with the wheels on the ground. This can cause serious damage to the transmission or the AWD system.**



CAUTION

- **Do not tow the vehicle with the rear wheels on the ground as this may cause damage to the vehicle.**

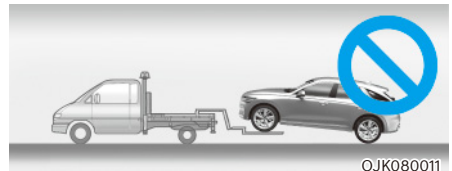

OJK080011

- **Do not tow with sling-type equipment. Use wheel lift or flatbed equipment.**



OJK080010

When towing your vehicle in an emergency without wheel dollies:

1. Release EPB before turning off the engine.
2. Press the Engine Start/Stop button to the OFF position.
3. Change the gear to N (Neutral) by pressing the P release button (need to remove cap-cover) while pressing the brake pedal. **For more details, refer to “Automatic Transmission” section in chapter 6.**
4. Press the Engine Start/Stop button to the ACC position.



CAUTION

Failure to shift the gear to N (Neutral) may cause internal damage to the transmission.

Removable towing hook

1. Open the tailgate, and remove the towing hook from the tool case.
2. Remove the hole cover.

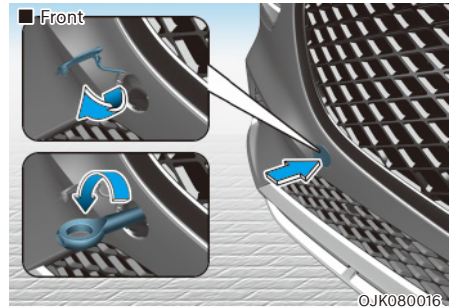

- Push the lower part of the bumper hole cover.

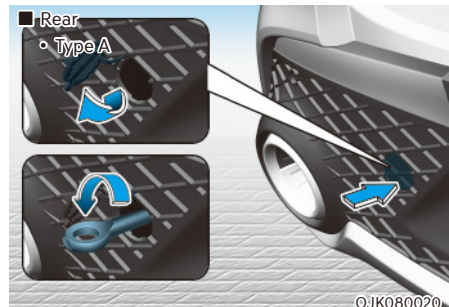

- Push the left part of the bumper hole cover.

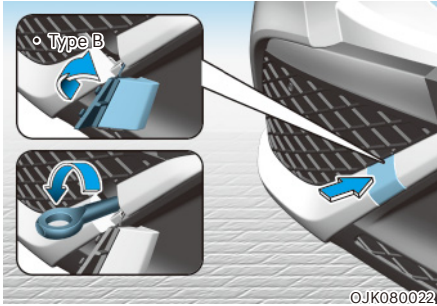

- Pull the lower part of the bumper hole cover.
3. Install the towing hook by turning it clockwise into the hole until it is fully secured.
 4. Remove the towing hook and install the cover after use.

NOTICE

Failure to properly tighten the towing hook may result in vehicle damage and deformation of related parts.



CAUTION

Make sure the towing hook is tightened properly. If not, during towing the towing hook may be thrown off the vehicle resulting in serious injury or accident.

Emergency towing

■ Front

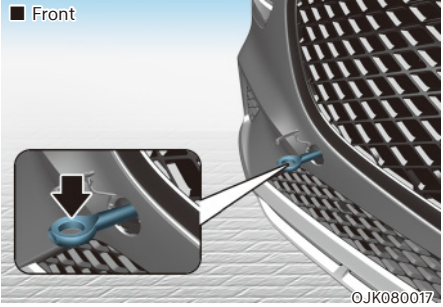

■ Rear

- Type A

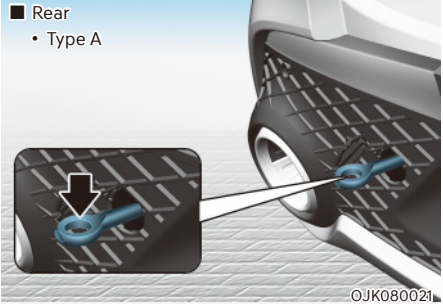

- Type B

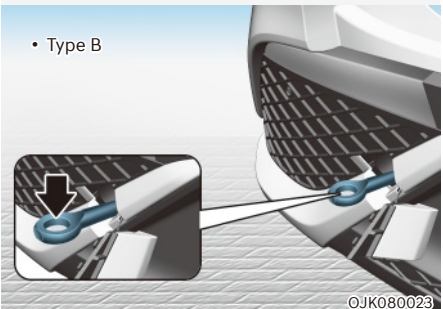

If towing is necessary, we recommend you have it done by an authorized retailer of Genesis Branded products or a commercial tow truck service.

If a towing service is not available in an emergency, your vehicle may be temporarily towed using a cable or chain secured to the emergency towing hook at the front (or rear) of the vehicle.

Use extreme caution when towing the vehicle with a cable or chain. A driver must be in the vehicle to steer it and operate the brakes.

Towing in this manner may be done only on hard-surfaced roads for a short distance and at low speeds. Also, the wheels, axles, power train, steering and brakes must all be in good working condition.



CAUTION

The driver must be in the vehicle for steering and braking operations when the vehicle is being towed. Passengers other than the driver must not be in the vehicle.

Always follow these emergency towing precautions:

- Press the Engine Start/Stop button to the ACC position so the steering wheel is not locked.
- Shift the gear to N (Neutral).
- Release the parking brake.
- Depress the brake pedal with more force than normal as you will have reduced braking performance.
- More steering effort will be required because the power steering system will be disabled.
- Use a vehicle heavier than your own to tow your vehicle.
- The drivers of both vehicles should communicate with each other frequently.
- Before emergency towing, check that the hook is not broken or damaged.
- Fasten the towing cable or chain securely to the hook.
- Do not jerk the hook. Apply steady and even force.

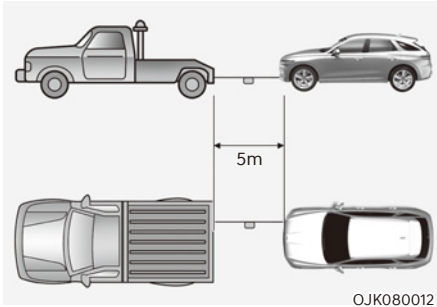

- Use a towing cable or chain less than 5 m (16 feet) long. Attach a white or red cloth (about 30 cm (12 inches) wide) in the middle of the cable or chain for easy visibility.
- Drive carefully so the towing cable or chain remains tight during towing.
- Before towing, check the automatic transmission for fluid leaks under your vehicle. If the automatic transmission fluid is leaking, flatbed equipment or a towing dolly must be used.

NOTICE

Accelerate or decelerate the vehicle in a slow and gradual manner while maintaining tension on the tow rope or chain to start or drive the vehicle, otherwise tow hooks and the vehicle may be damaged.

NOTICE

To avoid damage to your vehicle and vehicle components when towing:

- Always pull straight ahead when using the towing hooks. Do not pull from the side or at a vertical angle.
- Do not use the towing hooks to pull a vehicle out of mud, sand or other conditions from which the vehicle cannot be driven out under its own power.
- Limit the vehicle speed to 15 km/h (10 mph) and drive less than 1.5 km (1 mile) when towing to avoid serious damage to the automatic transmission.

EMERGENCY COMMODITY (IF EQUIPPED)

Your vehicle is equipped with emergency commodities to help you respond to emergency situation.

Fire extinguisher

If there is small fire and you know how to use the fire extinguisher, follow these steps carefully.

1. Pull out the safety pin at the top of the extinguisher that keeps the handle from being accidentally pressed.
2. Aim the nozzle towards the base of the fire.
3. Stand approximately 2.5 m (8 ft) away from the fire and squeeze the handle to discharge the extinguisher. If you release the handle, the discharge will stop.
4. Sweep the nozzle back and forth at the base of the fire. After the fire appears to be out, watch carefully since it may re-ignite.

First aid kit

Supplies for use in giving first aid such as scissors, bandage and adhesive tape, etc. are provided.

Triangle reflector

Place the triangle reflector on the road to warn oncoming vehicles during emergencies, such as when the vehicle is parked by the roadside due to problems.

Tire pressure gauge (if equipped)

Tires normally lose some air in day-to-day use, and you may have to add air periodically and usually it is not a sign of a leaking tire, but of normal wear. Always check tire pressure when the tires are cold because tire pressure increases with temperature.

To check the tire pressure, take the following steps:

1. Unscrew the inflation valve cap that is located on the rim of the tire.
2. Press and hold the gauge against the tire valve. Some air will leak as you begin and more will leak if you don't press the gauge in firmly.
3. A firm non-leaking push will activate the gauge.
4. Read the tire pressure on the gauge to see whether the tire pressure is low or high.
5. Adjust the tire pressure to the specified pressure. Refer to "Tires and Wheels" section in chapter 2.
6. Reinstall the inflation valve cap.

PAN-EUROPEAN ECALL SYSTEM (FOR EUROPE, IF EQUIPPED)

The vehicle is equipped with a device* connected with the Pan-European eCall system for making emergency call to response teams. The Pan-European eCall system is an automatic emergency call service made in event of a traffic accident or other** accidents on the roads of Europe. (only in countries with regulation on this system)

The system allows contacting with an officer of the single duty dispatch service in case of accidents on the roads of Europe. (only in countries with regulation on this system)

The Pan-European eCall system given conditions, stated in the Owner's Manual as well as Warranty and Service book transmits data to the Public Safety Answering Point (PSAP) including such information as vehicle location, vehicle type, VIN (vehicle identification number of the vehicle).

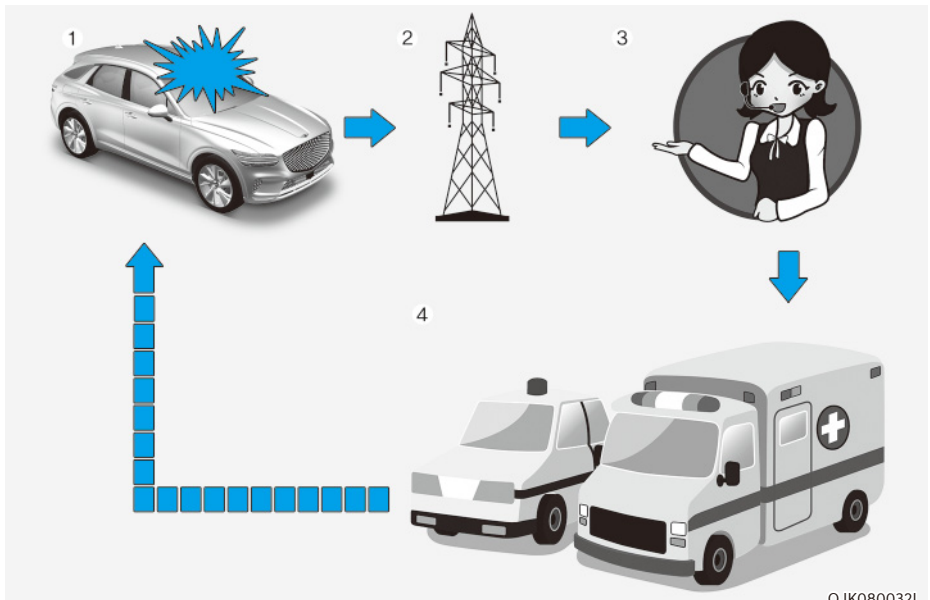

OJK080032L

1. Road accident
2. Wireless network
3. Public Safety Answering Point (PSAP)
4. Rescue

* Pan-European eCall device in the Owner's Manual means equipment, installed in the vehicle, which provides connection with the Pan-European eCall system.

** "Other accidents" mean any accidents on the roads of Europe (only in countries with regulation on this system) resulted in injured people and/or necessity of provision of assistance. In case of registration of any accident, it is necessary to stop a vehicle, press button SOS (location of the button is specified on the picture in the chapter "Pan-European eCall (IF EQUIPPED)") of the Owner's Manual. When making a call, the system gathers information about the vehicle (from which a call was made), after which connects the car with an officer of the Public Safety Answering Point (PSAP) to tell about the reason of the emergency call.

Once the data which is stored in the Pan-European eCall system is delivered to the rescue center to assist the driver and passengers with proper rescue operations, the data will be deleted after rescue operation is completed.

Description of the ecall in-vehicle system (FOR EUROPE)

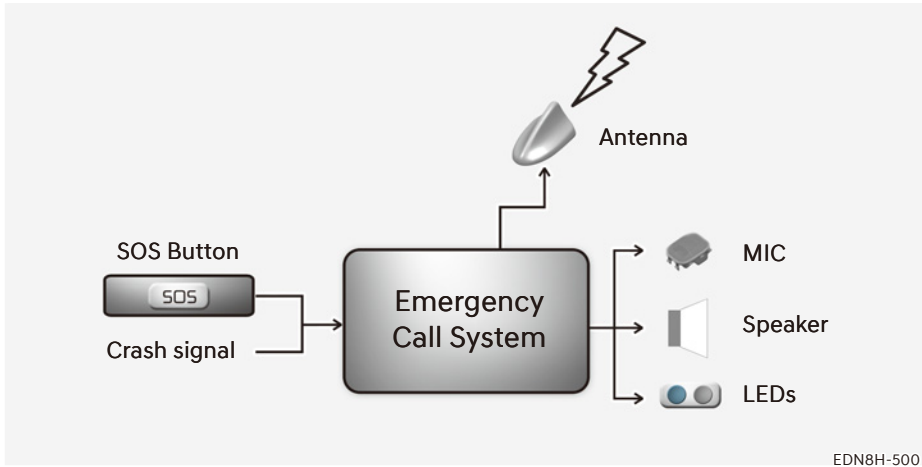

Overview of the 112-based eCall in-vehicle system, its operation and functionalities: refer to this section. The 112-based eCall service is a public service of general interest and is accessible free of charge.

The 112-based eCall in-vehicle system is activated by default. It is activated automatically by means of invehicle sensors in the event of a severe accident.

It will also be triggered automatically when the vehicle is equipped with a TPS system which does not function in the event of a severe accident.

The 112-based eCall in-vehicle system can also be triggered manually, if needed. Instructions for manual activation of the system: refer to this section.

In the event of a critical system failure that would disable the 112-based eCall in-vehicle system, the following warning will be given to the occupants of the vehicle: refer to this section.

Information on data processing (FOR EUROPE)

Any processing of personal data through the 112-based eCall in-vehicle system shall comply with the personal data protection rules provided for in Directives 95/46/EC (1) and 2002/58/EC (2) of the European Parliament and of the Council, and in particular, shall be based on the necessity to protect the vital interests of the individuals in accordance with Article 7(d) of Directive 95/46/EC (3).

Processing of such data is strictly limited to the purpose of handling the emergency eCall to the single European emergency number 112.

Types of data and its recipients

The 112-based eCall in-vehicle system may collect and process only the following data:

- Vehicle Identification Number
- Vehicle type (passenger vehicle or light commercial vehicle)
- Vehicle propulsion storage type (gasoline/diesel/CNG/LPG/electric/hydrogen)
- Vehicle recent locations and direction of travel
- Log file of the automatic activation of the system and its timestamp
- Any additional data (if applicable): Not applicable

Recipients of data processed by the 112-based eCall in-vehicle system are the relevant public safety answering points designated by the respective public authorities of the country on which territory they are located, to first receive and handle eCalls to the single European emergency number 112. Additional information (if available): Not applicable

- (1) Directive 95/46/EC of the European Parliament and of the Council of 24 October 1995 on the protection of individuals with regard to the processing of personal data and on the free movement of such data (OJ L 281, 23.11.1995, p. 31).
- (2) Directive 2002/58/EC of the European Parliament and of the Council of 12 July 2002 concerning the processing of personal data and the protection of privacy in the electronic communications sector (Directive on privacy and electronic communications) (OJ L 201, 31.7.2002, p. 37).
- (3) Directive 95/46/EC is repealed by Regulation (EU) 2016/679 of the European Parliament and of the Council of 27 April 2016 on the protection of natural persons with regard to the processing of personal data and on the free movement of such data (General Data Protection Regulation) (OJ L 119, 4.5.2016, p. 1). The Regulation applies from 25 May 2018.

Arrangements for data processing

The 112-based eCall in-vehicle system is designed in such a way as to ensure that the data contained in the system memory is not available outside the system before an eCall is triggered. Additional remarks (if any): Not applicable

The 112-based eCall in-vehicle system is designed in such a way as to ensure that it is not traceable and not subject to any constant tracking in its normal operation status. Additional remarks (if any): Not applicable

The 112-based eCall in-vehicle system is designed in such a way as to ensure that data in the system internal memory is automatically and continuously removed.

The vehicle location data is constantly overwritten in the internal memory of the system so as always to keep maximum of the last three up-to-date locations of the vehicle necessary for the normal functioning of the system.

The log of activity data in the 112-based eCall in-vehicle system is kept for no longer than necessary for attaining the purpose of handling the emergency eCall and in any case not beyond 13 hours from the moment an emergency eCall was initiated. Additional remarks (if any): Not applicable

Modalities for exercising data subject's rights

The data subject (the vehicle's owner) has a right of access to data and as appropriate to request the rectification, erasure or blocking of data, concerning him or her, the processing of which does not comply with the provisions of Directive 95/46/EC. Any third parties to whom the data have been disclosed have to be notified of such rectification, erasure or blocking carried out in compliance with this Directive, unless it proves impossible or involves a disproportionate effort.

The data subject has a right to complain to the competent data protection authority if he or she considers that his or her rights have been infringed as a result of the processing of his or her personal data.

Contact service responsible for handling access requests (if any): Not applicable

Pan-European eCall System (FOR EUROPE)

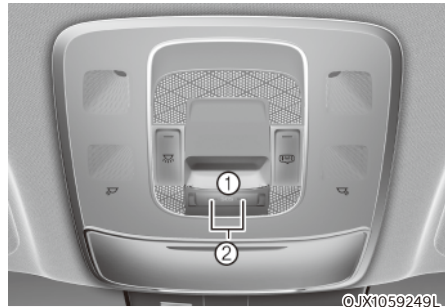

Elements of the Pan-European eCall system, installed in passenger compartment:

- (1) SOS button
- (2) LED

SOS button: the driver/passenger makes an emergency call to the single duty dispatch service by pressing the button.

LED: The LED illuminates for 3 seconds when the Engine Start/Stop button is in the ON position. After that they will switch off at normal operation of the system.

If there are some problems in the system, the SOS indicator light illuminates in the instrument cluster.

Automatic accident reporting (FOR EUROPE)



The Pan-European eCall device automatically makes an emergency call to the Public Safety Answering Point (PSAP) for proper rescuing operations in event of vehicle accident.

For proper emergency services and support the Pan-European eCall system automatically transmits the accident data to the Public Safety Answering Point (PSAP) when a traffic accident is detected.

In this case, the emergency call cannot be hung up by pressing the SOS button and the Pan-European eCall system remains connected until the emergency service officer, receiving the call, disconnects the emergency call.

In minor traffic accidents the Pan-European eCall system may not execute an emergency call. However, an emergency call may be made manually by pressing the SOS button.



CAUTION

Operation of the system is impossible in case of absence of mobile transmission and GPS and Galileo signals.

Manual accident reporting (FOR EUROPE)



The driver or passenger manually can make an emergency call in the Public Safety Answering Point (PSAP), by pressing SOS button to call the necessary emergency services.

A call to the emergency services through the Pan-European eCall system can be cancelled by pressing the SOS button again only before the call connection.

After activation of emergency call in the manual mode (for proper emergency services and support), the Pan-European eCall system automatically transmits the road accident data / or data on other accident to the officer of the Public Safety Answering Point (PSAP) (during emergency call) by pressing the SOS button.

If the driver or passenger accidentally presses the SOS button, it can be canceled by pressing the button again. (For Russia)

It can be canceled by pressing the button again in 3 seconds. It can't be canceled after that. (Except Russia)

In case of road accident or other accident for activation of emergency call in manual mode it is necessary:

1. Stop the vehicle in accordance with traffic rules to ensure safety to yourself and other participants of road traffic;
2. Press the SOS button, when pressing the button SOS registration of the device in the wireless telephonic communication networks is carried out, minimum data set about vehicle and its location is collected in accordance with of the technical requirements of the device. After that connection with the officer of the Pan-European eCall system is made for clearing up reasons (conditions) of the emergency call.
3. After clearing up reasons of the emergency call, the officer of the Public Safety Answering Point (PSAP) sends emergency services and completes the emergency call.

If the emergency call is not carried out in accordance with the procedure, mentioned above, the emergency call will be considered as erroneous.



WARNING

Emergency power supply of the Pan-European eCall system from the battery

- The Pan-European eCall system battery supplies power during 1 hour in case main power source of the vehicle is cut off due to the collision during the emergency situations.
- The Pan-European eCall system battery should be replaced every 3 years. For more information refer to the Maintenance Schedule in chapter 9.

The SOS indicator light in the instrument cluster (system malfunction)

If the SOS indicator light illuminates in normal driving conditions, this can indicate malfunction of the Pan-European eCall system. Please, have the Pan-European eCall system checked at an authorized retailer of Genesis Branded products immediately. Otherwise correct operation of the Pan-European eCall system device, installed in your vehicle is not guaranteed. Owner of the vehicle incurs liability for consequences, occurred as a result of nonobservance of conditions, mentioned above.

Arbitrary Removal or Modification

The Pan-European eCall system calls emergency services for assistance. Thus, any arbitrary removal or changes to the Pan-European eCall system settings may affect your driving safety. Also, it may even make an erroneous emergency call to the Public Safety Answering Point (PSAP). Thereby, we kindly ask you not to make any changes by yourself or by the third parties in the settings of the equipment of the Pan-European eCall system, installed in your vehicle.

UAE ECALL SYSTEM (FOR UAE, IF EQUIPPED)

The vehicle is equipped with a device* connected with the UAE ECALL system for making emergency call to response teams. The UAE ECALL system is an automatic emergency call service made in event of a traffic accident or other** accidents on the roads. (only in countries with regulation on this system)

The system allows contacting with an officer of the single duty dispatch service in case of accidents on the roads. (only in countries with regulation on this system)

The UAE ECALL system given conditions, stated in the Owner's Manual as well as Warranty and Service book transmits data to the Public Safety Answering Point (PSAP) including such information as vehicle location, vehicle type, VIN (vehicle identification number of the vehicle).

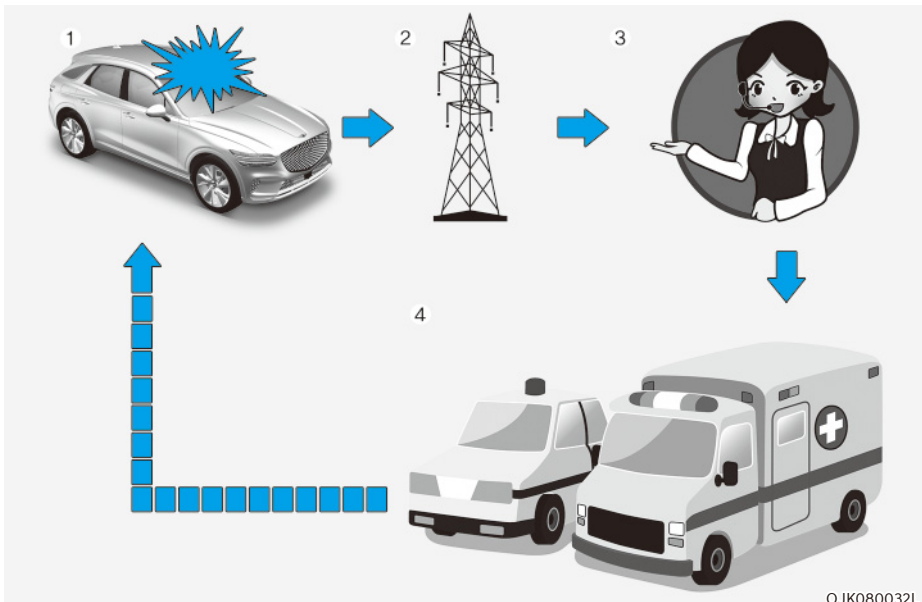

OJK080032L

1. Road accident
2. Wireless network
3. Public Safety Answering Point (PSAP)
4. Rescue

* UAE ECALL device in the Owner's Manual means equipment, installed in the vehicle, which provides connection with the UAE ECALL system.

** "Other accidents" mean any accidents on the roads of UAE (only in countries with regulation on this system) resulted in injured people and/or necessity of provision of assistance. In case of registration of any accident, it is necessary to stop a vehicle, press button SOS (location of the button is specified on the picture in the chapter "UAE ECALL (IF EQUIPPED)") of the Owner's Manual. When making a call, the system gathers information about the vehicle (from which a call was made), after which connects the car with an officer of the Public Safety Answering Point (PSAP) to tell about the reason of the emergency call.

Once the data which is stored in the UAE ECALL system is delivered to the rescue center to assist the driver and passengers with proper rescue operations, the data will be deleted after rescue operation is completed.

Description of the ecall in-vehicle system (FOR UAE)

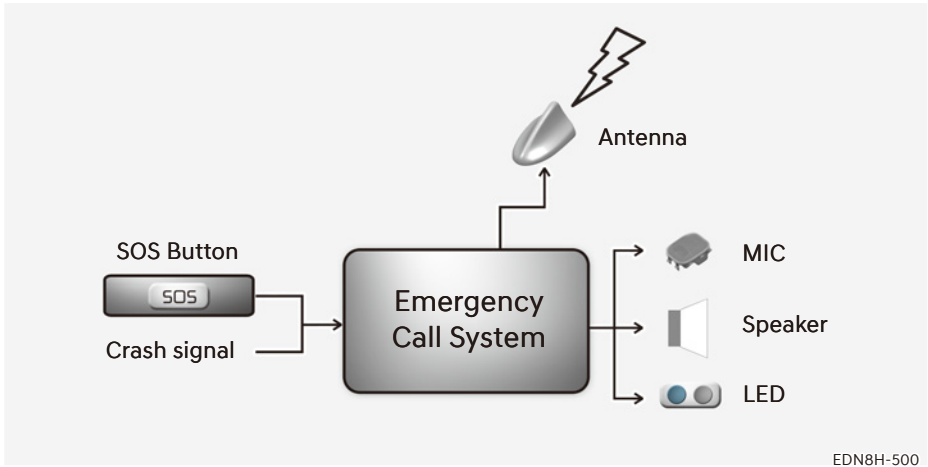

Overview of the 999-based eCall in-vehicle system, its operation and functionalities: refer to this section. The 999-based eCall service is a public service of general interest and is accessible free of charge.

The 999-based eCall in-vehicle system is activated by default. It is activated automatically by means of invehicle sensors in the event of a severe accident.

It will also be triggered automatically when the vehicle is equipped with a TPS system which does not function in the event of a severe accident.

The 999-based eCall in-vehicle system can also be triggered manually, if needed. Instructions for manual activation of the system: refer to this section.

In the event of a critical system failure that would disable the 999-based eCall in-vehicle system, the following warning will be given to the occupants of the vehicle: refer to this section.

Information on data processing (FOR UAE)

Any processing of personal data through the 999-based eCall in-vehicle system shall comply with the personal data protection rules provided for in Directives 95/46/EC (1) and 2002/58/EC (2) of the European Parliament and of the Council, and in particular, shall be based on the necessity to protect the vital interests of the individuals in accordance with Article 7(d) of Directive 95/46/EC (3).

Processing of such data is strictly limited to the purpose of handling the emergency eCall to the single UAE emergency number 999.

Types of data and its recipients

The 999-based eCall in-vehicle system may collect and process only the following data:

- Vehicle Identification Number
- Vehicle type (passenger vehicle or light commercial vehicle)
- Vehicle propulsion storage type (gasoline/diesel/CNG/LPG/electric/hydrogen)
- Vehicle recent locations and direction of travel
- Log file of the automatic activation of the system and its timestamp
- Any additional data (if applicable): Not applicable

Recipients of data processed by the 999-based eCall in-vehicle system are the relevant public safety answering points designated by the respective public authorities of the country on which territory they are located, to first receive and handle eCalls to the single UAE emergency number 999. Additional information (if available): Not applicable

- (1) Directive 95/46/EC of the European Parliament and of the Council of 24 October 1995 on the protection of individuals with regard to the processing of personal data and on the free movement of such data (OJ L 281, 23.11.1995, p. 31).
- (2) Directive 2002/58/EC of the European Parliament and of the Council of 12 July 2002 concerning the processing of personal data and the protection of privacy in the electronic communications sector (Directive on privacy and electronic communications) (OJ L 201, 31.7.2002, p. 37).
- (3) Directive 95/46/EC is repealed by Regulation (EU) 2016/679 of the European Parliament and of the Council of 27 April 2016 on the protection of natural persons with regard to the processing of personal data and on the free movement of such data (General Data Protection Regulation) (OJ L 119, 4.5.2016, p. 1). The Regulation applies from 25 May 2018.

Arrangements for data processing

The 999-based eCall in-vehicle system is designed in such a way as to ensure that the data contained in the system memory is not available outside the system before an eCall is triggered. Additional remarks (if any): Not applicable

The 999-based eCall in-vehicle system is designed in such a way as to ensure that it is not traceable and not subject to any constant tracking in its normal operation status. Additional remarks (if any): Not applicable

The 999-based eCall in-vehicle system is designed in such a way as to ensure that data in the system internal memory is automatically and continuously removed.

The vehicle location data is constantly overwritten in the internal memory of the system so as always to keep maximum of the last three up-to-date locations of the vehicle necessary for the normal functioning of the system.

The log of activity data in the 999-based eCall in-vehicle system is kept for no longer than necessary for attaining the purpose of handling the emergency eCall and in any case not beyond 13 hours from the moment an emergency eCall was initiated. Additional remarks (if any): Not applicable

Modalities for exercising data subject's rights

The data subject (the vehicle's owner) has a right of access to data and as appropriate to request the rectification, erasure or blocking of data, concerning him or her, the processing of which does not comply with the provisions of Directive 95/46/EC. Any third parties to whom the data have been disclosed have to be notified of such rectification, erasure or blocking carried out in compliance with this Directive, unless it proves impossible or involves a disproportionate effort.

The data subject has a right to complain to the competent data protection authority if he or she considers that his or her rights have been infringed as a result of the processing of his or her personal data.

Contact service responsible for handling access requests (if any): Not applicable

UAE ECALL System (FOR UAE)

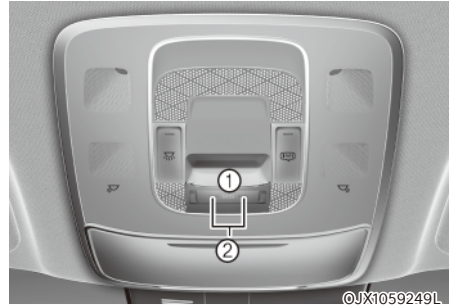

Elements of the UAE ECALL system, installed in passenger compartment:

- (1) SOS button
- (2) LED

SOS button: the driver/passenger makes an emergency call to the single duty dispatch service by pressing the button.

LED: The LED illuminates for 3 seconds when the Engine Start/Stop button is in the ON position. After that they will switch off at normal operation of the system.

If there are some problems in the system, the SOS indicator light illuminates in the instrument cluster.

Automatic accident reporting (FOR UAE)



The UAE eCALL device automatically makes an emergency call to the Public Safety Answering Point (PSAP) for proper rescuing operations in event of vehicle accident. For proper emergency services and support the UAE eCALL system automatically transmits the accident data to the Public Safety Answering Point (PSAP) when a traffic accident is detected.

In this case, the emergency call cannot be hung up by pressing the SOS button and the UAE eCALL system remains connected until the emergency service officer, receiving the call, disconnects the emergency call.

In minor traffic accidents the UAE eCALL system may not execute an emergency call. However, an emergency call may be made manually by pressing the SOS button.



CAUTION

Operation of the system is impossible in case of absence of mobile transmission and GPS and Galileo signals.

Manual accident reporting (FOR UAE)



OJX108904L

The driver or passenger manually can make an emergency call in the Public Safety Answering Point (PSAP), by pressing SOS button to call the necessary emergency services.

A call to the emergency services through the UAE eCALL system can be cancelled by pressing the SOS button again only before the call connection.

After activation of emergency call in the manual mode (for proper emergency services and support), the UAE eCALL system automatically transmits the road accident data / or data on other accident to the officer of the Public Safety Answering Point (PSAP) (during emergency call) by pressing the SOS button.

If the driver or passenger accidentally presses the SOS button, it can be canceled by pressing the button again. (For Russia)

It can be canceled by pressing the button again in 3 seconds. It can't be canceled after that. (Except Russia)

In case of road accident or other accident for activation of emergency call in manual mode it is necessary:

1. Stop the vehicle in accordance with traffic rules to ensure safety to yourself and other participants of road traffic;
2. Press the SOS button, when pressing the button SOS registration of the device in the wireless telephonic communication networks is carried out, minimum data set about vehicle and its location is collected in accordance with of the technical requirements of the device. After that connection with the officer of the UAE eCALL system is made for clearing up reasons (conditions) of the emergency call.
3. After clearing up reasons of the emergency call, the officer of the Public Safety Answering Point (PSAP) sends emergency services and completes the emergency call.

If the emergency call is not carried out in accordance with the procedure, mentioned above, the emergency call will be considered as erroneous.



WARNING

Emergency power supply of the UAE eCALL system from the battery

- The UAE eCALL system battery supplies power during 1 hour in case main power source of the vehicle is cut off due to the collision during the emergency situations.
- The UAE eCALL system battery should be replaced every 3 years. For more information refer to the Maintenance Schedule in chapter 9.

The SOS indicator light in the instrument cluster (system malfunction)

If the SOS indicator light illuminates in normal driving conditions, this can indicate malfunction of the UAE eCALL system. Please, have the UAE eCALL system checked at an authorized retailer of Genesis Branded products immediately. Otherwise correct operation of the UAE eCALL system device, installed in your vehicle is not guaranteed. Owner of the vehicle incurs liability for consequences, occurred as a result of nonobservance of conditions, mentioned above.

Arbitrary Removal or Modification

The UAE eCALL system calls emergency services for assistance. Thus, any arbitrary removal or changes to the UAE eCALL system settings may affect your driving safety. Also, it may even make an erroneous emergency call to the Public Safety Answering Point (PSAP). Thereby, we kindly ask you not to make any changes by yourself or by the third parties in the settings of the equipment of the UAE eCALL system, installed in your vehicle.

9. Maintenance

Engine compartment.....	9-4
Maintenance services.....	9-6
Owner's responsibility	9-6
Owner maintenance precautions.....	9-6
Owner maintenance	9-7
Owner maintenance schedule	9-8
Scheduled maintenance services.....	9-9
Normal maintenance schedule (except Europe).....	9-10
Maintenance under severe usage conditions (except Europe).....	9-16
Normal maintenance schedule (for Europe).....	9-18
Maintenance under severe usage conditions (for Europe)	9-23
Explanation of scheduled maintenance items	9-25
Engine oil	9-28
Checking the engine oil level	9-28
Checking the engine oil and filter	9-31
Engine coolant/Liquid-cooled intercooler coolant	9-32
Checking the coolant level	9-32
Changing coolant.....	9-34
Brake fluid	9-35
Checking the brake fluid level.....	9-35
Washer fluid	9-36
Checking the washer fluid level	9-36
Fuel filter (for diesel engine)	9-36
Draining water from fuel filter	9-36
Fuel filter cartridge replacement	9-36
Air cleaner	9-37
Filter replacement.....	9-37
Cabin air filter.....	9-38
Filter inspection.....	9-38
Filter replacement.....	9-38
Wiper blades	9-39
Blade inspection.....	9-39
Blade replacement.....	9-39

Battery	9-41
For best battery service	9-42
Battery capacity label	9-43
Battery recharging	9-43
Reset items	9-44
Tires and wheels	9-45
Tire care	9-45
Recommended cold tire inflation pressures	9-45
Check tire inflation pressure	9-46
Tire rotation	9-47
Wheel alignment and tire balance	9-48
Tire replacement	9-48
Wheel replacement.....	9-49
Tire traction	9-49
Tire maintenance	9-49
Tire sidewall labeling.....	9-50
Low aspect ratio tires.....	9-53
Fuses.....	9-54
Instrument panel fuse replacement	9-55
Engine compartment panel fuse replacement	9-56
Fuse/relay panel description.....	9-57
Light bulbs.....	9-74
Headlamp, position lamp, turn signal lamp, Daytime Running Light (DRL) replacement	9-76
Headlamp aiming.....	9-76
Puddle lamp replacement	9-79
Rear combination lamp replacement	9-79
Rear fog lamp replacement.....	9-79
High mounted stop lamp replacement	9-80
License plate lamp replacement.....	9-80
Interior light replacement.....	9-80

9. Maintenance

Appearance care.....	9-82
Exterior care	9-82
Interior care	9-87
Emission control system.....	9-90
Gasoline Particulate Filter (GPF)	9-92
Diesel Particulate Filter (DPF).....	9-92
Lean NOx Trap (for diesel engine).....	9-93
Selective Catalytic Reduction (SCR) (for diesel engine).....	9-93

ENGINE COMPARTMENT

■ 2.5 T-GDI

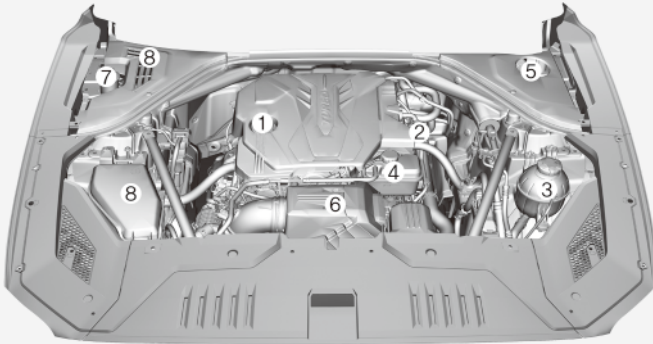

■ 3.5 T-GDI

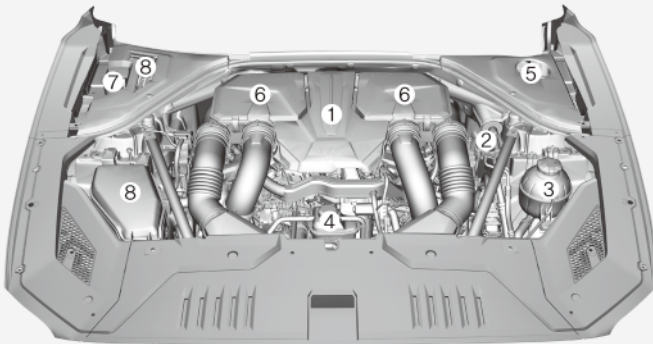

The actual engine compartment in the vehicle may differ from the illustration.

OJK091001N/OJK090002L

- | | |
|---|--------------------------------------|
| 1. Engine oil filler cap (3.5 T-GDI's filler cap is under the engine cover) | 5. Brake fluid reservoir |
| 2. Engine oil dipstick | 6. Air cleaner |
| 3. Engine coolant reservoir | 7. Windshield washer fluid reservoir |
| 4. Liquid-cooled intercooler coolant reservoir | 8. Fuse box |

■ 2.2 TCI

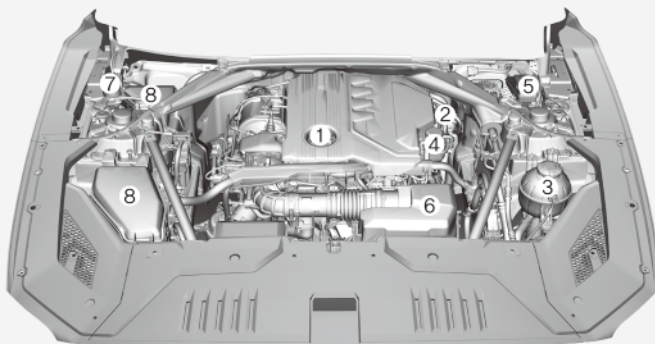

The actual shape may differ from the illustration.

OJK090003L

- | | |
|--|--------------------------------------|
| 1. Engine oil filler cap | 5. Brake fluid reservoir |
| 2. Engine oil dipstick | 6. Air cleaner |
| 3. Engine coolant reservoir | 7. Windshield washer fluid reservoir |
| 4. Liquid-cooled intercooler coolant reservoir | 8. Fuse box |

MAINTENANCE SERVICES

You should exercise the utmost care to prevent damage to your vehicle and injury to yourself whenever performing any maintenance or inspection procedures.

We recommend you have your vehicle maintained and repaired by an authorized retailer of Genesis Branded products. An authorized retailer of Genesis Branded products meets Genesis Branded Vehicle's high service quality standards and receives technical support from Genesis Branded Vehicle in order to provide you with a high level of service satisfaction.

Owner's responsibility

Maintenance service and record retention are the owner's responsibility.

You should retain documents that show proper maintenance has been performed on your vehicle in accordance with the scheduled maintenance service charts shown on the following pages. You need this information to establish your compliance with the servicing and maintenance requirements of your vehicle warranties.

Detailed warranty information is provided in your Service Passport.

Repairs and adjustments required as a result of improper maintenance or a lack of required maintenance are not covered.

Owner maintenance precautions

Inadequate, incomplete or insufficient servicing may result in operational problems with your vehicle that could lead to vehicle damage, an accident, or personal injury. This chapter provides instructions only for the maintenance items that are easy to perform.

Your vehicle should not be modified in any way. Such modifications may adversely affect the performance, safety or durability of your vehicle and may, in addition, violate conditions of the limited warranties covering the vehicle.

NOTICE

Improper owner maintenance during the warranty period may affect warranty coverage. For details, read the separate Service Passport provided with the vehicle. If you're unsure about any service or maintenance procedure, have it done by an authorized retailer of Genesis Branded products.

OWNER MAINTENANCE



WARNING

Performing maintenance work on a vehicle can be dangerous. If you lack sufficient knowledge and experience or the proper tools and equipment to do the work, we recommend that it is done by an authorized retailer of Genesis Branded products. **ALWAYS** follow these precautions for performing maintenance work:

- Park your vehicle on level ground. Shift the vehicle to P (Park), apply the parking brake, and press the Engine Start/Stop button to the OFF position.
- Block the tires (front and back) to prevent the vehicle from moving. Remove loose clothing or jewelry that can become entangled in moving parts.
- If you must run the engine during maintenance, do so out doors or in an area with plenty of ventilation.
- Keep flames, sparks, or smoking materials away from the battery and fuel-related parts.



WARNING

Touching metal parts



Do not touch metal parts (including strut bars) while the engine is operating or hot. Doing so could result in serious personal injury. Turn the engine off and wait until the metal parts cool down to perform maintenance work on the vehicle.

The following lists are vehicle checks and inspections that should be performed by the owner or an authorized retailer of Genesis Branded products at the frequencies indicated to help ensure safe, dependable operation of your vehicle.

Any adverse conditions should be brought to the attention of your dealer as soon as possible.

These Owner Maintenance vehicle checks are generally not covered by warranties and you may be charged for labor, parts and lubricants used.



WARNING

Diesel Engine

Never manipulate or modify the injection system while running the diesel engine or within 30 seconds after turning OFF the diesel engine. The high-pressure pump, high-pressure pipes, rail, and injectors are still subject to high pressure immediately after stopping the diesel engine.

When the fuel leakage vents out, it may cause serious body injury. Any people, who are implanted with the artificial cardiac pacemaker, should remain away from the ECU or the wiring harness by at least 30 cm (12 inches), while running the diesel engine. The high currents of the electronic engine control system produce a considerable amount of magnetic fields.

Owner maintenance schedule

When you stop for fuel:

- Check the coolant level in the engine coolant reservoir or the liquid-cooled intercooler coolant reservoir.
- Check the windshield washer fluid level.
- Check for low or under-inflated tires.



WARNING

Be careful when checking your coolant level when the engine is hot. This may result in coolant being blown out of the opening and cause serious burns and other injuries.

While operating your vehicle:

- Note any changes in the sound of the exhaust or any smell of exhaust fumes in the vehicle.
- Check for vibrations in the steering wheel. Notice if there is any increased steering effort or looseness in the steering wheel, or change in its straight-ahead position.
- Notice if your vehicle constantly turns slightly or “pulls” to one side when traveling on smooth, level road.
- When stopping, listen and check for unusual sounds, pulling to one side, increased brake pedal travel or “hard-to-push” brake pedal.
- If any slipping or changes in the operation of your transmission occurs, check the transmission fluid level.
- Check the automatic transmission P (Park) function.
- Check the parking brake.
- Check for fluid leaks under your vehicle (water dripping from the air conditioning system during or after use is normal).

At least monthly:

- Check coolant level in the engine coolant reservoir.
- Check the operation of all exterior lights, including the stoplights, turn signals and hazard warning flashers.
- Check the inflation pressures of all tires including the spare for tires that are worn, show uneven wear, or are damaged.
- Check for loose wheel lug nuts.

At least twice a year: (for example, every Spring and Autumn)

- Check radiator, heater and air conditioning hoses for leaks or damage.
- Check windshield washer spray and wiper operation. Clean wiper blades with a clean cloth dampened with washer fluid.
- Check headlamp alignment.
- Check muffler, exhaust pipes, shields and clamps.
- Check the seat belts for wear and function.

At least once a year:

- Clean body and door drain holes.
- Lubricate door hinges and hood hinges.
- Lubricate door and hood locks and latches.
- Lubricate door rubber weather strips.
- Check the air conditioning system.
- Inspect and lubricate automatic transmission linkage and controls.
- Clean the battery and terminals.
- Check the brake fluid level.

SCHEDULED MAINTENANCE SERVICES

Follow Normal Maintenance Schedule if the vehicle is usually operated where none of the following conditions apply. If any of the following conditions apply, you must follow the Maintenance Under Severe Usage Conditions.

- Repeated driving short distance of less than 8 km (5 miles) in normal temperature or less than 16 km (10miles) in freezing temperature
- Extensive engine idling or low speed driving for long distances
- Driving on rough, dusty, muddy, unpaved, graveled or salt-spread roads
- Driving in areas using salt or other corrosive materials or in very cold weather
- Driving in heavy dust conditions
- Driving in heavy traffic area
- Driving on uphill, downhill, or mountain road repeatedly
- Using for towing or camping, and driving with loads on the roof
- Driving as a patrol car, taxi, other commercial use of vehicle towing
- Frequently driving under high speed or rapid acceleration/deceleration
- Frequently driving in stop-and-go condition
- Engine oil usage which is not recommended (Mineral type, Semi-synthetic, Lower grade spec, etc.)

If your vehicle is operated under the above conditions, you should inspect, replace or refill more frequently than the following Normal Maintenance Schedule. After the periods or distance shown in the chart, continue to follow the prescribed maintenance intervals.



Information

- **As it is normal for engine oil to be consumed during driving, the engine oil level should be checked on regular basis.**
- **The engine oil change interval for normal operating conditions is based on the use of the recommended engine specification. If the recommended engine oil specification is not used, then replace the engine oil according to the maintenance schedule under severe operating conditions.**
- **The vehicle may be equipped with the Engine Oil Change Interval Alert that predicts engine oil life based on the driver's driving history and alerts the driver to change engine oil.**
 - **If the deterioration of the engine oil increases depending on the driver's driving severity, the remaining oil life alert appears on the instrument cluster before the normal engine oil replacement interval. We recommend that the engine oil and filter be changed by an authorized retailer of Genesis Branded products.**
 - **Engine Oil Change Interval Alert works when the recommended engine oil is used. So, if recommended engine oil is not used, replace the engine oil according to the maintenance schedule under severe usage conditions.**
Also, check the amount of engine oil regularly as this system assumes that the engine oil is being filled normally.
 - **Always reset the remaining engine oil life whenever the engine oil is changed. Otherwise, the Engine Oil Change Interval Alert will not be correct.**
If there is no alert until the maximum maintenance interval, we recommend that vehicle be checked by an authorized retailer of Genesis Branded products.

Normal maintenance schedule (except Europe)

Gasoline engine items

MAINTENANCE INTERVALS	Number of months or driving distance, whichever comes first										
	Months	12	24	36	48	60	72	84	96		
MAINTENANCE ITEM	Miles*1,000	10	20	30	40	50	60	70	80		
	Km*1,000	15	30	45	60	75	90	105	120		
Engine oil and engine oil filter *1 *2 *3		Replace every 15,000 km (10,000 miles) or 12 months									
Drive belts *4											
Fuel additives *5		Add every 15,000 km (9,000 miles) or 12 months									
Intercooler, in/out hose, air intake hose		At first, inspect at 8,000 km (5,000 miles) or 6 months After that, inspect every 32,000 km (20,000 miles) or 24 months									

* Middle East includes Livia, Iran, Morocco, Sudan, Tunisia and Egypt

I : Inspect and if necessary, adjust, correct, clean or replace.

R : Replace or change.

*1: The engine oil level should be checked regularly and maintained properly. Operating with an insufficient amount of oil can damage the engine, and such damage is not covered by warranty.

*2: Check the engine oil level and leak every 500 km (350 miles) or before starting a long trip.

*3-1: All 2.5 T-GDI and 3.5 T-GDI except the Middle East requires <API SN PLUS (or above) Full synthetic> grade engine oil. If a lower grade engine oil (mineral oil including Semi-synthetic) is used, then the engine oil and engine oil filter must be replaced according to the maintenance schedule under severe usage conditions.

*3-2: 3.5 T-GDI for the Middle East requires <ACEA A5/B5 Full synthetic> grade engine oil. If a lower grade engine oil (mineral oil including Semi-synthetic) is used, then the engine oil and engine oil filter must be replaced according to the maintenance schedule under severe usage conditions.

*4: Inspect drive belt tensioner, idler and alternator pulley and if necessary correct or replace.

*5: If good quality gasolines meet Europe Fuel standards (EN228) or equivalents including fuel additives is not available, one bottle of additive is recommended. Additives are available from your an authorized retailer of Genesis Branded products along with information on how to use them. Do not mix other additives.

Normal maintenance schedule (except Europe) Gasoline engine items

MAINTENANCE INTERVALS	Number of months or driving distance, whichever comes first									
	Months	12	24	36	48	60	72	84	96	
MAINTENANCE ITEM	Miles*1,000	10	20	30	40	50	60	70	80	
	Km*1,000	15	30	45	60	75	90	105	120	
Air cleaner filter	Except Middle East	I	I	R	I	I	R	I	I	
	For Middle East	R	R	R	R	R	R	R	R	
Spark plugs *6		Replace every 75,000 km (50,000 miles)								
Vapor hose and fuel filler cap					I				I	
Fuel tank air filter			I		R		I		R	
Fuel lines, hoses and connections					I				I	
Fuel filter	For China, Brazil		I		R		I		R	

I : Inspect and if necessary, adjust, correct, clean or replace.

R : Replace or change.

*6: For your convenience, it can be replaced prior to it's interval when you do maintenance of other items.

* Fuel filter is considered to be maintenance free but the quality of fuel used may impact the frequency of maintenance needed. If there are some important safety matters like fuel flow restriction, surging, loss of power, hard starting problem, etc. replace the fuel filter immediately regardless of maintenance schedule and consult an authorized retailer of Genesis Branded products for details.

Normal maintenance schedule (except Europe)
Diesel engine items

MAINTENANCE INTERVALS	Number of months or driving distance, whichever comes first										
	Months	12	24	36	48	60	72	84	96		
MAINTENANCE ITEM	Miles×1,000	10	20	30	40	50	60	70	80		
	Km×1,000	15	30	45	60	75	90	105	120		
Engine oil and engine oil filter *1*2	Except Russia	Replace every 10,000 km (6,000 miles) or 12 months									
	For Russia	Replace every 15,000 km (10,000 miles) or 12 months									
Drive belts *3		At first, inspect at 80,000 km (50,000 miles) or 48 months, after that, every 20,000 km (12,500 miles) or 12 months									
Timing belt system (Timing belt, Water pump, Tensioner, Idler)	2.2 TCI	Inspect Timing belt every 120,000 km (80,000 miles) Replace Timing belt system (Timing belt, Water pump, Tensioner, Idler) every 240,000 km (160,000 miles)									
Air cleaner filter	Except Middle East	I	I	R	I	I	R	I	I		
	For Middle East	R	R	R	R	R	R	R	R		
Fuel lines, hoses and connections		I	I	I	I	I	I	I	I		

I : Inspect and if necessary, adjust, correct, clean or replace.

R : Replace or change.

*1: The engine oil level should be checked regularly and maintained properly. Operating with an insufficient amount of oil can damage the engine, and such damage is not covered by warranty.

*2: Check the engine oil level and leak every 500 km (350 miles) or before starting a long trip.

*3: Inspect drive belt tensioner, idler and alternator pulley and if necessary correct or replace.

Normal maintenance schedule (except Europe) Diesel engine items

MAINTENANCE INTERVALS	Number of months or driving distance, whichever comes first												
	Months	12	24	36	48	60	72	84	96				
MAINTENANCE ITEM	Miles*1,000	10	20	30	40	50	60	70	80	90	105	120	
	Km*1,000	15	30	45	60	75	90	105	120				
Fuel filter cartridge *4	Except EN590 (Consult your dealer)												
	For EN590		I										
Fuel filler cap													

I : Inspect and if necessary, adjust, correct, clean or replace.

R : Replace or change.

*4: This maintenance schedule depends on fuel quality. It is applicable only when using a qualified fuel <"EN590 or equivalent">. If the diesel fuel specifications don't meet the EN590, it must be replaced more frequently. Genesis Branded Vehicle recommends "every 7,500 km (4,500 miles) inspection, every 15,000 km (10,000 miles) replacement": If there are some important safety matters like fuel flow restriction, surging, loss of power, hard starting problem etc., replace the fuel filter immediately regardless of maintenance schedule. We recommend that you consult an authorized retailer of Genesis Branded products for details.

**Normal maintenance schedule (except Europe)
General items - for both Gasoline and Diesel engine**

MAINTENANCE ITEM	MAINTENANCE INTERVALS									
	Months	12	24	36	48	60	72	84	96	Number of months or driving distance, whichever comes first
	Miles×1,000	10	20	30	40	50	60	70	80	
	Km×1,000	15	30	45	60	75	90	105	120	
Cooling system		Inspect coolant level for leak every day At first, inspect 60,000 km (40,000 miles) or 48 months after that, inspect every 30,000 km (20,000 miles) or 24 months								
Engine coolant *1		At first, replace at 200,000 km (120,000 miles) or 120 months ; after that, replace every 40,000 km (25,000 miles) or 24 months								
All electrical systems		I	I	I	I	I	I	I	I	I
Battery condition	Except Middle East	I	I	I	I	I	I	I	I	I
	For Middle East									
		Inspect every 10,000 km (6,000 miles) or 6 months								
Pan-European eCall system battery (if equipped) / ERA-GLONASS system battery (if equipped) / UAE eCall system battery (if equipped)		Replace every 3 years								
Brake lines, hoses and connections		I	I	I	I	I	I	I	I	I
Brake pedal			I		I		I		I	I
Parking brake			I		I		I		I	I
Brake fluid		I	I	R	I	I	I	R	I	I

I : Inspect and if necessary, adjust, correct, clean or replace.
R : Replace or change.

*1: When adding coolant, use only deionized water or soft water for your vehicle and never mix hard water in the coolant filled at the factory. An improper coolant mixture can result in serious malfunction or engine damage. For your convenience, it can be replaced prior to it's interval when you do maintenance of other items.

Normal maintenance schedule (except Europe) General items - for both Gasoline and Diesel engine

MAINTENANCE INTERVALS	Number of months or driving distance, whichever comes first											
	Months	12	24	36	48	60	72	84	96			
MAINTENANCE ITEM	Miles*1,000	10	20	30	40	50	60	70	80			
	Km*1,000	15	30	45	60	75	90	105	120			
Disc brakes and pads		I	I	I	I	I	I	I	I			
Steering gear rack, linkage and boots		I	I	I	I	I	I	I	I			
Driveshaft and boots		I	I	I	I	I	I	I	I			
Tire (pressure & tread wear)		I	I	I	I	I	I	I	I			
Suspension ball joints		Inspect every 10,000 km (6,000 miles)										
Air conditioner refrigerant		I	I	I	I	I	I	I	I			
Air conditioner compressor		I	I	I	I	I	I	I	I			
Cabin air filter		R	R	R	R	R	R	R	R			
Automatic transmission fluid	For Middle East		I	I	I	I	I	I	I			
	Except Middle East		No check, No service required									
Exhaust system		I	I	I	I	I	I	I	I			
Front differential oil (AWD) / Rear differential oil *2					I				I			
Transfer case oil (AWD)		No check, No service required										
Electronic Limited Slip Differential (e-LSD) oil		No check, No service required										
Propeller shaft		I	I	I	I	I	I	I	I			

I : Inspect and if necessary, adjust, correct, clean or replace.

R : Replace or change.

*2: Front/Rear differential oil should be changed anytime they have been submerged in water.

Maintenance under severe usage conditions (except Europe)

The following items must be serviced more frequently on cars mainly used under severe driving conditions. Refer to the chart below for the appropriate maintenance intervals.

R : Replace

I : Inspect and if necessary, adjust, correct, clean or replace

Maintenance item		Maintenance operation	Maintenance intervals	Driving condition	
Engine oil and engine oil filter	Gasoline engine	R	Replace every 8,000 km (5,000 miles) or 6 months	H, I, J, L	
	Diesel engine	Except Russia	R		Replace every 5,000 km (3,000 miles) or 6 months
		For Russia	R		Replace every 7,500 km (5,000 miles) or 6 months
Air cleaner filter		R	Replace more frequently depending on the condition	C, E	
Spark plugs		R	Replace more frequently depending on the condition	A, B, F, G, H, I, K	
Steering gear rack, linkage and boots		I	Inspect more frequently depending on the condition	C, D, E, F, G	
Suspension ball joints		I	Inspect more frequently depending on the condition	C, D, E, F, G	
Disc brakes and pads, calipers and rotors		I	Inspect more frequently depending on the condition	C, D, E, G, H	

Maintenance item	Maintenance operation	Maintenance intervals	Driving condition
Parking brake	I	Inspect more frequently depending on the condition	C, D, G, H
Driveshaft and boots	I	Inspect more frequently depending on the condition	C, D, E, F, G, H, I, J
Cabin air filter	R	Replace more frequently depending on the condition	C, E, G
Automatic transmission fluid	R	Replace every 100,000 km (65,000 miles)	A, C, F, G, H, I, K
Front differential oil (AWD) / Rear differential oil	R	Replace every 120,000 km (80,000 miles)	C, D, E, G, H, I, J
Transfer case oil (AWD)	-	No check, No service required	-
Electronic Limited Slip Differential (e-LSD) oil	-	No check, No service required	-
Propeller shaft	I	Inspect more frequently depending on the condition	C, D, E, F, G, H, I, J

Severe driving conditions

- A. Repeatedly driving short distance of less than 8 km (5 miles) in normal temperature or less than 16 km (10 miles) in freezing temperature
- B. Extensive engine idling or low speed driving for long distances
- C. Driving on rough, dusty, muddy, unpaved, graveled or salt-spread roads
- D. Driving in areas using salt or other corrosive materials or in very cold weather
- E. Driving in heavy dust conditions
- F. Driving in heavy traffic area
- G. Driving on uphill, downhill, or mountain road repeatedly
- H. Using for towing or camping, and driving with loads on the roof
- I. Driving for patrol car, taxi, other commercial car or vehicle towing
- J. Frequently driving under high speed or rapid acceleration/deceleration
- K. Frequently driving in stop-and-go conditions
- L. Engine oil usage which is not recommended (Mineral type, Semi-synthetic, Lower grade spec, etc.)

Normal maintenance schedule (for Europe) Gasoline engine items

MAINTENANCE INTERVALS	Number of months or driving distance, whichever comes first											
	Months	24	48	72	96	120	144	168	192			
MAINTENANCE ITEM	Miles×1,000	20	40	60	80	100	120	140	160			
	Km×1,000	30	60	90	120	150	180	210	240			
Engine oil and engine oil filter *1 *2 *3		Replace every 15,000 km (9,000 miles) or 12 months										
Drive belts *4		At first, inspect at 90,000 km (60,000 miles) or 72 months, after that, every 30,000 km (20,000 miles) or 24 months										
Fuel additives *5		Add every 15,000 km (9,000 miles) or 12 months										
Intercooler, in/out hose, air intake hose		At first, inspect at 8,000 km (5,000 miles) or 6 months										
Air cleaner filter		I	R	I	R	I	R	I	R	I	R	

I : Inspect and if necessary, adjust, correct, clean or replace.

R : Replace or change.

*1: The engine oil level should be checked regularly and maintained properly. Operating with an insufficient amount of oil can damage the engine, and such damage is not covered by warranty.

*2: Check the engine oil level and leak every 500 km (350 miles) or before starting a long trip.

*3: Requires <API SN PLUS (or above) Full synthetic> grade engine oil. If a lower grade engine oil (mineral oil including Semi-synthetic) is used, then the engine oil and engine oil filter must be replaced as indicated severe maintenance condition.

*4: Inspect drive belt tensioner, idler and alternator pulley and if necessary correct or replace.

*5: If good quality gasolines meet Europe Fuel standards (EN228) or equivalents including fuel additives is not available, one bottle of additive is recommended. Additives are available from your authorized retailer of Genesis Branded products along with information on how to use them. Do not mix other additives.

Normal maintenance schedule (for Europe) Gasoline engine items

MAINTENANCE INTERVALS	Number of months or driving distance, whichever comes first											
	Months	24	48	72	96	120	144	168	192			
MAINTENANCE ITEM	Miles*1,000	20	40	60	80	100	120	140	160	180	210	240
	Km*1,000	30	60	90	120	150	180	210	240			
Spark plugs *6												
Vapor hose and fuel filler cap												
Fuel tank air filter												
Fuel lines, hoses and connections												

Replace every 80,000 km (53,000 miles)

I : Inspect and if necessary, adjust, correct, clean or replace.
R : Replace or change.

*6: For your convenience, it can be replaced prior to it's interval when you do maintenance of other items.

Normal maintenance schedule (for Europe)

Diesel engine items

MAINTENANCE INTERVALS	Number of months or driving distance, whichever comes first										
	Months	24	48	72	96	120	144	168	192		
MAINTENANCE ITEM	Miles×1,000	20	40	60	80	100	120	140	160		
	Km×1,000	30	60	90	120	150	180	210	240		
Engine oil and engine oil filter *1 *2 *3 *4		R	R	R	R	R	R	R	R	R	
Drive belts *5		At first, inspect at 90,000 km (60,000 miles) or 48 months, after that, every 30,000 km (20,000 miles) or 24 months									
Timing belt system (Timing belt, Water pump, Tensioner, Idler)	2, 2 TCI	Inspect Timing belt every 120,000 km (80,000 miles)									
		Replace Timing belt system (Timing belt, Water pump, Tensioner, Idler) every 240,000 km (160,000 miles)									
Air cleaner filter		Inspect every 15,000 km (10,000 miles) or 12 months after that, replace every 60,000 km (40,000 miles) or 48 months									
Fuel lines, hoses and connections		I	I	I	I	I	I	I	I	I	
Fuel filter cartridge *6		I	R	I	R	I	R	I	R	R	
Fuel filler cap		I	I	I	I	I	I	I	I	I	

I : Inspect and if necessary, adjust, correct, clean or replace.

R : Replace or change.

*1: The engine oil level should be checked regularly and maintained properly. Operating with an insufficient amount of oil can damage the engine, and such damage is not covered by warranty.

*2: Check the engine oil level and leak every 500 km (350 miles) or before starting a long trip.

*3: This maintenance schedule depends on fuel quality. It is applicable only when using a qualified fuel <"EN590 or equivalent">. If the diesel fuel specifications don't meet the EN590, it must be replaced according to the severe maintenance schedule.

*4: If SAE OW-20 engine oil is not available, replace engine oil and engine oil filter every 15,000 km (10,000 miles) or 12 months.

*5: Inspect drive belt tensioner, idler and alternator pulley and if necessary correct or replace.

*6: This maintenance schedule depends on fuel quality. It is applicable only when using a qualified fuel <"EN590 or equivalent">. If the diesel fuel specifications don't meet the EN590, it must be replaced more frequently. If there are some important safety matters like fuel flow restriction, surging, loss of power, hard starting problem etc., replace the fuel filter immediately regardless of maintenance schedule. We recommend that you consult an authorized retailer of Genesis Branded products for details.

Normal maintenance schedule (for Europe) General items - for both Gasoline and Diesel engine

MAINTENANCE INTERVALS MAINTENANCE ITEM	Number of months or driving distance, whichever comes first											
	Months	24	48	72	96	120	144	168	192	210	240	
	Miles*1,000	20	40	60	80	100	120	140	160	180	240	
	Km*1,000	30	60	90	120	150	180	210	240	240	240	
Cooling system		Inspect "Coolant level adjustment and leak" every day. At first, inspect 60,000 km (40,000 miles) or 48 months after that, inspect every 30,000 km (20,000 miles) or 24 months										
Engine coolant *1		At first, replace at 210,000 km (120,000 miles) or 10 years : after that, replace every 30,000 km (20,000 miles) or 24 months *2										
All electrical systems		I	I	I	I	I	I	I	I	I	I	
Battery condition		I	I	I	I	I	I	I	I	I	I	
Pan-European eCall system battery (if equipped) / ERA-GLONASS system battery (if equipped) / UAE eCall system battery (if equipped)		Replace every 3 years										
Brake lines, hoses and connections		I	I	I	I	I	I	I	I	I	I	
Parking brake		I	I	I	I	I	I	I	I	I	I	
Brake fluid		R	R	R	R	R	R	R	R	R	R	
Disc brakes and pads		I	I	I	I	I	I	I	I	I	I	

I : Inspect and if necessary, adjust, correct, clean or replace.

R : Replace or change.

*1: When adding coolant, use only deionized water or soft water for your vehicle and never mix hard water in the coolant filled at the factory. An improper coolant mixture can result in serious malfunction or engine damage.

*2: For your convenience, it can be replaced prior to it's interval when you do maintenance of other items.

Normal maintenance schedule (for Europe)
General items - for both Gasoline and Diesel engine

MAINTENANCE INTERVALS	Number of months or driving distance, whichever comes first												
	Months	24	48	72	96	120	144	168	192				
MAINTENANCE ITEM	Miles*1,000	20	40	60	80	100	120	140	160				
	Km*1,000	30	60	90	120	150	180	210	240				
Steering gear rack, linkage and boots		I	I	I	I	I	I	I	I	I	I	I	I
Driveshaft and boots		I	I	I	I	I	I	I	I	I	I	I	I
Tire (pressure & tread wear)		I	I	I	I	I	I	I	I	I	I	I	I
Suspension ball joints		I	I	I	I	I	I	I	I	I	I	I	I
Air conditioner refrigerant		I	I	I	I	I	I	I	I	I	I	I	I
Air conditioner compressor		I	I	I	I	I	I	I	I	I	I	I	I
Cabin air filter		R	R	R	R	R	R	R	R	R	R	R	R
Automatic transmission fluid		No check, No service required											
Exhaust system		I	I	I	I	I	I	I	I	I	I	I	I
Front differential oil (AWD) / Rear differential oil*3		I	I	I	I	I	I	I	I	I	I	I	I
Transfer case oil (AWD)		No check, No service required											
Electronic Limited Slip Differential (e-LSD) oil		No check, No service required											
Propeller shaft		I	I	I	I	I	I	I	I	I	I	I	I

I : Inspect and if necessary, adjust, correct, clean or replace.

R : Replace or change.

*3: Front/Rear differential oil should be changed anytime they have been submerged in water.

Maintenance under severe usage conditions (for Europe)

The following items must be serviced more frequently on cars mainly used under severe and low mileage driving conditions. Refer to the chart below for the appropriate maintenance intervals.

R : Replace

I : Inspect and if necessary, adjust, correct, clean or replace

Maintenance item		Maintenance operation	Maintenance Intervals	Driving condition
Engine oil and engine oil filter	Gasoline engine	R	Replace every 8,000 km (5,500 miles) or 6 months	A, B, C, D, E, F, G, H, I, J, K, L
	Diesel engine	R	Replace every 15,000 km (10,000 miles) or 12 months	I, J, K, L
Air cleaner filter		R	Replace more frequently depending on the condition	C, E
Spark plugs		R	Replace more frequently depending on the condition	A, B, F, H, I, K
Steering gear rack, linkage and boots		I	Inspect more frequently depending on the condition	C, D, E, F, G
Suspension ball joints		I	Inspect more frequently depending on the condition	C, D, E, F, G
Disc brakes and pads, calipers and rotors		I	Inspect more frequently depending on the condition	C, D, E, G, H
Parking brake		I	Inspect more frequently depending on the condition	C, D, G, H
Driveshaft and boots		I	Inspect more frequently depending on the condition	C, D, E, F, G, H, I, J

Maintenance item	Maintenance operation	Maintenance Intervals	Driving condition
Cabin air filter	R	Replace more frequently depending on the condition	C, E, G
Automatic transmission fluid	R	Replace every 90,000 km (60,000 miles)	A, C, F, G, H, I, K
Front differential oil (AWD) / Rear differential oil	R	Replace every 120,000 km (80,000 miles)	C, D, E, G, H, I, J
Transfer case oil (AWD)	-	No check, No service required	-
Electronic Limited Slip Differential (e-LSD) oil	-	No check, No service required	-
Propeller shaft	I	Inspect more frequently depending on the condition	C, D, E, F, G, H, I, J

Severe driving conditions

- A. Repeatedly driving short distance of less than 8 km (5 miles) in normal temperature or less than 16 km (10 miles) in freezing temperature
- B. Extensive engine idling or low speed driving for long distances
- C. Driving on rough, dusty, muddy, unpaved, graveled or salt-spread roads
- D. Driving in areas using salt or other corrosive materials or in very cold weather
- E. Driving in the heavy dust condition
- F. Driving in heavy traffic area
- G. Driving on uphill, downhill, or mountain roads repeatedly
- H. Using for towing or camping, and driving with loads on the roof
- I. Driving as patrol car, taxi, other commercial car or vehicle towing
- J. Frequently driving under high speed or rapid acceleration/deceleration
- K. Frequently driving in stop-and-go conditions
- L. Engine oil usage which is not recommended (Mineral type, Semi-synthetic, Lower grade spec, etc.)

EXPLANATION OF SCHEDULED MAINTENANCE ITEMS

Engine oil and filter

The engine oil and filter should be changed at the intervals specified in the maintenance schedule. If the vehicle is being driven in severe conditions, more frequent oil and filter changes are required.

Drive belts

Inspect all drive belts for evidence of cuts, cracks, excessive wear or oil saturation and replace if necessary.

Drive belts should be checked periodically for proper tension and adjusted as necessary.



Information

When you are inspecting the belt, turn the engine off.

Fuel lines, fuel hoses and connections

Check the fuel lines, fuel hoses and connections for leakage and damage. We recommend an authorized retailer of Genesis Branded products replace any damaged or leaking parts immediately.

Fuel filter (for gasoline engine)

The fuel filter is considered to be maintenance free but periodic inspection is recommended for this maintenance depends on fuel quality. If there are some important matters like fuel flow restriction, surging, loss of power, hard starting problem etc., replace the fuel filter immediately. We recommend that you consult an authorized retailer of Genesis Branded products for details.

Fuel filter (cartridge) (for diesel engine)

A clogged filter can limit the speed at which the vehicle may be driven, damage the emission system and cause multiple issues such as hard starting. If an excessive amount of foreign matter accumulates in the fuel tank, the filter may require replacement more frequently. After installing a new filter, run the engine for several minutes, and check for leaks at the connections. We recommend that the fuel filter be installed by an authorized retailer of Genesis Branded products.

Vacuum crankcase ventilation hoses (if equipped)

Inspect the surface of the hoses for evidence of heat and/or mechanical damage. Hard and brittle rubber, cracking, tears, cuts, abrasions, and excessive swelling indicate deterioration. Particular attention should be paid to examine those hose surfaces nearest to high heat sources, such as the exhaust manifold.

Inspect the hose routing to ensure that the hoses do not come in contact with any heat source, sharp edges or moving component which might cause heat damage or mechanical wear. Inspect all hose connections, such as clamps and couplings, to make sure they are secure, and that no leaks are present. Hoses should be replaced immediately if there is any evidence of deterioration or damage.

Vapor hose and fuel filler cap

The vapor hose and fuel filler cap should be inspected at those intervals specified in the maintenance schedule. Make sure a new vapor hose or fuel filler cap is correctly replaced.

Air cleaner filter

We recommend that the air cleaner filter be replaced by an authorized retailer of Genesis Branded products.

Spark plugs (for gasoline engine)

Make sure to install new spark plugs of the correct heat range.

Cooling system

Check cooling system components, such as radiator, coolant reservoir, hoses and connections for leakage and damage. Replace any damaged parts.

Engine coolant/Liquid-cooled intercooler coolant

The coolant should be changed at the intervals specified in the maintenance schedule.

Automatic transmission fluid

Automatic transmission fluid should not be checked under normal usage conditions.

We recommend that the automatic transmission fluid be changed by an authorized retailer of Genesis Branded products according to the maintenance schedule.

Information

Automatic transmission fluid color is red when new.

As the vehicle is driven, the automatic transmission fluid will begin to look darker.

This is a normal condition. It does not need to be replaced based on the color change.

NOTICE

The use of a non-specified fluid could result in transmission malfunction and failure.

Use only specified automatic transmission fluid. (Refer to “Recommended Lubricants and Capacities” section in chapter 2.)

Brake hoses and lines

Visually check for proper installation, chafing, cracks, deterioration and any leakage. Replace any deteriorated or damaged parts immediately.

Brake fluid

Check the brake fluid level in the brake fluid reservoir. The level should be between the MIN and the MAX marks on the side of the reservoir. Use only hydraulic brake fluid conforming to DOT 4 specification.

Brake discs, pads, calipers and rotors

Check the pads, the disc, and the rotor for any excessive wear-out. Inspect calipers for any fluid leakage.

For more information on checking the pads or lining wear limit, refer to the Genesis Branded Vehicle web site.

(<http://service.hyundai-motor.com>)

Exhaust pipe and muffler

Visually inspect the exhaust pipes, muffler and hangers for cracks, deterioration, or damage. Start the engine and listen carefully for any exhaust gas leakage. Tighten connections or replace parts as necessary.

Propeller shaft

Check the propeller shaft, boots, clamps, rubber couplings and center-bearing rubber for cracks, deterioration, or damage. Replace any damaged parts and if necessary, repack the grease.

Suspension mounting bolts

Check the suspension connections for looseness or damage. Retighten to the specified torque.

Steering gear box, linkage & boots/lower arm ball joint

With the vehicle stopped and the engine off, check for excessive free-play in the steering wheel. Check the linkage for bends or damage. Check the dust boots and ball joints for deterioration, cracks, or damage.

Replace any damaged parts.

Drive shafts and boots

Check the drive shafts, boots and clamps for cracks, deterioration, or damage.

Replace any damaged parts and, if necessary, repack the grease.

Air conditioning refrigerant

Check the air conditioning lines and connections for leakage and damage.

ENGINE OIL

Checking the engine oil level

Engine oil is used for lubricating, cooling, and operating various hydraulic components in the engine. Engine oil consumption while driving is normal, and it is necessary to check and refill the engine oil regularly. Also, check and refill the oil level within the recommended maintenance schedule to prevent deterioration of oil performance.

Check the engine oil following the below procedure.

Gasoline engine

1. Follow all of the oil manufacturer's precautions.
2. Be sure the vehicle is on the level ground in P (Park) with the parking brake set and the wheels blocked.
3. Turn the engine on and warm the engine up until the coolant temperature reaches a constant normal temperature.
4. Turn the engine off, remove the oil filler cap and pull the dipstick out. Wait for 15 minutes for the oil to return to the oil pan.
5. Wipe the dipstick clean and re-insert it fully.

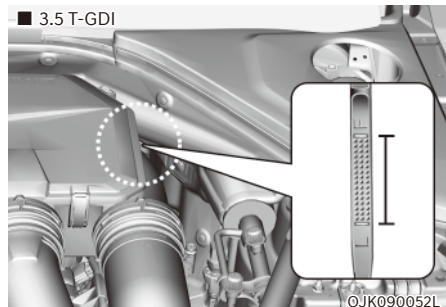
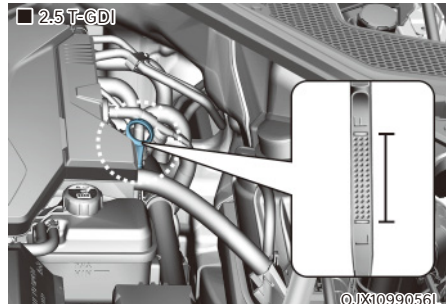

6. Pull the dipstick out again and check the level. The level should be between F (Full) and L (Low).

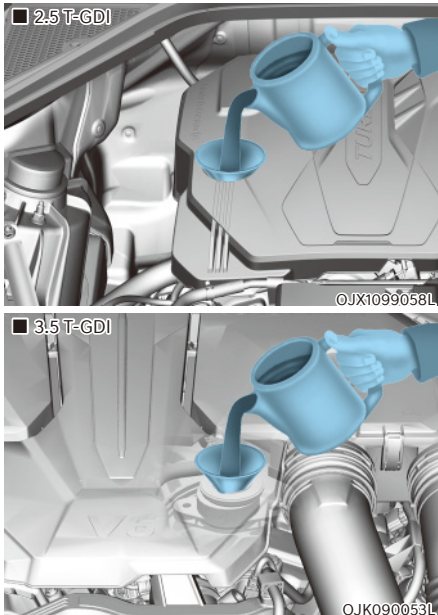

7. If the oil level is below L, add enough oil to bring the level to F.

Use only the specified engine oil (Refer to “Recommended Lubricants and Capacities” section in chapter 2).

NOTICE

To prevent damage to your engine:

- Do not spill engine oil when adding or changing engine oil. Wipe off spilled oil immediately.
- The engine oil consumption may increase while you break in a new vehicle and it will be stabilized after driving 6,000 km (4,000 miles).
- The engine oil consumption can be affected by driving habits, climate conditions, traffic conditions, oil quality, etc. Therefore, it is recommended that you inspect the engine oil level regularly and refill it if necessary.

Diesel engine

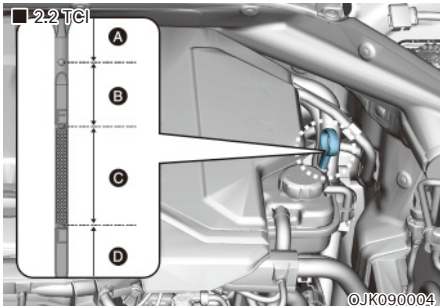

Range	Required action
A	Recommended to contact an authorized retailer of Genesis Branded products.
B	Do not refill engine oil.
C	You may add engine oil as long as the oil level does not go above the C range.
D	You must add oil and make sure that the oil level is in the C Range.

1. Follow all of the oil manufacturer's precautions.
2. Be sure the vehicle is on the level ground in P (Park) with the parking brake set and the wheels blocked.
3. Turn the engine on and allow the engine to reach normal operating temperature.
4. Turn the engine off, remove the oil filler cap and pull the dipstick out. Wait for 15 minutes for the oil to return to the oil pan.
5. Wipe the dipstick clean and re-insert it fully.
6. Pull out the dipstick out again and check the level. The level should be in the C range.

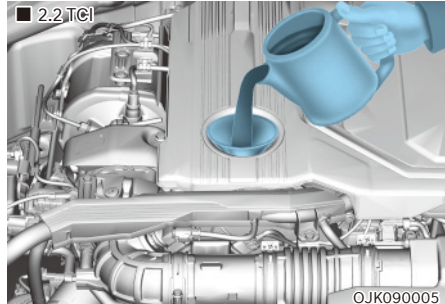

If the level is in the D range, add enough engine oil to bring the level up to the C range.

Use only the specified engine oil (Refer to “Recommended Lubricants and Capacities” section in chapter 2).

NOTICE

To prevent damage to your engine:

- **Do not spill engine oil when adding or changing engine oil. Wipe off spilled oil immediately.**
- **The engine oil consumption may increase while you break in a new vehicle and it will be stabilized after driving 6,000 km (4,000 miles).**
- **The engine oil consumption can be affected by driving habits, climate conditions, traffic conditions, oil quality, etc. Therefore, it is recommended that you inspect the engine oil level regularly and refill it if necessary.**

Checking the engine oil and filter

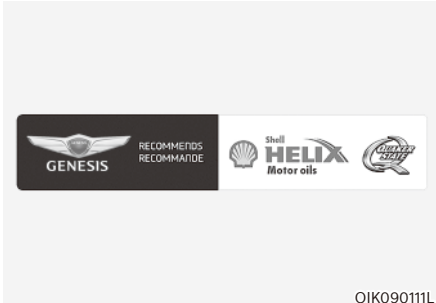

- The lubrication, rust prevention, cooling, and cleaning effect of the engine oil will gradually degrade during its use. We recommend that the engine oil and filter be changed by an authorized retailer of Genesis Branded products according to the Engine Oil Change Interval Alert function or the Maintenance Schedule at the beginning of this chapter.
- If the maintenance schedule to replace engine oil is exceeded, the engine oil performance may deteriorate and the engine condition may be affected. Therefore, replace the engine oil according to the maintenance schedule.
- To keep the engine in optimal condition, use the recommended engine oil. If the recommended engine oil and filter are not used, replace it according to the maintenance schedule under severe usage conditions.
- The purpose of the maintenance schedule for engine oil replacement is to prevent oil deterioration and it is irrelevant to oil consumption. Check and refill engine oil regularly.

i Information

When the oil pressure is low due to insufficient engine oil, the Engine Oil Pressure (油圧) warning light will illuminate. In addition, the enhanced engine protection system, which limits the engine's power is activated and the Malfunction Indicator Lamp (故障灯) will illuminate when the vehicle is driven in this state continuously. When oil pressure is restored, the Engine Oil Pressure warning light will turn off and the engine power will no longer be limited. However, for gasoline 2.5 turbo engine, when the oil pressure is restored, the warning light and the enhanced engine protection system will turn off after the engine is restarted.

⚠ CAUTION

The engine oil is very hot immediately after the vehicle has been driven and can cause burns during replacement. Replace the engine oil after the engine oil has cooled down.

⚠ WARNING

Used engine oil may cause irritation or cancer of the skin if left in contact with the skin for prolonged periods of time. Used engine oil contains chemicals that have caused cancer in laboratory animals. Always protect your skin by washing your hands thoroughly with soap and warm water as soon as possible after handling used oil.

ENGINE COOLANT/LIQUID-COOLED INTERCOOLER COOLANT

The high-pressure cooling system has a reservoir filled with year-round antifreeze coolant. The reservoir is filled at the factory.

Check the antifreeze protection and coolant level at least once a year, at the beginning of the winter season and before traveling to a colder climate.

Checking the coolant level

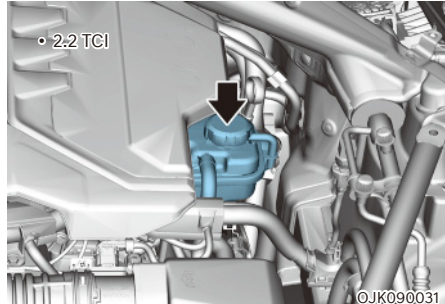
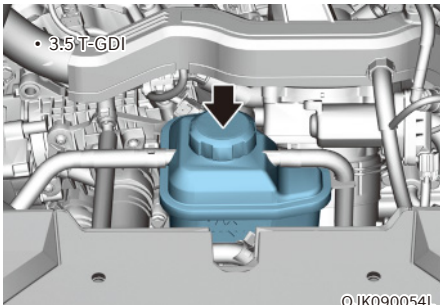
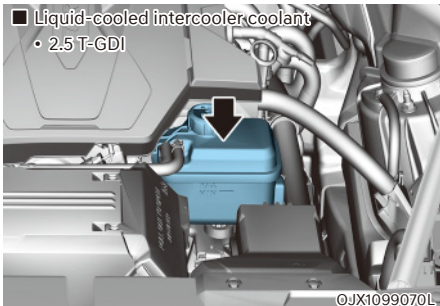
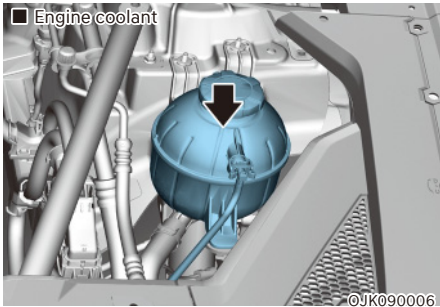

Check the condition and connections of all cooling system hoses and heater hoses. Replace any swollen or deteriorated hoses.

The coolant level should be filled between the MAX and the MIN marks on the side of the coolant reservoir when the engine is cool.

If the coolant level is low, add enough distilled (deionized) water to bring the level to the MAX mark, but do not overfill. If frequent additions are required, we recommend that you see an authorized retailer of Genesis Branded products for a cooling system inspection.

WARNING



Never remove the engine coolant cap and/or liquid-cooled intercooler coolant cap or the drain plug while the engine and radiator are hot. Hot coolant and steam may blow out under pressure, causing serious injury.

Turn the vehicle off and wait until the engine cools down. Use extreme care when removing the engine coolant cap and/or liquid-cooled intercooler coolant cap. Wrap a thick towel around it, and turn it counterclockwise slowly. Step back while the pressure is released from the cooling system. When you are sure all the pressure has been released, using a thick towel, and continue turning counterclockwise to remove it.

i Information

The coolant level is influenced by the engine temperature. Before checking or refilling the coolant, turn the engine off.

! WARNING



The electric motor for the cooling fan may continue to operate or start up when the engine is not running and can cause serious injury. Keep hands, clothing and tools away from the rotating fan blades of the cooling fan.

Always turn off the vehicle unless the vehicle has to be inspected with the engine on. Be cautious as the cooling fan may operate if the negative (-) battery terminal is not disconnected.

! WARNING

Make sure the coolant cap is properly closed after refilling coolant. Otherwise the engine could be overheated while driving.

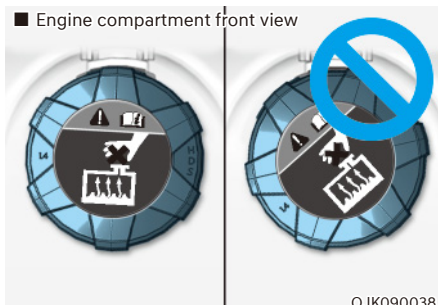

1. Check if the coolant cap label is straight in front.

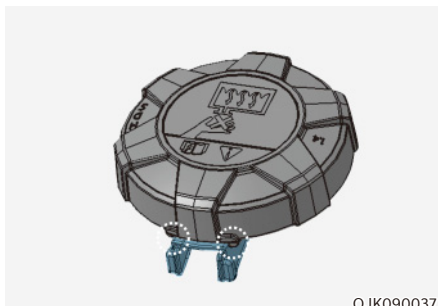

2. Make sure that the tiny protrusions inside the coolant cap is securely interlocked.

Recommended coolant

- When adding coolant, use only deionized water, distilled water or soft water for your vehicle and never mix hard water in the coolant filled at the factory.
- An incorrect coolant mixture can result in severe malfunction or engine damage.
- The engine in your vehicle has aluminum engine parts and must be protected by an phosphate-based ethylene glycol coolant to prevent corrosion and freezing.
- Do not use alcohol or methanol coolant or mix them with the specified coolant.
- Do not use a solution that contains more than 60% antifreeze or less than 35% antifreeze, which would reduce the effectiveness of the solution.

For mixing percentage, refer to the following table:

Ambient Temperature	Mixture Percentage (volume)	
	Antifreeze	Water
-15°C (5°F)	35	65
-25°C (-31°F)	40	60
-35°C (31°F)	50	50
-45°C (-49°F)	60	40

Information

If in doubt about the mix ratio, a 50% water and 50% antifreeze mix is the easiest to mix together as it will be the same quantity of each. It is suitable to use for most temperature ranges of -35°C (-31°F) and higher.

Changing coolant

We recommend that coolant be changed by an authorized retailer of Genesis Branded products according to the Maintenance Schedule at the beginning of this chapter.

WARNING

Do not use engine coolant or antifreeze in the washer fluid reservoir.

Engine coolant can severely obscure visibility when sprayed on the windshield and may cause loss of vehicle control resulting in an accident.

Engine coolant may also cause damage to paint and body trim.

NOTICE

To prevent damage to engine parts, put a thick towel around the engine coolant cap or liquid-cooled intercooler coolant cap before refilling the coolant to prevent the coolant from overflowing into engine parts, such as the alternator.

BRAKE FLUID

Checking the brake fluid level

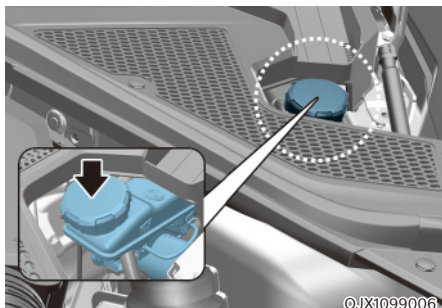

Check the fluid level in the reservoir periodically. The fluid level should be between MAX and MIN marks on the side of the reservoir.

Before removing the reservoir cap and adding brake fluid, clean the area around the reservoir cap thoroughly to prevent brake fluid contamination.

If the level is low, add the specified brake fluid to the MAX level. The level will fall with accumulated kilometers. This is a normal condition associated with the wear of the brake linings. If the fluid level is excessively low, we recommend that the brake system be checked by an authorized retailer of Genesis Branded products.



WARNING

If the brake system requires frequent additions of fluid this could indicate a leak in the brake system. We recommend that the vehicle be inspected by an authorized retailer of Genesis Branded products.



WARNING

Do not allow brake fluid to come in contact with your eyes. If brake fluid comes in contact with your eyes, flush your eyes with clean water for at least 15 minutes and get immediate medical attention.

NOTICE

- **Do not allow brake fluid to contact the vehicle's body paint, as paint damage will result.**
- **Brake fluid, which has been exposed to open air for an extended time should NEVER be used as its quality cannot be guaranteed. It should be disposed of properly.**
- **Do not use the wrong kind of brake fluid. A few drops of mineral based oil, such as engine oil, in your brake system can damage brake system parts.**



Information

Use only the specified brake fluid (refer to “Recommended Lubricants and Capacities” section in chapter 2).

WASHER FLUID

Checking the washer fluid level

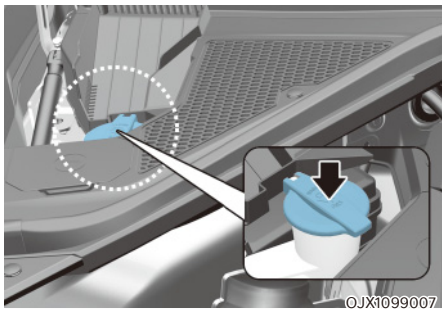

Check the fluid level in the washer fluid reservoir and add fluid if necessary. Plain water may be used if washer fluid is not available. However, use washer solvent with antifreeze characteristics in cold climates to prevent freezing.



WARNING

To prevent serious injury or death, take the following safety precautions when using washer fluid:

- Do not use engine coolant or antifreeze in the washer fluid reservoir. Engine coolant can severely obscure visibility when sprayed on the windshield and may cause loss of vehicle control resulting in an accident or damage to paint and body trim.
- Do not allow sparks or flame to contact the washer fluid or the washer fluid reservoir. Washer fluid may contain alcohol and can be flammable.
- Do not drink washer fluid and avoid contact with skin. Washer fluid is harmful to humans and animals.
- Keep washer fluid away from children and animals.

FUEL FILTER (FOR DIESEL ENGINE)

Draining water from fuel filter

The fuel filter in the diesel engine separates water from fuel and prevents water from accumulating.

When water is accumulated inside the fuel filter, the fuel filter (⚡) warning light illuminates with the Engine Start/Stop button in the ON position.

If this occurs, we recommend that you have the system checked by an authorized retailer of Genesis Branded products.

NOTICE

When accumulated water is not drained at the proper timing, water may permeate in the fuel filter, damaging the major vehicle components, such as the fuel system.

Fuel filter cartridge replacement

We recommend the fuel filter cartridge be replaced by an authorized retailer of Genesis Branded products according to the Maintenance Schedule at the beginning of this chapter.

AIR CLEANER

Filter replacement

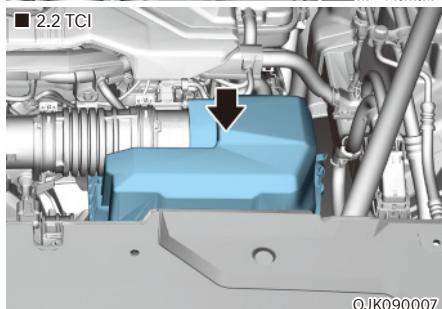
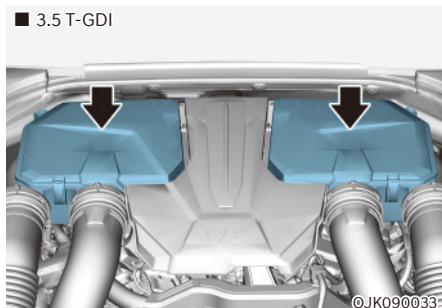
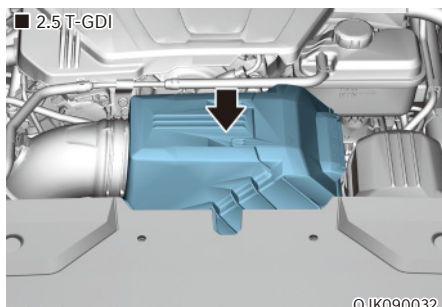

Do not attempt to wash or to rinse it, as water will damage the filter.

If soiled, the air cleaner filter must be replaced.

We recommend that you visit an authorized retailer of Genesis Branded products to replace air cleaner filter. Replace the filter according to the Maintenance Schedule.

i Information

If the vehicle is operated in extremely dusty or sandy areas, replace the air cleaner filter more often than the usual recommended intervals (Refer to “Maintenance Under Severe Usage Conditions” section in this chapter).

NOTICE

- Do not drive with the air cleaner filter removed. This will result in excessive engine wear.
- When removing the air cleaner filter, be careful that dust or dirt does not enter the air intake, or damage may result.
- We recommend that you use parts for replacement from an authorized retailer of Genesis Branded products.
- Do not blow the inner part of the air filter with compressed air. Dust or dirt may enter the air intake.
- Check that the replaced filter is firmly fixed when reassembling the air cleaner filter, and that the clamps are firmly assembled.

CABIN AIR FILTER

Filter inspection

The cabin air filter should be replaced according to the Maintenance Schedule. If the vehicle is operated in severely air-polluted cities or on dusty rough roads for a long period, it should be inspected more frequently and replaced sooner. Replace the cabin air filter by following the procedure below and be careful to avoid damaging other components.

Filter replacement

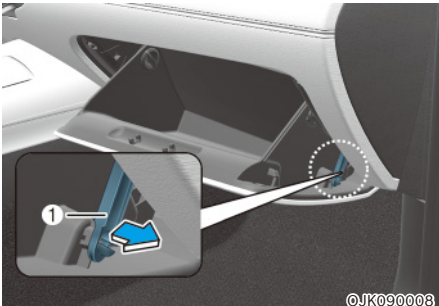

1. Open the glove box and remove the support rod (1).

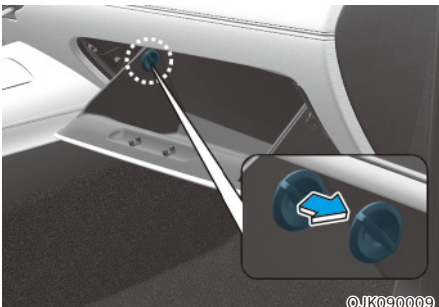

2. Remove the stoppers on both sides to allow the glove box to hang freely on the hinges.

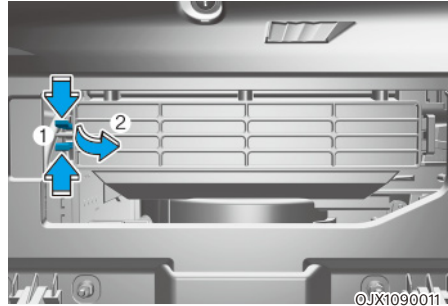

3. Press and hold the lock (1) on the left side of the cover.
4. Pull out (2) the cover.
5. Replace the cabin air filter.
6. Reassemble in the reverse order of disassembly.

NOTICE



Install a new cabin air filter in the correct direction with the arrow symbol (↴) facing downwards, to prevent noise and reduce effectiveness.

WIPER BLADES

Blade inspection

Contamination of either the windshield or the wiper blades with foreign matter can reduce the effectiveness of the windshield wipers.

Common sources of contamination are insects, tree sap, and hot wax treatments used by some commercial car washes. If the blades are not wiping properly, clean both the window and the blades with a good cleaner or mild detergent, and rinse thoroughly with clean water.

NOTICE

To prevent damage to the wiper blades, arms or other components, do not:

- Use gasoline, kerosene, paint thinner, or other solvents on or near them.
- Attempt to move the wipers manually.
- Use non-specified wiper blades.

i Information

Commercial hot waxes applied by automatic car washes have been known to make the windshield difficult to clean.

i Information

Wiper blades are consumable items. Normal wear of the wipers may not be covered by your vehicle warranty.

Blade replacement

When the wipers no longer clean adequately, the blades may be worn or cracked, and require replacement.

NOTICE

- In order to prevent damage to the hood and the wiper arms, the wiper arms should only be lifted when in the top wiping position.
- Always return the wiper arms to the windshield before driving.

Front windshield wiper blade replacement

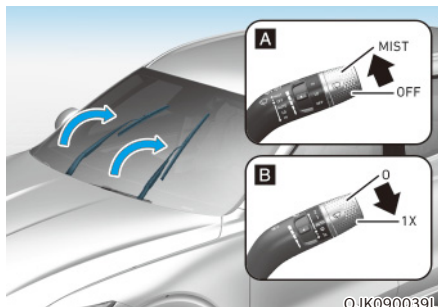

[A] : Type A, [B] : Type B

1. Within 20 seconds of turning off the engine, lift up (or push down) and hold the wiper lever to the MIST (or 1x) position for about 2 seconds until the wipers move to the top wipe position.
2. At this time you can lift the wipers off the windshield.

i Information

This vehicle has a “hidden” wiper design which means that the wipers cannot be lifted manually when they are in their bottom resting position.

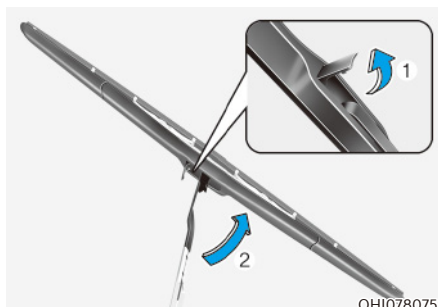

3. Lift up the wiper blade clip (1). Then lift up the wiper blade (2).

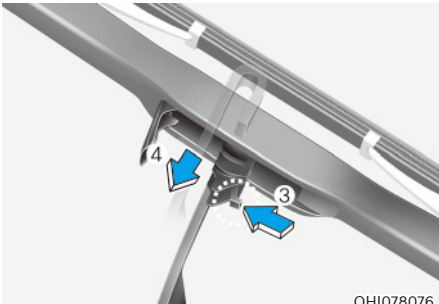

OHI078076

4. While pushing the lock (3), pull down the wiper blade (4).

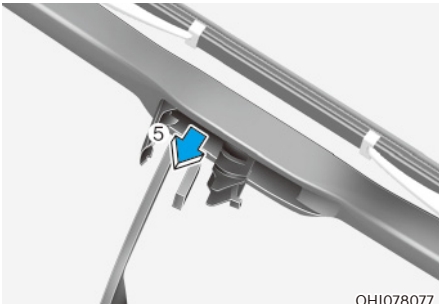

OHI078077

5. Remove the wiper blade from the wiper arm (5).
6. Install a new wiper blade assembly in the reverse order of removal.
7. Gently put the wipers back down onto the windshield.
8. With the Engine Start/Stop button in the ON position, turn the wiper switch to any ON position to return the wipers to the bottom resting position.

Rear window wiper blade replacement

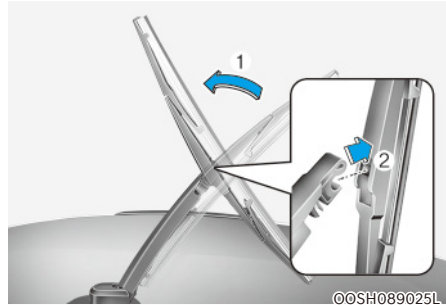

©OSH089025L

1. Raise the wiper arm and then rotate the wiper blade assembly (1).
2. Pull out the wiper blade assembly (2).

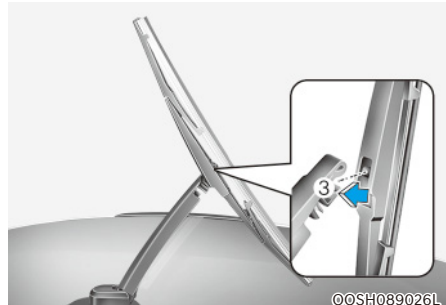

©OSH089026L

3. Install the new blade assembly by inserting the center part into the slot in the wiper arm until it clicks into place (3).
4. Make sure the blade assembly is installed firmly by trying to pull it slightly.
5. Rotate back the blade assembly so that it aligns with the wiper arm.

To prevent damage to the wiper arms or other components, we recommend that you have the wiper blades replaced by an authorized retailer of Genesis Branded products.

BATTERY



WARNING

To prevent **SERIOUS INJURY** or **DEATH** to you or bystanders, always follow these precautions when working near or handling the battery:



Always read and follow instructions carefully when handling a battery.



Wear eye protection designed to protect the eyes from acid splashes.



Keep all flames, sparks, or smoking materials away from the battery.



Hydrogen is always present in battery cells, is highly combustible, and may explode if ignited.



Keep batteries out of reach of children.



Batteries contain sulfuric acid which is highly corrosive. Do not allow acid to contact your eyes, skin or clothing.

If acid gets into your eyes, flush your eyes with clean water for at least 15 minutes and get immediate medical attention. If acid gets on your skin, thoroughly wash the area. If you feel pain or a burning sensation, get medical attention immediately.

- When lifting a plastic-cased battery, excessive pressure on the case may cause battery acid to leak. Lift with a battery carrier or with your hands on opposite corners.
- Do not attempt to jump start your vehicle if your battery is frozen.
- **NEVER** attempt to recharge the battery when the vehicle's battery cables are connected to the battery.
- The electrical ignition system works with high voltage. **NEVER** touch these components with the engine running or when the Engine Start/ Stop button is in the ON position.

NOTICE

- When you do not use the vehicle for a long time in a low temperature area, disconnect the battery and keep it indoors.
- Always charge the battery fully to prevent battery case damage in low temperature areas.

NOTICE

Always follow these instructions when handling your vehicle's battery to prevent damage to your battery:

- When you do not use the vehicle for a long time in a low temperature area, disconnect the battery and keep it indoors.
- Always charge the battery fully to prevent battery case damage in low temperature areas.
- Prevent liquid from wetting the battery terminals. The performance of the battery may be degraded, and may cause injury. Be cautious when loading liquid in the trunk.
- Do not tilt the battery.
- If you connect unauthorized electronic devices to the battery, the battery may be discharged. Never use unauthorized devices.

For best battery service

■ Luggage compartment

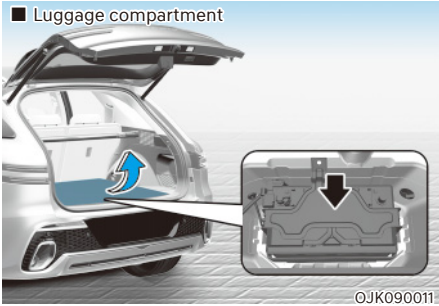

- Keep the battery securely mounted.
- Keep the battery top clean and dry.
- Keep the terminals and connections clean, tight, and coated with petroleum jelly or terminal grease.
- Rinse any spilled electrolyte from the battery immediately with a solution of water and baking soda.
- If the vehicle is not going to be used for an extended time, disconnect the battery cables.

i Information - For batteries marked with UPPER and LOWER

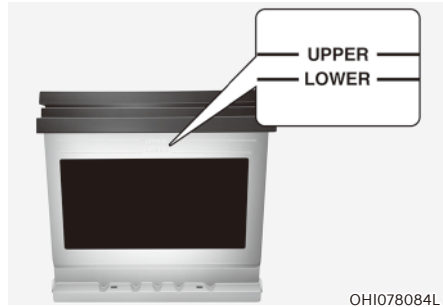

If your vehicle is equipped with a battery marked with LOWER (MIN) and UPPER (MAX) on the side, you should check the electrolyte level.

The electrolyte level should be between LOWER (MIN) and UPPER (MAX). When the electrolyte level is low, add distilled (or de-mineralized) water. (Never add sulfuric acids or other electrolyte).

Be careful not to spill distilled (or demineralized) water over the battery surface or other adjacent components.

Also, do not overfill the battery cells.

If not, it may corrode the battery or other components. Finally, securely close the cell cap. However, we recommend you to contact an authorized retailer of Genesis Branded products for better battery service.

Battery capacity label

■ Type A



OHI078083L

■ Type B



OHI078082L

* The actual battery label in the vehicle may differ from the illustration.

1. AGM105L-DIN : The Genesis Branded Vehicle model name of battery
2. 12V : The nominal voltage
3. 105Ah(20HR) : The nominal capacity (in Ampere hours)
4. RC 190min : The nominal reserve capacity (in min.)
5. 950A : The cold-test current in amperes by SAE / EN

Battery recharging

By battery charger

Your vehicle has a maintenance-free, calcium-based battery.

- If the battery becomes discharged over a short time (because, for example, the headlamps or interior lights were left on while the vehicle was not in use), recharge it by slow charging (trickle) for 10 hours.
- If the battery gradually discharges because of high electrical load while the vehicle is being used, recharge it at 20-30A for two hours.

WARNING

Always follow these instructions when recharging your vehicle's battery to avoid the risk of **SERIOUS INJURY** or **DEATH** from explosions or acid burns:

- Before performing maintenance or recharging the battery, turn off all accessories and stop the engine.
- Keep all flames, sparks, or smoking materials away from the battery.
- Always work outdoors or in an area with plenty of ventilation.
- Wear eye protection when checking the battery during charging.
- The battery must be removed from the vehicle and placed in a well ventilated area.
- Watch the battery during charging, and stop or reduce the charging rate if the battery cells begin boiling violently.

- The negative battery cable must be removed first and installed last when the battery is disconnected. Disconnect the battery charger in the following order:
 1. Turn off the battery charger main switch.
 2. Unhook the negative clamp from the negative battery terminal.
 3. Unhook the positive clamp from the positive battery terminal.
- We recommend that you use batteries for replacement from an authorized retailer of Genesis Branded products.

NOTICE

AGM battery (if equipped)

- Absorbent Glass Matt (AGM) batteries are maintenance-free and we recommend that the AGM battery be serviced by an authorized retailer of Genesis Branded products. For charging your AGM battery, use only fully automatic battery chargers that are specially developed for AGM batteries.
- When replacing the AGM battery, we recommend that you use parts for replacement from an authorized retailer of Genesis Branded products.
- Do not open or remove the cap on top of the battery. This may cause leaks of internal electrolyte that could result in severe injury.

By jump starting

After a jump start from a good battery, drive the vehicle for 20-30 minutes before it is shutoff. The vehicle may not restart if you shut it off before the battery had a chance to adequately recharge. See “Jump Starting” in chapter 8 for more information on jump starting procedures.

Information



An inappropriately disposed battery can be harmful to the environment and human health. Dispose of the battery according to your local law(s) or regulation.

Reset items

The following items may need to be reset after the battery has been discharged or the battery has been disconnected.

- Driving info/Since refueling/Accumulated info (items in Utility view) (see chapter 4)
- Integrated memory system (see chapter 5)
- Power window (see chapter 5)
- Sunroof (see chapter 5)
- Power tailgate (see chapter 5)
- Climate control system (see chapter 5)
- Clock (see Infotainment system manual)
- Infotainment system (see Infotainment system manual)

TIRES AND WHEELS



WARNING

Tire failure may cause loss of vehicle control resulting in an accident. To reduce risk of **SERIOUS INJURY** or **DEATH**, take the following precautions:

- Inspect your tires monthly for proper inflation as well as wear and damage.
- The recommended cold tire pressure for your vehicle can be found in this manual and on the tire label located on the driver's side center pillar. Always use a tire pressure gauge to measure tire pressure. Tires with too much or too little pressure wear unevenly causing poor handling.
- Check the pressure of the spare every time you check the pressure of the other tires on your vehicle.
- Replace tires that are worn, show uneven wear, or are damaged. Worn tires can cause loss of braking effectiveness, steering control, or traction.
- **ALWAYS** replace tires with the same size, type, construction and tread pattern as each tire that was originally supplied with this vehicle. Using tires and wheels other than the recommended sizes could cause unusual handling characteristics, poor vehicle control, or negatively affect your vehicle's Anti-Lock Brake System (ABS) resulting in a serious accident.

Tire care

For proper maintenance, safety, and maximum fuel economy, you must always maintain recommended tire inflation pressures and stay within the load limits and weight distribution recommended for your vehicle.



All specifications (sizes and pressures) can be found on a label attached to the driver's side center pillar.

Recommended cold tire inflation pressures

All tire pressures (including the spare) should be checked when the tires are cold. "Cold tires" means the vehicle has not been driven for at least three hours or driven less than 1.6 km (one mile).

Warm tires normally exceed recommended cold tire pressures by 28 to 41 kPa (4 to 6 psi). Do not release air from warm tires to adjust the pressure or the tires will be under-inflated. For recommended inflation pressure, refer to "Tire and Wheels" section in chapter 2.



WARNING

Recommended pressures must be maintained for the best ride, vehicle handling, and minimum tire wear.

Over-inflation or under-inflation can reduce tire life, adversely affect vehicle handling, and lead to sudden tire failure that could result in loss of vehicle control resulting in an accident.

Severe under-inflation can lead to severe heat build-up, causing blowouts, tread separation and other tire failures that can result in the loss of vehicle control resulting in an accident. This risk is much higher on hot days and when driving for long periods at high speeds.



CAUTION

- Under-inflation results in excessive wear, poor handling and reduced fuel economy. Wheel deformation is also possible. Keep your tire pressures at the proper levels. If a tire frequently needs refilling, we recommend it be checked by an authorized retailer of Genesis Branded products.
- Over-inflation produces a harsh ride, excessive wear at the center of the tire tread, and a greater possibility of damage from road hazards.

Check tire inflation pressure

Check your tires, including the spare tire, once a month or more.

How to check

Use a good quality tire pressure gauge to check tire pressure. You can not tell if your tires are properly inflated simply by looking at them. Radial tires may look properly inflated when they are under-inflated.

Remove the valve cap from the tire valve stem. Press the tire gauge firmly onto the valve to get a pressure measurement. If the cold tire inflation pressure matches the recommended pressure on the tire and loading information label, no further adjustment is necessary. If the pressure is low, add air until you reach the recommended pressure. Make sure to put the valve caps back on the valve stems. Without the valve cap, dirt or moisture could get into the valve core and cause air leakage. If a valve cap is missing, install a new one as soon as possible.

If you overfill the tire, release air by pushing on the metal stem in the center of the tire valve. Recheck the tire pressure with the tire gauge. Be sure to put the valve caps back on the valve stems. Without the valve cap, dirt or moisture could get into the valve core and cause air leakage. If a valve cap is missing, install a new one as soon as possible.

Tire rotation

To equalize tread wear, Genesis Branded Vehicle recommends that the tires be rotated every 12,000 km (7,500 miles) or sooner if irregular wear develops.

During rotation, check the tires for correct balance.

When rotating tires, check for uneven wear and damage. Abnormal wear is usually caused by incorrect tire pressure, improper wheel alignment, out-of-balance wheels, severe braking or severe cornering. Look for bumps or bulges in the tread or side of the tire. Replace the tire if you find any of these conditions. Replace the tire if fabric or cord is visible. After rotation, be sure to bring the front and rear tire pressures to specification and check wheel bolt tightness (proper torque is 14~16 kgf.m [101~116 lbf.ft]).

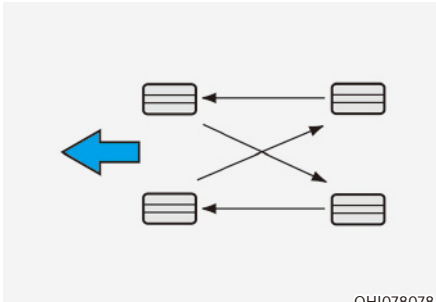

OHI078078

Disc brake pads should be inspected for wear whenever tires are rotated.

i Information

The outside and inside of the unsymmetrical tire is distinguishable. When installing an unsymmetrical tire, be sure to install the side marked “outside” face the outside. If the side marked “inside” is installed on the outside, it will have a negative effect on vehicle performance.

! WARNING

- Do not use the compact spare tire for tire rotation.
- Do not mix bias ply and radial ply tires under any circumstances. This may cause unusual handling characteristics that may cause loss of vehicle control resulting in an accident.

Wheel alignment and tire balance

The wheels on your vehicle were aligned and balanced carefully at the factory to give you the longest tire life and best overall performance.

In most cases, you will not need to have your wheels aligned again. However, if you notice unusual tire wear or your vehicle pulling one way or the other, the alignment may need to be reset.

If you notice your vehicle vibrating when driving on a smooth road, your wheels may need to be rebalanced.

NOTICE

Incorrect wheel weights can damage your vehicle's aluminum wheels. Use only approved wheel weights.

Tire replacement



If the tire is worn evenly, a tread wear indicator will appear as a solid band across the tread. This shows there is less than 1.6 mm (1/16 in.) of tread left on the tire. Replace the tire when this happens.

Do not wait for the band to appear across the entire tread before replacing the tire.



WARNING

To reduce the risk of **DEATH** or **SERIOUS INJURY**:

- **Replace tires that are worn, show uneven wear, or are damaged. Worn tires can cause loss of braking effectiveness, steering control, and traction.**
- **Always replace tires with the same size as each tire that was originally supplied with this vehicle. Using tires and wheels other than the recommended sizes could cause unusual handling characteristics, poor vehicle control, or negatively affect your vehicle's Anti-Lock Brake System (ABS) resulting in a serious accident.**
- **When replacing tires (or wheels), it is recommended to replace the two front or two rear tires (or wheels) as a pair. Replacing just one tire can seriously affect your vehicle's handling.**
- **Tires degrade over time, even when they are not being used. Regardless of the remaining tread, Genesis Branded Vehicle recommends that tires be replaced after six (6) years of normal service.**
- **Heat caused by hot climates or frequent high loading conditions can accelerate the aging process. Failure to follow this warning may cause sudden tire failure, which could lead to a loss of vehicle control resulting in an accident.**

Compact spare tire replacement (if equipped)

A compact spare tire has a shorter tread life than a regular size tire. Replace it when you can see the tread wear indicator bars on the tire. The replacement compact spare tire should be the same size and design tire as the one provided with your new vehicle and should be mounted on the same compact spare tire wheel. The compact spare tire is not designed to be mounted on a regular size wheel, and the compact spare tire wheel is not designed for mounting a regular size tire.



WARNING

The original tire should be repaired or replaced as soon as possible to avoid failure of the spare and loss of vehicle control resulting in an accident. The compact spare tire is for emergency use only. Do not operate your vehicle over 80 km/h (50 mph) when using the compact spare tire.

Wheel replacement

When replacing the metal wheels for any reason, make sure the new wheels are equivalent to the original factory units in diameter, rim width and offset.

Tire traction

Tire traction can be reduced if you drive on worn tires, tires that are improperly inflated or on slippery road surfaces. Tires should be replaced when tread wear indicators appear. To reduce the possibility of losing control, slow down whenever there is rain, snow or ice on the road.

Tire maintenance

In addition to proper inflation, correct wheel alignment helps to decrease tire wear. If you find a tire is worn unevenly, have your dealer check the wheel alignment.

When you have new tires installed, make sure they are balanced. This will increase vehicle ride comfort and tire life. Additionally, a tire should always be rebalanced if it is removed from the wheel.

Tire sidewall labeling

This information identifies and describes the fundamental characteristics of the tire and also provides the tire identification number (TIN) for safety standard certification. The TIN can be used to identify the tire in case of a recall.

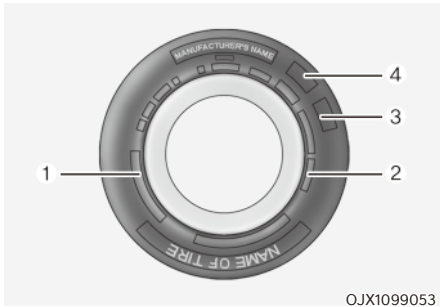

OJX1099053

1. **Manufacturer or brand name**

Manufacturer or brand name is shown.

2. **Tire size designation**

A tire's sidewall is marked with a tire size designation. You will need this information when selecting replacement tires for your car. The following explains what the letters and numbers in the tire size designation mean.

Example tire size designation:

(These numbers are provided as an example only; your tire size designator could vary depending on your vehicle.)

235/60R18 107W

235 - Tire width in millimeters.

60 - Aspect ratio. The tire's section height as a percentage of its width.

R - Tire construction code (Radial).

18 - Rim diameter in inches.

107 - Load Index, a numerical code associated with the maximum load the tire can carry.

W - Speed Rating Symbol. See the speed rating chart in this section for additional information.

Wheel size designation

Wheels are also marked with important information that you need if you ever have to replace one. The following explains what the letters and numbers in the wheel size designation mean.

Example wheel size designation:

8.0J X 18

8.0 - Rim width in inches.

J - Rim contour designation.

18 - Rim diameter in inches.

Tire speed ratings

The chart below lists many of the different speed ratings currently being used for passenger vehicle tires. The speed rating is part of the tire size designation on the sidewall of the tire. This symbol corresponds to that tire's designed maximum safe operating speed.

Speed Rating Symbol	Maximum Speed
S	180 km/h (112 mph)
T	190 km/h (118 mph)
H	210 km/h (130 mph)
V	240 km/h (149 mph)
W	270 km/h (168 mph)
Y	300 km/h (186 mph)

3. Checking tire life (TIN : Tire Identification Number)

Any tires that are over six years old, based on the manufacturing date, (including the spare tire) should be replaced by new ones. You can find the manufacturing date on the tire sidewall (possibly on the inside of the wheel), displaying the DOT Code. The DOT Code is a series of numbers on a tire consisting of numbers and English letters. The manufacturing date is designated by the last four digits (characters) of the DOT code.

DOT : XXXX XXXX OOOO

The front part of the DOT shows a plant code number, tire size and tread pattern and the last four numbers indicate week and year manufactured.

For example:

DOT XXXX XXXX 5221 represents that the tire was produced in the 52nd week of 2021.

4. Genesis exclusive tire

Genesis Branded Vehicle recommends that tires designed specifically for Genesis vehicles be used. You may find the marking "GOE" (Genesis Original Equipment) embossed on the tire sidewall.

5. Tire ply composition and material

The number of layers or plies of rubber-coated fabric in the tire. Tire manufacturers also must indicate the materials in the tire, which include steel, nylon, polyester, and others. The letter "R" means radial ply construction; the letter "D" means diagonal or bias ply construction; and the letter "B" means belted-bias ply construction.

6. Maximum permissible inflation pressure

This number is the greatest amount of air pressure that should be put in the tire. Do not exceed the maximum permissible inflation pressure. Refer to the Tire and Loading Information label for recommended inflation pressure.

7. Maximum load rating

This number indicates the maximum load in kilograms and pounds that can be carried by the tire. When replacing the tires on the vehicle, always use a tire that has the same load rating as the factory installed tire.

8. Uniform tire quality grading

Quality grades can be found where applicable on the tire sidewall between tread shoulder and maximum section width.

For example:

TREADWEAR 200

TRACTION AA

TEMPERATURE A

Tread wear

The tread wear grade is a comparative rating based on the wear rate of the tire when tested under controlled conditions on a specified government test course. For example, a tire graded 150 would wear one-and-a-half times (1½) as well on the government course as a tire graded 100.

The relative performance of tires depends upon the actual conditions of their use, however, and may depart significantly from the norm due to variations in driving habits, service practices and differences in road characteristics and climate.

These grades are molded on the sidewalls of passenger vehicle tires. The tires available as standard or optional equipment on your vehicle may vary with respect to grade.

Traction - AA, A, B & C

The traction grades, from highest to lowest, are AA, A, B and C. Those grades represent the tire's ability to stop on wet pavement as measured under controlled conditions on specified government test surfaces of asphalt and concrete. A tire marked C may have poor traction performance.



WARNING

The traction grade assigned to this tire is based on straight ahead braking traction tests, and does not include acceleration, cornering, hydroplaning, or peak traction characteristics.

Temperature - A, B & C

The temperature grades are A (the highest), B and C representing the tire's resistance to the generation of heat and its ability to dissipate heat when tested under controlled conditions on a specified indoor laboratory test wheel.

Sustained high temperature can cause the material of the tire to degenerate and reduce tire life, and excessive temperature can lead to sudden tire failure. Grades B and A represent higher levels of performance on the laboratory test wheel than the minimum required by law.



WARNING

The temperature grade for this tire is established for a tire that is properly inflated and not overloaded. Excessive speed, under-inflation, over-inflation, or excessive loading, either separately or in combination, can cause heat build-up and possible sudden tire failure. This may cause loss of vehicle control resulting in an accident.

Low aspect ratio tires (if equipped)

The aspect ratio is lower than 50 on low aspect ratio tires.

Because low aspect ratio tires are optimized for handling and braking, their sidewall is a little stiffer than a standard tire. Also low aspect ratio tires tend to be wider and consequently have a greater contact patch with the road surface. In some instances they may generate more road noise compared with standard tires.



CAUTION

The side wall of a low aspect ratio tire is shorter than the normal one. Thus, the low-aspect wheel and tire are easily damaged. Follow the below instructions.

- When driving on a rough road or driving off a road, be careful not to damage the tires and wheels. After driving, inspect the tires and wheels.
- When passing over a pothole, speed bump, manhole, or curb stone, drive the vehicle slowly so as not to damage the tires and wheels.
- When there is an impact on a tire, inspect the tire condition. Or, you can contact an authorized retailer of Genesis Branded products.
- Inspect the tire condition and pressure every 3,000 km (1,800 miles) to prevent tire damage.
- It is difficult to recognize a tire damage only with your eyes. When there is a slight hint of a tire damage, check and replace the tire to prevent the damage caused by air leakage.
- When a tire is damaged while driving on a rough road, off a road, or over obstacles, such as a pothole, manhole, or curb stone, your warranty does not cover the damage.
- The tire information is specified on the tire side wall.

FUSES

■ Blade type



■ Cartridge type



■ Multi type

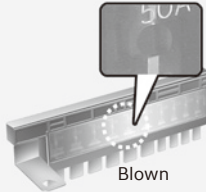
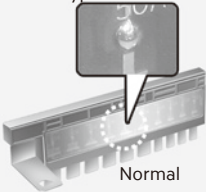

■ Midi type



OCK077071

A vehicle's electrical system is protected from electrical overload damage by fuses.

This vehicle has 5 fuse panels, one located in the driver's side panel bolster, the other in the engine compartment.

If any of your vehicle's lights, accessories, or controls do not work, check the appropriate circuit fuse. If a fuse has blown, the element inside the fuse will be melted or broken.

If the electrical system does not work, first check the driver's side fuse panel. Before replacing a blown fuse, turn the engine and all switches off, and then disconnect the negative battery cable. Always replace a blown fuse with one of the same rating.

If the replacement fuse blows, this indicates an electrical problem. Avoid using the system involved. We recommend that you immediately consult an authorized retailer of Genesis Branded products.



WARNING

NEVER replace a fuse with anything but another fuse of the same rating.

- A higher capacity fuse could cause damage and possibly cause a fire.
- Do not install a wire or aluminum foil instead of the proper fuse - even as a temporary repair. It may cause extensive wiring damage and possibly a fire.

NOTICE

Do not use a screwdriver or any other metal object to remove fuses because it may cause a short circuit and damage the system.

Instrument panel fuse replacement

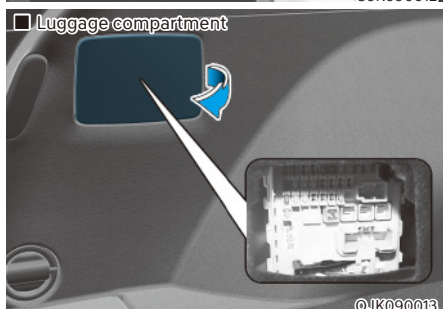
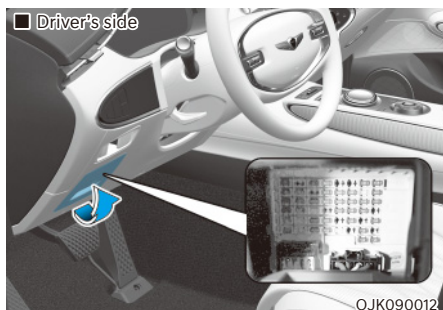

1. Turn the vehicle off.
2. Turn all other switches off.
3. Open the fuse panel cover.
4. Refer to the label on the inside of the fuse panel cover to locate the suspected fuse location.

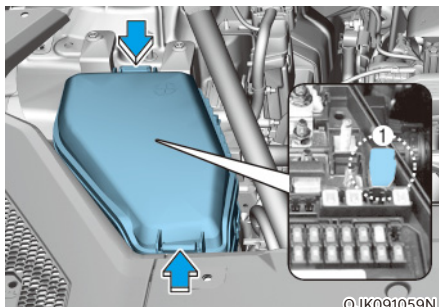

5. Pull the suspected fuse straight out. Use the removal tool (1) provided in the engine compartment fuses panel cover.
6. Check the removed fuse; replace it if it is blown. Spare fuses are provided in the instrument panel fuse panels (or in the engine compartment fuse panel).
7. Push in a new fuse of the same rating, and make sure it fits tightly in the clips. If it fits loosely, we recommend that you consult an authorized retailer of Genesis Branded products.

In an emergency, if you do not have a spare fuse, use a fuse of the same rating from a circuit you may not need for operating the vehicle, such as the cigarette lighter fuse.

If the headlamps or other electrical components do not work and the fuses are undamaged, check the fuse panel in the engine compartment. If a fuse is blown, it must be replaced with the same rating.

Engine compartment panel fuse replacement

Blade fuse / Cartridge fuse

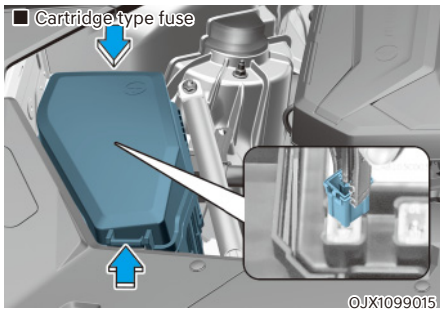
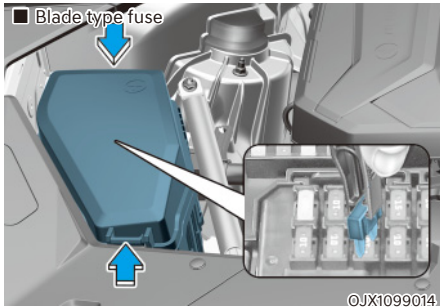

1. Turn the vehicle off.
2. Turn all other switches off.
3. Remove the fuse panel cover by pressing the tap and pulling up.
4. Check the removed fuse; replace it if it is blown. To remove or insert the fuse, use the fuse puller in the engine compartment fuse panel.
5. Push in a new fuse of the same rating, and make sure it fits tightly in the clips. If it fits loosely, we recommend that you consult an authorized retailer of Genesis Branded products.

NOTICE

After checking the fuse panel in the engine compartment, securely install the fuse panel cover. You may hear a clicking sound if the cover is securely latched. If it is not securely latched, electrical failure may occur from water contact.

Multi fuse / Midi fuse

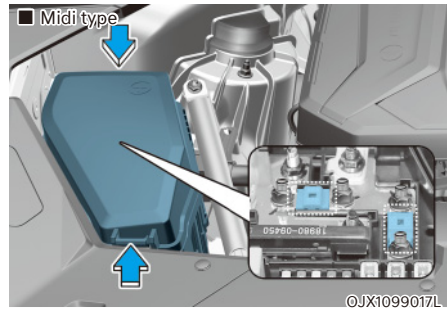
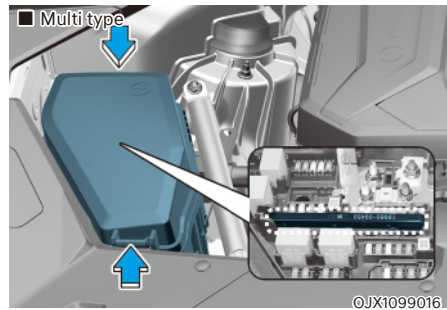

If the multi fuse or midi fuse is blown, we recommend that you consult an authorized retailer of Genesis Branded products.

Fuse/relay panel description

Instrument panel fuse panel

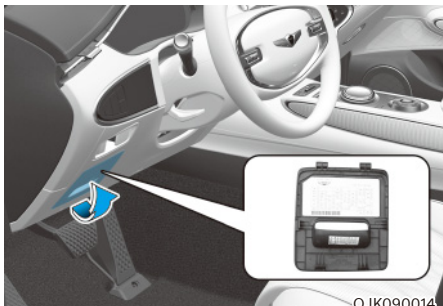

OJK090014

Inside the fuse/relay box cover, you can find the fuse/relay label describing fuse/relay names and ratings.

i Information

Not all fuse panel descriptions in this manual may be applicable to your vehicle; the information is accurate at the time of printing. When you inspect the fuse box on your vehicle, refer to the fuse box label.

91.990-ARO30



USE THE DESIGNATED FUSE ONLY
 USE SOLO LOS FUSIBLES ESPECIFICADOS
 ИСПОЛЗУЙТЕ ТОЛЬКО ПРЕДНАЗНАЧЕННЫЕ ПРЕДОХРАНИТЕЛИ
 استخدم فقط المصهرات المحددة

9 MODULE 10A				11 MODULE 10A				12 MODULE 10A	3 A/C 10A
IND 10A	2 E-SHIFTER 10A			SPARE 15A	10 MODULE 10A			MULTI MEDIA 25A	13 MODULE 10A
CLUSTER 10A	2 IBU 10A	2 PASS 15A		3 RESAFTY BEAT BELT 10A	8 MODULE 10A			E-CALL 10A	3 MODULE 10A
FRT-REAR 30A	1 DRV 25A	2 PASS 25A			1 E-SHIFTER 15A			4 MODULE 10A	
2 DRV 25A	1 PASS 25A	DRV 15A	ECS 15A	POWER HANDLE 15A	1 IBU 20A				14 MODULE 10A
								6 MODULE 10A	
									BRAKE SWITCH 10A

OJK090042L

Instrument panel fuse panel

Fuse Name	Symbol	Fuse Rating	Circuit Protected
MODULE9	⁹ MODULE	10A	Overhead Console Lamp, AMP, Driver Power Seat Module, Low DC-DC Converter (AMP), Electro Chromic Mirror, Passenger Power Seat Module, Data Link Connector, DVRS Unit, Front A/C Controller, Smart Phone Wireless Charger, Rear A/C Control Panel, A/V & Navigation Head Unit, A/C Control Module, MTS E-Call Module, Rear Seat Warmer Control Module, Rear Air Ventilation Seat Control Module, Fingerprint Recognition Device,
MODULE11	¹¹ MODULE	10A	Head Lamp LH/RH, Multifunction Switch, AC Inverter, ADAS Unit (Parking), AC Inverter Outlet, Rear Junction Block (Rear Wiper Relay)
MODULE12	¹² MODULE	10A	IAU, IBU
A/C3	³ A/C	10A	E/R SUB Junction Block(RLY.2/3/5/7/10), Incar Temperature Sensor, A/C Control Module, Rear A/C Controller, Front A/C Controller
A/BAG IND	^{IND} 	10A	Instrument Cluster, Overhead Console Lamp
E-SHIFTER2	² E-SHIFTER	10A	Electronic ATM Shift Lever Dial
MODULE10	¹⁰ MODULE	10A	ICU Junction Block (ESU)
MODULE7	⁷ MODULE	10A	Driver Door Module, IBU, Multifunction Switch, IAU, [G4KR/G6DS] Stop Lamp Switch
MULTI MEDIA	¹ MULTI MEDIA	25A	With ISG] Low DC-DC Converter [W/O ISG] A/V & Navigation Head Unit









Instrument panel fuse panel

Fuse Name	Symbol	Fuse Rating	Circuit Protected
MODULE13	¹³ MODULE	10A	Head-Up Display, Instrument Cluster, Security Indicator, A/C Control Module, Front/Rear A/C Controller, Driver/Passenger Power Outside Mirror, Crash Pad Switch, Driver Power Seat Switch, A/V & Navigation Keyboard, Front Console Switch, Fingerprint Recognition Device, DVRS Unit, Carnish Mood Lamp RH, Mood Lamp Unit, Console Mood Lamp
CLUSTER	CLUSTER	10A	Instrument Cluster, Head-Up Display
IBU2	² IBU	10A	IBU
AIR BAG2	² 	15A	SRS Control Module
PRESAFETY SEAT BELT3	³ PRESAFETY SEAT BELT	10A	Pre-Active Seat Belt Unit
MODULE8	⁸ MODULE	10A	Rear Radar LH/RH, ECS Unit, ELSD Control Module, Dosing Control Module, ADAS Unit (Driving), ADAS Unit (Parking), LKAS Unit, Crash Pad Switch Steering Tilt & Telescopic Unit, EMC Control Module
MODULE5	⁵ MODULE	10A	UIP Sensor, Rain Sensor
E-CALL	E-CALL	10A	MTS E-Call Module
MODULE3	³ MODULE	10A	Rear Radar LH/RH, Front Radar LH/RH, Clock Spring, Smart Phone Wireless Charger, Front Console Keyboard, Steering Tilt & Telescopic Unit, Active Air Flap Module, Multifunction Switch, Rear Occupant Alert (ROA) Sensor

Instrument panel fuse panel

Fuse Name	Symbol	Fuse Rating	Circuit Protected
FRONT/REAR P/WINDOW	^{FRT/REAR} 	30A	Driver/Passenger Power Window Module, Rear Power Window Module LH
P/SEAT		10A	Driver Lumbar Support Unit
P/SEAT PASS2	² PASS 	25A	Passenger Power Seat Module, Passenger Power Seat Switch
AIR BAG1	¹ 	15A	SRS Control Module
E-SHIFTER1	¹ E-SHIFTER	10A	Electronic ATM Shift Lever Dial
MODULE4	⁴ MODULE	10A	Data Link Connector, Passenger Power Seat Switch, Power Tail Gate Unit, Driver Power Seat Module, Driver Power Seat Switch, Driver Lumbar Support Unit, Passenger Power Seat Module, Driver Mood Lamp,
SUN ROOF1	¹ 	25A	Sunroof Control Unit (Master)
P/SEAT DRV1	¹ DRV 	25A	[With IMS] Driver Power Seat Module [W/O IMS] Driver Power Seat Switch
ECS	ECS	15A	ECS Unit
POWER HANDLE	POWER HANDLE	15A	Steering Tilt & Telescopic Unit
IBU1	¹ IBU	10A	IAU, IBU, BLE Unit, Driver/Passenger Door Outside Handle

Instrument panel fuse panel

Fuse Name	Symbol	Fuse Rating	Circuit Protected
MODULE14	¹⁴ MODULE 	10A	Front Radar LH/RH, Rear Radar LH/RH, Head-Up Display, Smart Phone Wireless Charger, Instrument Cluster, Front A/C Controller, Front Console Keyboard, Rear A/C Control Panel
P/SEAT DRV2	² DRV 	25A	With IMS] Driver Power Seat Module [W/O IMS] Driver Power Seat Switch
P/SEAT PASS1	¹ PASS 	25A	[With Walk In] Passenger Power Seat Module [W/O Walk In] Passenger Power Seat Switch
S/HEATER DRV	DRV 	15A	Driver Power Seat Module
S/HEATER PASS1	¹ PASS 	25A	Passenger Power Seat Module
DOOR LOCK		20A	Center Door Lock Relay, Center Door Unlock Relay
MODULE6	⁶ MODULE 	10A	DVRS Unit, Armrest Lamp, IBU, Low DC-DC Converter, Electronic ATM Shift Lever Dial, Front Console Keyboard, A/V & Navigation Head Unit, Rear USB Charger, ADAS Unit (Parking), MTS E-Call Module, IAU, AMP, E/R Sub Junction Block (RLY.6/9)
BRAKE SWITCH	BRAKE SWITCH 	10A	Stop Lamp Switch, IBU

**Engine compartment fuse panel
(Engine room junction block)**

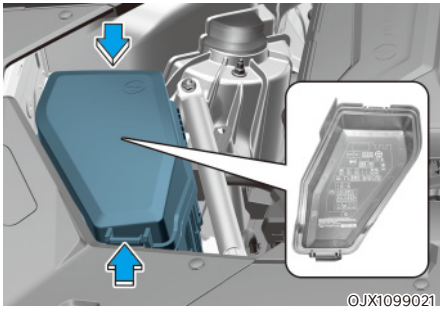

©JX1099021

Inside the fuse/relay box cover, you can find the fuse/relay label describing fuse/relay names and ratings.









i Information

Not all fuse panel descriptions in this manual may be applicable to your vehicle; the information is accurate at the time of printing. When you inspect the fuse panel in your vehicle, refer to the fuse panel label.











OJK090043L







Engine compartment fuse panel (Engine room junction block)

Type	Fuse Name	Symbol	Fuse Rating	Circuit Protected
MINE	MDPS1	¹  ¹	100A	MDPS Unit
	ALT	ALT	225A	Alternator
	B+7	⁷ 	150A	[RHD] E/R Sub Junction Block
MULTI	E-CVVT1	¹ E-cvvt	40A	E-CVVT Relay (RLY.1)
	OIL PUMP	OIL PUMP	50A	Electronic Oil Pump
	COOLING FAN2	² 	60A	Cooling Fan Motor
	GLOW		80A	Glow Unit
	COOLING FAN1	¹ 	100A	Cooling Fan Motor
SB	HEAD LAMP LH	^{LH} 	30A	Head Lamp LH
	START		30A	Start Relay (RLY.2)
	HEAD LAMP RH	^{RH} 	30A	Head Lamp RH
	FUEL HEATER		30A	[D4HF] Fuel Heater Relay (RLY.6)







Engine compartment fuse panel (Engine room junction block)

Type	Fuse Name	Symbol	Fuse Rating	Circuit Protected
MICRO	FUEL PUMP		20A	Fuel Pump Relay (RLY.4)
	AWD		20A	AWD ECU
	ECU1		15A	ECM
	TCU1		20A	TCM
	MODULE1		10A	EMC Solenoid LH/RH
	HORN		15A	PCB Block(Horn Relay)
	A/C1		15A	A/C Relay (RLY.5)
	E-CVVT2		20A	[G4KR] ECM
	E-CVVT3		20A	[G4KR] ECM





Engine compartment fuse panel (Engine room junction block)

Fuse Name	Symbol	Fuse Rating	Circuit Protected
IG1	IG1	30A	IG1 Relay
ECU3	 E3	30A	Engine Control Realy
IG2	IG2	30A	IG2 Relay
ACC	ACC	30A	ACC Relay
ECU2	 E2	10A	ECM
MODULE2	2 MODULE	10A	Smart Cruise Control Radar, Front Radar LH/RH, AWD ECU
MDPS2	 2 1	10A	MDPS Unit
ACTIVE HOOD		10A	Active Hood Unit
SENSOR3	 S3	10A	[G4KR] Oxygen Sensor (Up/Down), E/R Sub Junction Block (RLY.4) [D4HF] PTC Control Heater, Electronic VGT Actuator, Oil Pump Solenoid Valve, High Pressure EGR Cooler Bypass Valve
SENSOR1	 S1	10A	[G4KR] Injector #1-#4, E/R Junction Block (RLY.4) [G6DS] Injector #1-#6(MPI), E/R Junction Block (RLY.4) [D4HF] Rail Pressure Control Valve, E/R Junction Block (RLY.4/RLY.6)





Engine compartment fuse panel (Engine room junction block)

Fuse Name	Symbol	Fuse Rating	Circuit Protected
SENSOR4		15A	Cooling Fan Motor, [D4HF] High Pressure Fuel Pump
WASHER		15A	Washer Relay, E/R Junction Block (RLY.3)
EWP	EWP	20A	Electronic Water Pump
SENSOR5		10A	Diesel Fuel Heater, Glow Unit
IEB4	⁴ IEB	10A	IEB Unit
TCU2		15A	P/N Relay, TCM, Electronic Oil Pump
SENSOR2		10A	[G4KR] E/R Junction Block (RLY.5), Oil Control Valve (Exhaust), Oil Pump Solenoid Valve, Purge Control Solenoid Valve, RCV Control Solenoid Valve [G6DS] E/R Junction Block (RLY.5), RCV Control Solenoid Valve #1/#2, Purge Control Solenoid Valve, Oil Pump Solenoid Valve, Oxygen Sensor #1-#4, Oil Control Valve #1-#4 [D4HF] E/R Junction Block (RLY.5), PM (Particulate Matter) Sensor, Lambda Sensor (Up/Down), Oil Level Sensor, Stop Lamp Switch, Electronic Thermostat
IGN COIL	IGN COIL	15A	[G4KR] Ignition Coil #1-#4 [G6D8] Ignition Coil #1-#6
ECU4		20A	ECM









Engine compartment fuse panel (Engine room sub junction block) (LHD)

Type	Fuse Name	Symbol	Fuse Rating	Circuit Protected
SB	PTC HEATER1	¹ PTC HEATER	30A	[D4HF] PTC Heater 1 Relay (RLY.4)
	PTC HEATER2	² PTC HEATER	30A	[D4HF] PTC Heater 2 Relay (RLY.3)
	PTC HEATER3	³ PTC HEATER	30A	[D4HF] PTC Heater 3 Relay (RLY.2)
	INVERTER	INVERTER	30A	AC Inverter
	WIPER FRT	^{FRT} 	30A	Wiper Motor
	IEB 3	³ IEB	40A	IEB Unit, Multipurpose Check Connector
	POWER OUTLET 1	¹ POWER OUTLET	40A	Power Outlet1 Relay (RLY.6)
	REAR HEATED		40A	Rear Heated Relay (RLY.7)
	IEB 1	¹ IEB	60A	IEB Unit
	IEB 2	² IEB	60A	IEB Unit
BLOWER		40A	Blower Relay (RLY.10)	
MICRO	BURGLAR ALARM HORN		15A	Burglar Alarm Horn Relay (RLY.8)
	POWER OUTLET 2	² POWER OUTLET	20A	Luggage Power Outlet
	A/C 2	² A/C	10A	A/C Control Module
	REAR HEATED		10A	Front A/C Controller
	POWER OUTLET 3	³ POWER OUTLET	20A	Front Power Outlet

Engine compartment fuse panel (Engine room sub junction block) (RHD)

Type	Fuse Name	Symbol	Fuse Rating	Circuit Protected
SB	PTC HEATER1	¹ PTC HEATER	30A	[D4HF] PTC Heater 1 Relay (RLY.4)
	PTC HEATER2	² PTC HEATER	30A	[D4HF] PTC Heater 2 Relay (RLY.5)
	PTC HEATER3	³ PTC HEATER	30A	[D4HF] PTC Heater 3 Relay (RLY.2)
	POWER OUTLET	POWER OUTLET	40A	Power Outlet Relay (RLY.9)
	WIPER FRT	^{FRT} 	30A	Wiper Motor
	INVERTER	INVERTER	30A	AC Inverter
	IEB 3	³ IEB	40A	IEB Unit, Multipurpose Check Connector
	REAR HEATED		40A	Rear Heated Relay (RLY.11)
	IEB 1	¹ IEB	60A	IEB Unit
	IEB 2	² IEB	60A	IEB Unit
	BLOWER		40A	Blower Relay (RLY.7)
MICRO	A/C 2	² A/C	10A	A/C Control Module
	POWER OUTLET 3	² POWER OUTLET	20A	Front Power Outlet
	POWER OUTLET 2	³ POWER OUTLET	20A	Luggage Power Outlet
	REAR HEATED		10A	Front A/C Controller
	BURGLAR ALARM HORN		15A	Burglar Alarm Horn Relay (RLY.4)

Luggage compartment (Rear sub junction block)

Fuse Name	Symbol	Fuse Rating	Circuit Protected
B+2	² 	30A	ICU Junction Block (IPS2, IPS5, Fuse - F22, F29, F30, F38, F47)
DCU3	³ DCU	20A	Dosing Control Module
DCU4	⁴ DCU	10A	NOX Sensor (FRT), NOX Sensor (RR)
CHILD LOCK		15A	Child Lock/Unlock Relay
DCU1	¹ DCU	20A	Dosing Control Module
P/WINDOW RH	^{RH} 	30A	Rear Power Window Module RH, Driver/Passenger Power Window Module
DCU2	² DCU	20A	Dosing Control Module
AMP	AMP	25A	[W/O ISG] AMP [With ISG] Low DC-DC Converter (AMP)
PRESAFETY SEAT BELT1	¹ PRESAFETY SEAT BELT	30A	Pre-Active Seat Belt Unit
WIPER RR		15A	Rear Wiper Relay, Rear Wiper Motor
S/HEATER PASS	² PASS 	15A	Not Used
PRESAFETY SEAT BELT2	² PRESAFETY SEAT BELT	30A	Pre-Active Seat Belt Unit
CURTAIN	E-LSD	20A	ELSD Control Module
S/HEATER RR1	¹ RR 	20A	Rear Air Ventilation Seat Control Module, Rear Seat Warmer Control Module
POWER T/ GATE		30A	Power Tail Gate Unit
S/HEATER RR2	² RR 	20A	Rear Air Ventilation Seat Control Module, Rear Seat Warmer Control Module

Luggage compartment (Battery junction block)



OJK090029

Inside the fuse/relay box cover, you can find the fuse/relay label describing fuse/relay names and ratings.







i Information

Not all fuse panel descriptions in this manual may be applicable to your vehicle; the information is accurate at the time of printing. When you inspect the fuse panel in your vehicle, refer to the fuse panel label.

	<table border="1" style="font-size: 8px; border-collapse: collapse;"> <tr><td>W/CHARGER</td><td>AMS</td><td>DA</td></tr> <tr><td>5</td><td>B+</td><td>25A</td></tr> </table>	W/CHARGER	AMS	DA	5	B+	25A	<table border="1" style="font-size: 8px; border-collapse: collapse;"> <tr><td>TRAILER</td><td>50A</td></tr> </table>	TRAILER	50A	<table border="1" style="font-size: 8px; border-collapse: collapse;"> <tr><td>4</td><td>B+</td><td>50A</td></tr> </table>	4	B+	50A	<table border="1" style="font-size: 8px; border-collapse: collapse;"> <tr><td>6</td><td>B+</td><td>50A</td></tr> </table>	6	B+	50A	<table border="1" style="font-size: 8px; border-collapse: collapse;"> <tr><td>1</td><td>B+</td><td>50A</td></tr> <tr><td>2</td><td>B+</td><td>50A</td></tr> <tr><td>3</td><td>B+</td><td>50A</td></tr> <tr><td>COA</td><td></td><td></td></tr> </table>	1	B+	50A	2	B+	50A	3	B+	50A	COA		
W/CHARGER	AMS	DA																													
5	B+	25A																													
TRAILER	50A																														
4	B+	50A																													
6	B+	50A																													
1	B+	50A																													
2	B+	50A																													
3	B+	50A																													
COA																															
<p>주의 CAUTION</p>																															
<p>91956-AR300</p>																															
<p>차량용 퓨즈만 사용하세요 USE THE DESIGNATED FUSE ONLY USE SOLO LOS FUSIBLES ESPECIFICADOS</p> <p>используйте только предназначенные предохранители استخدم الفيوز ذو القياس المناسب</p>																															
<p>점프 시동 상세 방법은 차량 취급설명서를 참조하십시오. For the details about jump start, refer to the owner's manual. Para más información acerca de arranque con otras de fuente consulte el manual del propietario</p> <p>См. руководство пользователя для дополнительной информации о запуске двигателя от внешнего источника. الخطوات من طريقة التشغيل بواسطة كابل مشترك مع بطارية خارجية ارجع دليل المستخدم</p>																															

OJK090019

Luggage compartment (Battery junction block)

Fuse Name	Symbol	Fuse Rating	Circuit Protected
TRAILER		50A	Trailer Connector
B+4	⁴ 	50A	ICU Junction Block (Fuse - F27, F31, F45)
B+1	¹ 	50A	ICU Junction Block (Long Term Load Latch Relay, Short Term Load Latch Relay, IPS1, IPS3, IPS4, IPS7)
B+3	³ 	50A	ICU Junction Block (Fuse - F25, F26, F33, F34, F35, F36, F41, F42, F43, F44)
B+5	⁵ 	125A	[LHD] E/R SUB Junction Block (B+) [RHD] E/R Junction Block (B+)
B+6	⁶ 	100A	Rear Junction Block (DCU Relay, Fuse - S1, F3, F6, F9, F12, F16, F19, F20, F22, F24, F25, F26)
AMS	AMS	10A	Battery Sensor

LIGHT BULBS

Consult an authorized retailer of Genesis Branded products to replace most vehicle light bulbs. It is difficult to replace vehicle light bulbs because other parts of the vehicle must be removed before you can get to the bulb. This is especially true for removing the headlamp assembly to get to the bulb(s). Removing/installing the headlamp assembly can result in damage to the vehicle.



WARNING

- Prior to working on a light, depress the foot brake, shift to P (Park), apply the parking brake, press the Engine Start/Stop button to the OFF position and take the key with you when leaving the vehicle to avoid sudden movement of the vehicle and to prevent possible electric shock.
- Be aware the bulbs may be hot and may burn your fingers.

NOTICE

Be sure to replace the burned-out bulb with one of the same wattage rating. Otherwise, it may cause damage to the fuse or electrical wiring system.

NOTICE

To prevent damage, do not clean the headlamp lens with chemical solvents or strong detergents.



Information - Headlamp desiccant (if equipped)

This vehicle is equipped with desiccant to reduce fogging inside the headlamp due to moisture. The desiccant is consumable and its performance may change based on the used period or environment. If fogging inside the headlamp due to moisture continues for a long time, we recommend that you consult an authorized retailer of Genesis Branded products.



Information

The headlamp and tail lamp lenses could appear frosty if the vehicle is washed after driving or the vehicle is driven at night in wet weather. This condition is caused by temperature difference between the lamp inside and outside and, it does not indicate a problem with your vehicle. When moisture condenses in the lamp, it will be removed after driving with the headlamp on. The removable level may differ depending on lamp size, lamp position and environmental condition. However, if moisture is not removed, we recommend that your vehicle is inspected by an authorized retailer of Genesis Branded products.

i Information

- A normally functioning lamp may flicker momentarily to stabilize the vehicle's electrical control system. However, if the lamp goes out after flickering momentarily, or continues to flicker, we recommend the system be checked by an authorized retailer of Genesis Branded products.
- The position lamp may not turn on when the position lamp switch is turned on, but the position lamp and headlamp switch may turn on when the headlamp switch is turned on. This may be caused by network failure or vehicle electrical control system malfunction. If this occurs, we recommend the system be checked by an authorized retailer of Genesis Branded products.

i Information

The headlamp aiming should be adjusted after an accident or after the headlamp assembly is reinstalled.

i Information

Traffic Change (For Europe)

The low beam light distribution is asymmetric. If you go abroad to a country with opposite traffic direction, this asymmetric part will dazzle oncoming car driver. To prevent dazzle, ECE regulation demand several technical solutions (ex. automatic change system, adhesive sheet, down aiming). This headlamps are designed not to dazzle opposite drivers. So, you need not change your headlamps in a country with opposite traffic direction.

Headlamp, position lamp, turn signal lamp, Daytime Running Light (DRL) replacement

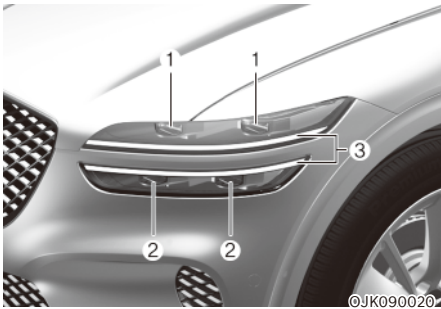

- (1) Headlamp (Low)
- (2) Headlamp (High/Low beam assist)
- (3) Position lamp/Daytime running light/ Turn signal lamp

If the LED lamp does not operate, we recommend that the system be inspected by an authorized retailer of Genesis Branded products.

The LED lamps cannot be replaced as a single unit because it is an integrated unit. The LED lamps has to be replaced with the unit.

A skilled technician should check or repair the LED lamp, for it may damage related parts of the vehicle.

Headlamp aiming (For Europe)

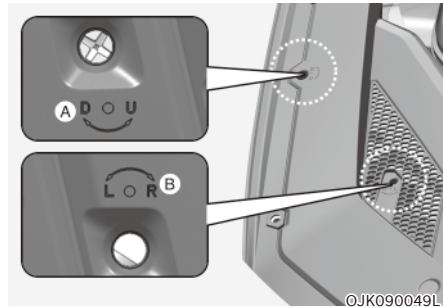

- [A] : Low beam and high beam vertical aiming
- [B] : Low beam and high beam horizontal aiming

1. Inflate the tires to the specified pressure and remove any loads from the vehicle except the driver, spare tire, and tools.
2. The vehicle should be placed on a flat floor.
3. Draw vertical lines (Vertical lines passing through respective head lamp centers) and a horizontal line (Horizontal line passing through center of head lamps) on the screen.
4. With the headlamp and battery in normal condition, aim the headlamps so the brightest portion falls on the horizontal and vertical lines.
5. To aim the low beam and high beam left or right, turn the driver clockwise or counterclockwise.

To aim the low beam and high beam up or down, turn the driver clockwise or counterclockwise.

Aiming point



OJK090040L

- H1 : Height between the head lamp bulb center and ground (Low beam)
 H2 : Height between the head lamp bulb center and ground (High beam)
 W1 : Distance between the two head lamp bulbs centers (Low beam)
 W2 : Distance between the two head lamp bulbs centers (High beam)

VEHICLE CONDITION	LAMP TYPE	H1	H2	W1	W2
WITHOUT DRIVER	LED PROJ	858	760	1644	1644
	LED PROJ + IFS	858	760	1644	1644
WITH DRIVER	LED PROJ	848	750	1644	1644
	LED PROJ + IFS	848	750	1644	1644

Headlamp low beam

■ Based on 10m screen

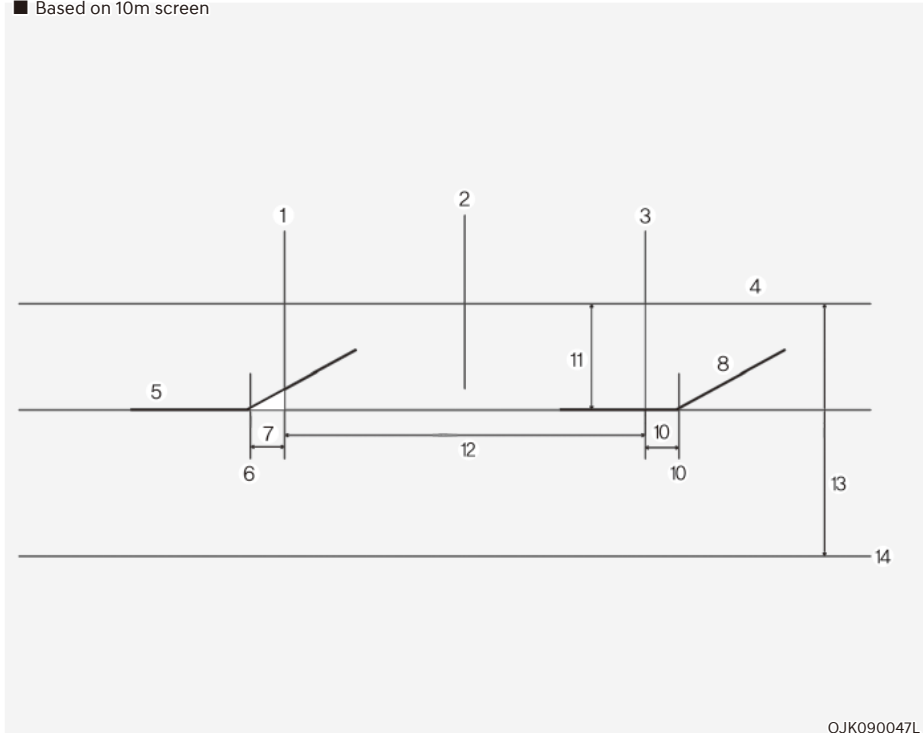

OJK090047L

- [1] : Vertical line of the left headlamp bulb center
- [2] : Car axis
- [3] : Vertical line of the right headlamp bulb center
- [4] : Horizontal line of headlamp bulb center
- [5] : cut-off line of left headlamp
- [6] : cut-off elbow of left headlamp
- [7] : distance between vertical line and cut-off elbow of left headlamp → 38mm
- [8] : cut-off line of right headlamp
- [9] : cut-off elbow of right headlamp
- [10] : distance between vertical line and cut-off elbow of right headlamp → 38mm
- [11] : 130
- [12] : W1 (Low beam)
- [13] : H1 (High beam)
- [14] : Ground

1. Turn the low beam on without driver aboard.
 2. Before aiming the car, hide the inner module of each side head lamps.
 3. The cut-off line should be projected in the cut-off line show in the picture.
 4. When aiming the low beam, vertical aiming should be adjusted after adjusting the horizontal aiming.
 5. If headlamp leveling device is equipped, adjust the headlamp leveling device switch to "o".
- * The high beam is aimed simultaneously when aiming the low beam.

Puddle lamp replacement

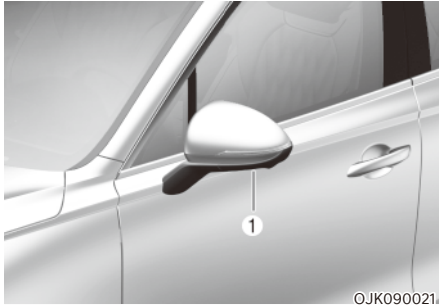

If the LED lamp (1) does not operate, we recommend that the system be inspected by an authorized retailer of Genesis Branded products.

The LED lamps cannot be replaced as a single unit because it is an integrated unit. The LED lamps has to be replaced with the unit.

A skilled technician should check or repair the LED lamp, for it may damage related parts of the vehicle.

Rear combination lamp replacement

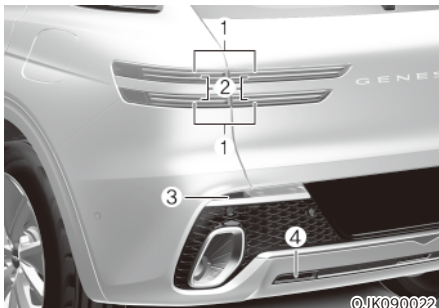

- (1) Stop lamp
- (2) Tail lamp/Stop lamp/Turn signal lamp
- (3) Side marker
- (4) Reverse lamp

If the LED lamp does not operate, we recommend that the system be inspected by an authorized retailer of Genesis Branded products.

The LED lamps cannot be replaced as a single unit because it is an integrated unit. The LED lamps has to be replaced with the unit.

A skilled technician should check or repair the LED lamp, for it may damage related parts of the vehicle.

Rear fog lamp replacement (if equipped)

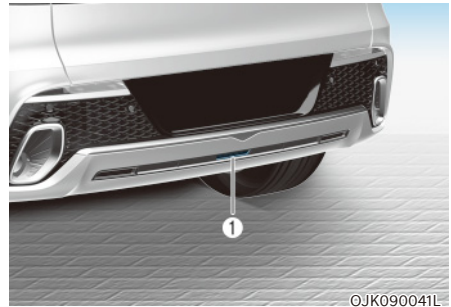

If the LED lamp (1) does not operate, we recommend that the system be inspected by an authorized retailer of Genesis Branded products.

The LED lamps cannot be replaced as a single unit because it is an integrated unit. The LED lamps has to be replaced with the unit.

A skilled technician should check or repair the LED lamp, for it may damage related parts of the vehicle.

High mounted stop lamp replacement

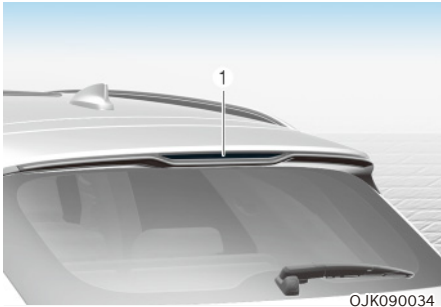

If the LED lamp (1) does not operate, we recommend that the system be inspected by an authorized retailer of Genesis Branded products.

The LED lamps cannot be replaced as a single unit because it is an integrated unit. The LED lamps has to be replaced with the unit.

A skilled technician should check or repair the LED lamp, for it may damage related parts of the vehicle.

License plate lamp replacement

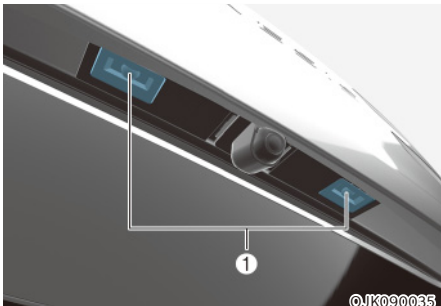

If the LED lamp (1) does not operate, we recommend that the system be inspected by an authorized retailer of Genesis Branded products.

The LED lamps cannot be replaced as a single unit because it is an integrated unit. The LED lamps has to be replaced with the unit.

A skilled technician should check or repair the LED lamp, for it may damage related parts of the vehicle.

Interior light replacement

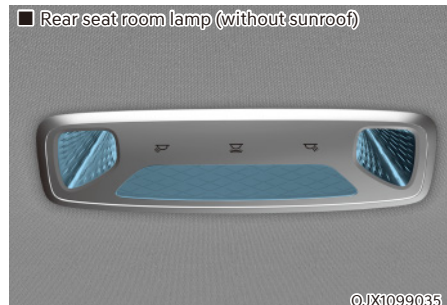

■ Rear seat personal lamp (with sunroof)



@JK1099036

■ Vanity mirror lamp



OHI078071

■ Glove box lamp

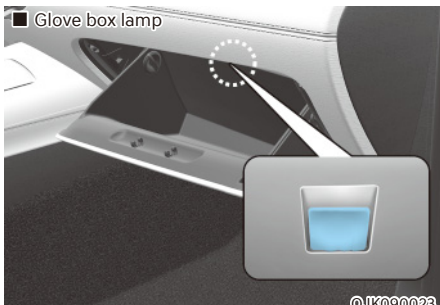

@JK090023

■ Inner door handle lamp / Mood lamp / Door courtesy lamp (if equipped)



@JK090025

■ Luggage compartment lamp

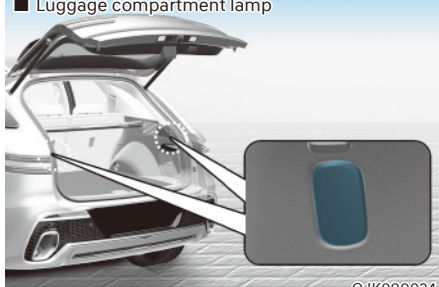

@JK090024

If the LED lamp does not operate, we recommend that the system be inspected by an authorized retailer of Genesis Branded products.

The LED lamps cannot be replaced as a single unit because it is an integrated unit. The LED lamps has to be replaced with the unit.

A skilled technician should check or repair the LED lamp, for it may damage related parts of the vehicle.

APPEARANCE CARE

Exterior care

NOTICE

If you park your vehicle near a stainless steel sign or glass facade building, the vehicle's exterior plastic parts such as a bumper, spoiler, garnish, lamp or outside rearview mirror might be damaged due to sunlight reflected from the sign or building. To prevent damage of the exterior plastic parts, you should avoid parking in areas where light may be reflected or use a car cover. (The exterior plastic parts applied to your vehicle may vary.)

Exterior general caution

It is very important to follow the label directions when using any chemical cleaner or polish. Read all warning and caution statements that appear on the label.

Finish maintenance

Washing

To help protect your vehicle's finish from rust and deterioration, wash it thoroughly and frequently at least once a month with lukewarm or cold water.

If you use your vehicle for off-road driving, you should wash it after each off-road trip. Pay special attention to the removal of any accumulation of salt, dirt, mud, and other foreign materials. Make sure the drain holes in the lower edges of the doors and rocker panels are kept clear and clean.

Insects, tar, tree sap, bird droppings, industrial pollution and similar deposits can damage your vehicle's finish if not removed immediately.

Even prompt washing with plain water may not completely remove all these deposits. A mild soap, safe for use on painted surfaces, should be used.

After washing, rinse the vehicle thoroughly with lukewarm or cold water. Do not allow soap to dry on the finish.

High-pressure washing

- When using high-pressure washers, make sure to maintain sufficient distance from the vehicle.
Insufficient clearance or excessive pressure can lead to component damage or water penetration.
- Do not spray the camera, sensors or its surrounding area directly with a high pressure washer. Shock applied from high pressure water may cause the device to not operate normally.
- Do not bring the nozzle tip close to boots (rubber or plastic covers) or connectors as they may be damaged if they come into contact with high pressure water.



WARNING

After washing the vehicle, test the brakes while driving slowly to see if they have been affected by water before getting on the road. If braking performance is impaired, dry the brakes by applying them lightly while maintaining a slow forward speed.

NOTICE

- Do not use strong soap, chemical detergents or hot water, and do not wash the vehicle in direct sunlight or when the body of the vehicle is warm.
- Be careful when washing the side windows of your vehicle.
- Especially, with high-pressure water, water may leak through the windows and wet the interior.
- To prevent damage to the plastic parts, do not clean with chemical solvents or strong detergents.

NOTICE

- Water washing in the engine compartment including high pressure water washing may cause the failure of electrical circuits located in the engine compartment.
- Never allow water or other liquids to come in contact with electrical/ electronic components inside the vehicle as this may damage them.

NOTICE

Matte paint finish vehicle (if equipped)
Automatic car wash which uses rotating brushes should not be used as this can damage the surface of your vehicle. A steam cleaner which washes the vehicle surface at high temperature may result the oil to adhere and leave stains that is difficult to remove.

Use a soft cloth (for example, microfiber towel or sponge) when washing your vehicle and dry with a microfiber towel. When you hand wash your vehicle, you should not use a cleaner that finishes with wax. If the vehicle surface is too dirty (sand, dirt, dust, contaminant, etc.), clean the surface with water before washing the car.

Waxing

A good coat of wax is a barrier between your paint and contaminate. Keeping a good coat of wax on your vehicle will help protect it.

Wax the vehicle when water will no longer bead on the paint.

Always wash and dry the vehicle before waxing. Use a good quality liquid or paste wax, and follow the manufacturer's instructions. Wax all metal trim to protect it and to maintain its luster.

Removing oil, tar, and similar materials with a spot remover will usually strip the wax from the finish. Be sure to re-wax these areas even if the rest of the vehicle does not yet need waxing.

NOTICE

- Wiping dust or dirt off the body with a dry cloth will scratch the finish.
- Do not use steel wool, abrasive cleaners, or strong detergents containing highly alkaline or caustic agents on chrome-plated or anodized aluminum parts. This may result in damage to the protective coating and cause discoloration or paint deterioration.

NOTICE

Matte paint finish vehicle (if equipped)

Do not use any polish protector such as a detergent, an abrasive and a polish. In case wax is applied, remove the wax immediately using a silicon remover and if any tar or tar contaminant is on the surface use a tar remover to clean. However, be careful not to apply too much pressure on the painted area.

Finish damage repair

Deep scratches or stone chips in the painted surface must be repaired promptly. Exposed metal will quickly rust and may develop into a major repair expense.

NOTICE

If your vehicle is damaged and requires any metal repair or replacement, be sure the body shop applies anti-corrosion materials to the parts repaired or replaced.

NOTICE

Matte paint finish vehicle (if equipped)

In case of matte paint finish vehicles, it is impossible to modify only the damaged area and repair of the whole part is necessary. If the vehicle is damaged and painting is required, we recommend that you have your vehicle maintained and repaired by an authorized retailer of Genesis Branded products. Take extreme care, as it is difficult to restore the quality after the repair.

Bright-metal maintenance

- To remove road tar and insects, use a tar remover, not a scraper or other sharp object.
- To protect the surfaces of brightmetal parts from corrosion, apply a coating of wax or chrome preservative and rub to a high luster.
- During winter weather or in coastal areas, cover the bright metal parts with a heavier coating of wax or preservative. If necessary, coat the parts with non-corrosive petroleum jelly or other protective compound.

Underbody maintenance

Corrosive materials used for ice and snow removal and dust control may collect on the underbody. If these materials are not removed, accelerated rusting can occur on underbody parts such as the fuel lines, frame, floor pan and exhaust system, even though they have been treated with rust protection.

Thoroughly flush the vehicle underbody and wheel openings with lukewarm or cold water once a month, after off-road driving and at the end of each winter. Pay special attention to these areas because it is difficult to see all the mud and dirt. It will do more harm than good to wet down the road grime without removing it. The lower edges of doors, rocker panels, and frame members have drain holes that should not be allowed to clog with dirt; trapped water in these areas can cause rusting.



WARNING

After washing the vehicle, test the brakes while driving slowly to see if they have been affected by water. If braking performance is impaired, dry the brakes by applying them lightly while maintaining a slow forward speed.

Aluminum wheel maintenance

The aluminum wheels are coated with a clear protective finish.

- Do not use abrasive cleaner, polishing compound, solvent, or wire brushes on aluminum wheels.
- Clean the wheel when it has cooled.
- Use only a mild soap or neutral detergent, and rinse thoroughly with water. Also, clean the wheels after driving on salted roads.
- Do not wash the wheels with high-speed car wash brushes.
- Do not use any cleaners containing acid or alkaline detergents.

Corrosion protection

Protecting your vehicle from corrosion

By using the most advanced design and construction practices to combat corrosion, Genesis Branded Vehicle produces vehicles of the highest quality. However, this is only part of the job. To achieve the long-term corrosion resistance your vehicle can deliver, the owner's cooperation and assistance is also required.

Common causes of corrosion

The most common causes of corrosion on your vehicle are:

- Road salt, dirt and moisture that is allowed to accumulate underneath the vehicle.
- Removal of paint or protective coatings by stones, gravel, abrasion or minor scrapes and dents which leave unprotected metal exposed to corrosion.

High-corrosion areas

If you live in an area where your vehicle is regularly exposed to corrosive materials, corrosion protection is particularly important. Some of the common causes of accelerated corrosion are road salts, dust control chemicals, ocean air and industrial pollution.

Moisture breeds corrosion

Moisture creates the conditions in which corrosion is most likely to occur. For example, corrosion is accelerated by high humidity, particularly when temperatures are just above freezing. In such conditions, the corrosive material is kept in contact with the vehicle surfaces by moisture that is slow to evaporate.

Mud is particularly corrosive because it is slow to dry and holds moisture in contact with the vehicle. Although the mud appears to be dry, it can still retain moisture and promote corrosion.

High temperatures can also accelerate corrosion of parts that are not properly ventilated so the moisture can be dispersed. For all these reasons, it is particularly important to keep your vehicle clean and free of mud or accumulations of other materials. This applies not only to the visible surfaces but particularly to the underside of the vehicle.

To help prevent corrosion

Keep your vehicle clean

The best way to prevent corrosion is to keep your vehicle clean and free of corrosive materials. Attention to the underside of the vehicle is particularly important.

- If you live in a high-corrosion area — where road salts are used, near the ocean, areas with industrial pollution, acid rain, etc.—, you should take extra care to prevent corrosion. In winter, hose off the underside of your vehicle at least once a month and be sure to clean the underside thoroughly when winter is over.
- When cleaning underneath the vehicle, pay particular attention to the components under the fenders and other areas that are hidden from view. Do a thorough job; just dampening the accumulated mud rather than washing it away will accelerate corrosion rather than prevent it. Water under high pressure and steam are particularly effective in removing accumulated mud and corrosive materials.
- When cleaning lower door panels, rocker panels and frame members, be sure that drain holes are kept open so that moisture can escape and not be trapped inside to accelerate corrosion.

Keep your garage dry

Don't park your vehicle in a damp, poorly ventilated garage. This creates a favorable environment for corrosion. This is particularly true if you wash your vehicle in the garage or drive it into the garage when it is still wet or covered with snow, ice or mud. Even a heated garage can contribute to corrosion unless it is well ventilated so moisture is dispersed.

Keep paint and trim in good condition

Scratches or chips in the finish should be covered with “touch-up” paint as soon as possible to reduce the possibility of corrosion. If bare metal is showing through, the attention of a qualified body and paint shop is recommended.

Bird droppings are highly corrosive and may damage painted surfaces in just a few hours. Always remove bird droppings as soon as possible.

Interior care***Interior general precautions***

Prevent caustic solutions such as perfume and cosmetic oil, from contacting the interior parts because they may cause damage or discoloration. If they do contact the interior parts, wipe them off immediately. See the instructions for the proper way to clean vinyl.

NOTICE

- **Never allow water or other liquids to come in contact with electrical/ electronic components inside the vehicle as this may damage them.**
- **When cleaning leather products (steering wheel, seats etc.), use neutral detergents or low alcohol content solutions. If you use high alcohol content solutions or acid/ alkaline detergents, the color of the leather may fade or the surface may get stripped off.**

Cleaning the upholstery and interior trim**Vinyl (if equipped)**

Remove dust and loose dirt from vinyl with a whisk broom or vacuum cleaner. Clean vinyl surfaces with a vinyl cleaner.

Fabric (if equipped)

Remove dust and loose dirt from fabric with a whisk broom or vacuum cleaner. Clean with a mild soap solution recommended for upholstery or carpets. Remove fresh spots immediately with a fabric spot cleaner. If fresh spots do not receive immediate attention, the fabric can be stained and its color can be affected. Also, its fire-resistant properties can be reduced if the material is not properly maintained.

NOTICE

Using anything but recommended cleaners and procedures may affect the fabric’s appearance and fire-resistant properties.

Leather (if equipped)

- Features of seat leather
 - Leather is made from the outer skin of an animal, which goes through a special process to be available for use. Since it is a natural product, each part differs in thickness or density.
 - Wrinkles may appear as a natural result of stretching and shrinking depending on the temperature and humidity.
 - The seat is made of stretchable fabric to improve comfort.
 - The parts contacting the body are curved and the side supporting area is high which provides driving comfort and stability.
 - Wrinkles may appear naturally from usage. It is not a fault of the products.

NOTICE

- **Wrinkles or abrasions which appear naturally from usage are not covered by warranty.**
- **Belts with metallic accessories, zippers or keys inside the back pocket may damage the seat fabric.**
- **Make sure not to wet the seat. It may change the nature of natural leather.**
- **Jeans or clothes which could bleach may contaminate the surface of the seat covering fabric.**
- Caring for the leather seats
 - Vacuum the seat periodically to remove dust and sand on the seat. It will prevent abrasion or damage of the leather and maintain its quality.
 - Wipe the natural leather seat cover often with dry or soft cloth.
 - Use of proper leather protector may prevent abrasion of the cover and helps maintain the color. Be sure to read the instructions and consult a specialist when using leather coating or protective agent.
 - Light colored (beige, cream beige) leather is easily contaminated and the stain is noticeable. Clean the seats frequently.
 - Avoid wiping with wet cloth. It may cause the surface to crack.
- Cleaning the leather seats
 - Remove all contaminations instantly. Refer to instructions below for removal of each contaminant.
 - Cosmetic products (sunscreen, foundation, etc.)
Apply cleansing cream on a cloth and wipe the contaminated spot. Wipe off the cream with a wet cloth and remove water with a dry cloth.
 - Beverages (coffee, soft drink, etc.)
Apply a small amount of neutral detergent and wipe until contaminations do not smear.
 - Oil
Remove oil instantly with absorbable cloth and wipe with stain remover used only for natural leather.
 - Chewing gum
Harden the gum with ice and remove gradually.
- Handling prime napa leather (if equipped)
Try to avoid excessive sunlight and heat exposure. Excessive sunlight and heat exposure naturally fades and dries out napa leather, causing wrinkles and discoloration. If the napa leather is wet with liquid, immediately clean it with lint-free cloth to minimize damage. Do not scratch the napa leather surface with a sharp object. If your napa leather seat is bright colored, it may be contaminated or stained from dyed materials such as jeans.

Interior wooden trim

- Use a wooden furniture protector (for example, wax, coating compound) to clean the interior wooden trim.
- Often wipe the interior wooden trim with a lint-free, clean cloth to maintain the unique wooden textures for a longer period of time.
- If you spill beverage (for example, water, coffee) over the interior wooden trim, immediately wipe it with clean, dry cloth.
- Sharp objects (for example, driver, knife), adhesive materials, or tapes may damage the interior wooden trim.
- Any strong impacts may damage the interior wooden trim.
- If the coating finish over the interior wooden trim is removed, moisture may damage or change wood traits.
- If the interior wooden trim is damaged, you may get a splinter from the wood surface. Therefore, you should immediately have replaced the damaged interior wooden trim. We recommend that you contact an authorized Retailer of Genesis Branded Products.

Cleaning the seat belt webbing

Clean the belt webbing with any mild soap solution recommended for cleaning upholstery or carpet. Follow the instructions provided with the soap. Do not bleach or re-dye the webbing because this may weaken the seat belt.

Cleaning the interior window glass

If the interior glass surfaces of the vehicle become fogged (that is, covered with an oily, greasy or waxy film), they should be cleaned with glass cleaner. Follow the directions on the glass cleaner container.

NOTICE

Do not scrape or scratch the inside of the rear window. This may result in damage to the rear window defroster grid.

EMISSION CONTROL SYSTEM

The emission control system of your vehicle is covered by a written limited warranty. Please see the warranty information contained in the Service Passport in your vehicle.

Your vehicle is equipped with an emission control system to meet all applicable emission regulations. There are three emission control systems, as follows.

- (1) Crankcase emission control system
- (2) Evaporative emission control system
- (3) Exhaust emission control system

In order to ensure the proper function of the emission control systems, it is recommended that you have your vehicle inspected and maintained by an authorized retailer of Genesis Branded products in accordance with the maintenance schedule in this manual.

NOTICE

For the Inspection and Maintenance Test (with Electronic Stability Control (ESC) system)

- **To prevent the vehicle from misfiring during dynamometer testing, turn the Electronic Stability Control (ESC) system off by pressing the ESC switch (ESC OFF light illuminated).**
- **After dynamometer testing is completed, turn the ESC system back on by pressing the ESC switch again.**

1. Crankcase emission control system

The positive crankcase ventilation system is employed to prevent air pollution caused by blow-by gases being emitted from the crankcase. This system supplies fresh filtered air to the crankcase through the air intake hose. Inside the crankcase, the fresh air mixes with blow-by gases, which then pass through the PCV valve into the induction system.

2. Evaporative emission control system

The Evaporative Emission Control System is designed to prevent fuel vapors from escaping into the atmosphere.

Canister

Fuel vapors generated inside the fuel tank are absorbed and stored in the onboard canister. When the engine is running, the fuel vapors absorbed in the canister are drawn into the surge tank through the purge control solenoid valve.

Purge Control Solenoid Valve (PCSV)

The purge control solenoid valve is controlled by the Engine Control Module (ECM); when the engine coolant temperature is low during idling, the PCSV closes so that evaporated fuel is not taken into the engine. After the engine warms-up during ordinary driving, the PCSV opens to introduce evaporated fuel to the engine.

3. Exhaust emission control system

The Exhaust Emission Control System is a highly effective system which controls exhaust emissions while maintaining good vehicle performance.

When the engine starts or fails to start, excessive attempts to restart the engine may cause damage to the emission system.

Engine exhaust (carbon monoxide) precautions

- Carbon monoxide can be present with other exhaust fumes. If you smell exhaust fumes of any kind in your vehicle, drive with all the windows fully open. Have your vehicle checked and repaired immediately.

WARNING

Engine exhaust gases contain carbon monoxide (CO). Though colorless and odorless, it is dangerous and could be lethal if inhaled. Follow the instructions on this page to avoid CO poisoning.

- Do not operate the engine in confined or closed areas (such as garages) any more than what is necessary to move the vehicle in or out of the area.
- When the vehicle is stopped in an open area for more than a short time with the engine running, adjust the ventilation system (as needed) to draw outside air into the vehicle.
- Never sit in a parked or stopped vehicle for any extended time with the engine running.
- When the engine stalls or fails to start, excessive attempts to restart the engine may cause damage to the emission control system.

Operating precautions for catalytic converters (if equipped)

WARNING

The exhaust system and catalytic converter are very hot during and immediately after the engine has been running. To avoid SERIOUS INJURY or DEATH:

- **Do not park, idle, or drive the vehicle over or near flammable objects, such as grass, vegetation, paper, leaves, etc. A hot exhaust system can ignite flammable items under your vehicle.**
- **Keep away from the exhaust system and catalytic converter or you may get burned.**

Also, do not remove the heat sink around the exhaust system, do not seal the bottom of the vehicle, and do not coat the vehicle for corrosion control. It may present a fire risk under certain conditions.

Your vehicle is equipped with a catalytic converter emission control device. To prevent damage to the catalytic converter and to your vehicle, take the following precautions:

- Use only UNLEADED FUEL for gasoline engines.
- Do not operate the vehicle when there are signs of engine malfunction, such as misfire or a noticeable loss of performance.
- Do not misuse or abuse the engine. Examples of misuse are coasting with the engine off and descending steep grades in gear with the engine off.
- Do not operate the engine at high idle speed for extended periods (5 minutes or more).
- Do not modify or tamper with any part of the engine or emission control system. We recommend that all inspections and adjustments must be made by an authorized retailer of Genesis Branded products.
- Avoid driving with an extremely low fuel level.

Running out of fuel could cause the engine to misfire, damaging the catalytic converter.

Gasoline Particulate Filter (GPF) (if equipped)

Gasoline Particulate Filter (GPF) system removes the soot in the exhaust gas.

The GPF system automatically burns (or oxidizes) the accumulated soot in accordance with driving situations, unlike a disposable air filter.

In other words, the accumulated soot is automatically purged out by the engine control system and by the high exhaust-gas temperature at normal/ high driving speeds.

However, when the vehicle is continually driven at repeated short distances or driven at low speed for a long time, the accumulated soot may not be automatically removed because of low exhaust gas temperature. In this case, the accumulated soot may reach a certain amount regardless of the soot oxidization process, then the GPF lamp () will illuminate.

The Gasoline Particulate Filter (GPF) lamp stops illuminating, when the driving speed exceeds 80 km/h (50 mph) with engine RPM 1,500 ~ 4,000 and the gear in the 3rd position or above for approximately 30 minutes.

When the GPF lamp starts to blink or the warning message “Check exhaust system” pops up even though the vehicle was driven as mentioned above, we recommend that you have the GPF system checked by an authorized retailer of Genesis Branded products.

With GPF lamp blinking for an extended period of time, it may damage the GPF system and lower the fuel economy.



CAUTION

We recommend you to use only the regulated gasoline fuels, when your vehicle is equipped with the GPF system.

When you use other gasoline fuels which contain unspecified additives, they may damage the GPF system and cause exhaust emission problems.

Diesel Particulate Filter (DPF) (if equipped)

Diesel Particulate Filter (DPF) system removes the soot in the exhaust gas.

The DPF system automatically burns (or oxidizes) the accumulated soot in accordance with driving situations, unlike a disposable air filter. In other words, the accumulated soot is automatically purged out by the engine control system and by the high exhaust-gas temperature at normal/high driving speeds.

However, when the vehicle is continually driven at repeated short distances or driven at low speed for a long time, the accumulated soot may not be automatically removed because of low exhaust gas temperature.

If this occurs, the accumulated soot is out of the detection range, the soot oxidization process does not occur, and the Diesel Particulate Filter (DPF) lamp () illuminates.

The Diesel Particulate Filter (DPF) lamp stops illuminating, when the driving speed exceeds 60 km/h (40 mph), or when the engine RPM is between 1,250 and 2,500 with the gear in the 2nd position or above for approximately 30 minutes.

When the DPF lamp continuously blinks or the warning message “Check exhaust system” pops up even though the vehicle was driven as mentioned above, we recommend that you have the DPF system checked by an authorized retailer of Genesis Branded products.

When the vehicle is continuously driven with the DPF lamp blinking for an extended period of time, it may damage the DPF system and lower the fuel economy.



CAUTION

We recommend you to use only the regulated diesel fuels, when your vehicle is equipped with the DPF system.

When you use other diesel fuels which are high in sulfurs (above 50 ppm) or that contain unspecified additives, they may damage the DPF system and cause white smoke emissions.

Lean NOx Trap (for diesel engine) (if equipped)

Lean NOx Trap (LNT) system removes nitrogen oxide from the exhaust gas. A smell can occur in the exhaust gas depending on the quality of the fuel, and it can degrade NOx reduction performance. Please use regulated automotive diesel fuel.

Selective Catalytic Reduction (SCR) (for diesel engine) (if equipped)

Selective Catalytic Reduction system catalytically converts NOx to nitrogen and water by using reduction agent, urea solution.

DEF level / Urea level

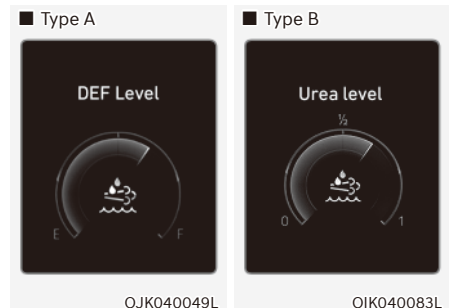

DEF (Diesel Exhaust Fluid) level gauge display shows the approximate amount of remaining urea solution inside the urea solution tank.

You can check the DEF level in the Utility view on the cluster.

Refer to “View Modes” section in chapter 4.

Low urea warning message

Warning message will appear in four steps on the cluster according to urea solution level in the tank.



First warning

The SCR (🚰) warning light and 'Low urea' warning message appears on the instrument cluster when urea level is low. Refill as soon as possible.



Second warning

If urea is not refilled after the first warning, the SCR (🚰) warning light and 'Refill urea' warning message appears on the instrument cluster when urea level is low. Refill as soon as possible.



Third warning

The SCR (🚰) warning light and 'Refill urea in 000 km or vehicle will not start / Refill urea in 000 km. Otherwise vehicle will not start' warning message appears on the instrument cluster when urea solution tank is nearly empty. Refill immediately.

The displayed driving distance (000 km) and actual driving distance may vary depending on driving habits and driving conditions.

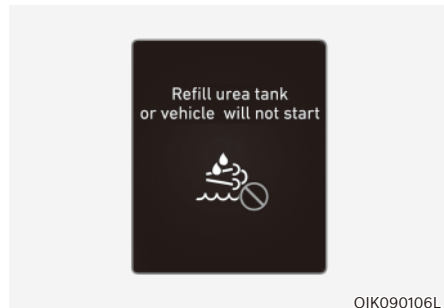

Fourth warning

The SCR (🚰) warning light and 'Refill urea tank or vehicle will not start / Refill urea tank. Otherwise vehicle will not start' warning message appears on the instrument cluster when urea solution tank is empty. The vehicle cannot be restarted once the engine is turned off. Refill immediately.

Selective Catalytic Reduction system malfunction

When there is a problem with the Selective Catalytic Reduction system such as disconnected electrical components, use of incorrect urea, etc. the following warning message will appear on the instrument cluster. If this occurs, we recommend that the system be inspected by an authorized retailer of Genesis Branded products.

If you continue to drive without the problem solved, it may adversely effect system performance or the vehicle cannot be restarted once the engine is turned off.

	Malfunction	Driving 50 km after malfunction
Urea system failure (= no urea injection)	Diesel Exhaust Fluid (DEF) system failure / Urea dosing system error	Check urea system
Incorrect urea detected (= abnormal urea)	Incorrect urea detected	Refill with correct urea in 000 km or vehicle will not start / Refill correct urea in 000 km. Otherwise vehicle will not start
Abnormal urea consumption (= post treatment failure)	Check urea system	Service urea system in 000 km or vehicle will not start / Service urea system in 000 km. Otherwise vehicle will not start

Restarting the vehicle

Vehicle restart restriction	
Low urea level	Refill urea tank or vehicle will not start / Refill urea tank. Otherwise vehicle will not start
Urea system failure (= no urea injection)	Service urea system in 000 km or vehicle will not start / Service urea system in 000 km. Otherwise vehicle will not start
Incorrect urea detected (= abnormal urea)	Refill with correct urea in 000 km or vehicle will not start / Refill with correct urea in 000 km. Otherwise vehicle will not start
Abnormal urea consumption (= post treatment failure)	Service urea system in 000 km or vehicle will not start / Service urea system in 000 km. Otherwise vehicle will not start

The vehicle can be restarted after the problem is solved. If the 'Refill urea tank or vehicle will not start / Refill urea tank. Otherwise vehicle will not start' warning message appears, refill the urea solution tank. After refilling the tank, press the Engine Start/Stop button to the ON position and wait until the message disappears. If the vehicle cannot be restarted after refilling urea, we recommend that the system be inspected by an authorized retailer of Genesis Branded products.

Adding urea solution

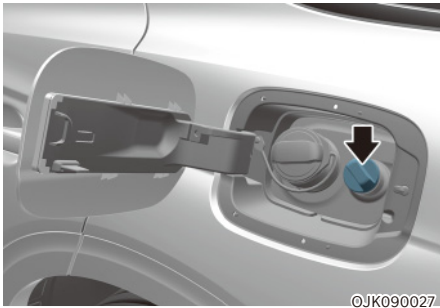

Refilling urea with a refill hose

1. Turn the vehicle off.
2. To open the urea solution tank cap, turn it counterclockwise.
3. Fully insert the refill hose and add urea.

Do not overfill.

4. To close the urea solution tank cap, turn it clockwise.

Refilling urea from a refill bottle

1. Turn the vehicle off.
2. To open the urea solution tank cap, turn it counterclockwise.
3. Add urea. Do not overfill.
4. To close the urea solution tank cap, turn it clockwise.

Use only specified urea solution (Refer to “Recommended Lubricants and Capacities” section in chapter 2).

NOTICE

To prevent damage to your vehicle:

- Use only specified urea solution. Never add any other urea solution than what has been specified.
- Be careful not to add urea solution into the fuel tank.
- While adding urea, be careful not to allow foreign substances to enter into the urea solution tank.
- Do not mix water or additives with the urea solution.
- Do not over fill the urea solution tank. In cold weather, the tank will expand if the urea freezes.

Storing urea solution

- Store urea solution only in containers made with the following materials.
 - DIN EN 10 088-1/-2/-3-specified CR-Ni steel
 - Mo-Cr-Ni steel
 - Polypropylene
 - Polyethylene
- Do not store urea solution in containers made with the following materials.
 - Aluminum, copper, copper alloy, non-alloyed still, and galvanized steel

Urea solution dissolves the metal materials, severely damaging the exhaust purification system.

Information

Urea solution is a water-soluble substance, which is inflammable, non-toxic, colorless and odorless.

NOTICE

- The following situations may damage the DPF system.
 - Fuels or any unauthorized liquids are added to the urea solution tank
 - Additives are mixed in the urea solution
 - Water is mixed in the urea solution
- Use only specified urea solution.

When any unauthorized urea solution is added to the tank, we recommend that you contact an authorized retailer of Genesis Branded products.

- When any foreign substances enter the urea solution tank, the following problems may occur.
 - Increased emission
 - DPF system malfunction
 - Engine failure
- Never add used urea solution as its quality cannot be guaranteed. Always add new urea solution.

**WARNING**

- Do not apply any external impact on the DPF system. It may damage the catalyst, which is equipped inside the DPF system.
- Do not modify the DPF system by redirecting or lengthening the exhaust pipe. It may adversely effect the DPF system.
- Avoid contact with the drained water from the exhaust pipe. The water is slightly acid and harmful to skin. If contacted, thoroughly wash it off.

- Any modification of the DPF system may cause system malfunction. The DPF system is controlled by a complex device.
- Wait for the DPF system to cool down before maintenance, as it is hot due to heat generation. Otherwise, it may cause skin burn.
- The Selective Catalytic Reduction system (for example, urea solution nozzle, urea solution pump, and DCU) operates for approximately 2 minutes more to eliminate the remaining urea solution inside, even after the engine is turned OFF. Before working on the vehicle, make sure that the Selective Catalytic Reduction system is completely turned OFF.
- Poor urea solution or unauthorized liquids may damage vehicle components, including the DPF system. Any unverified additives in the urea solution may clog the SCR catalyst and cause other malfunctions, which require the expensive DPF system to be replaced.



WARNING

- When the urea solution contacts with the eyes or the skin, you should thoroughly wash the contaminated skin area.
- When you swallow the urea solution, thoroughly rinse your mouth and drink a lot of fresh water. Then, immediately consult a doctor.
- When your cloth is contaminated with the urea solution, immediately change your cloth.
- When you have an allergic reaction to the urea solution, immediately consult a doctor.
- Keep children away from urea solution.
- When opening the urea solution tank cap at high outside temperatures, ammonia vapors may escape. Ammonia vapors have a pungent smell and primarily cause irritation of the:
 - Skin
 - Mucous membranes
 - EyesYou may experience a burning sensation in your eyes, nose and throat, as well as coughing and watering of the eyes. Do not inhale ammonia vapors. Do not allow urea solution to come in direct contact with your skin. It is hazardous to your health. Wash any affected areas off with plenty of clean water. If necessary, consult a doctor.
- When handling urea solution in closed space, ensure good ventilation. When the bottle of urea solution container is opened, pungent smelling fumes may escape

NOTICE

- Wipe off any urea solution spillage with water or dampened cloth. When the urea solution is crystalized, wipe it off with sponge or cloth, which is dampened in cold water.

When the urea solution spillage is exposed in the air for an extended period of time, it is crystalized in white, damaging the vehicle surface.
- When urea solution overflows onto vehicle surface, wash out vehicle surface with clean water to prohibit corrosion from occurring.
- Store the urea solution tank only in well ventilated locations. When urea solution is exposed to hot temperature at approximately 50°C (122°F) for an extended period of time (for example, under direct sunlight), chemical decomposition may occur, emitting ammonia vapor.
- In case the vehicle was parked at very low ambient temperature (below 11°C (33°F) for a long time, the urea solution will be frozen in the urea solution tank. With frozen urea, the tank level may not be detected correctly until the urea solution melts. Incorrect urea or diluted urea may increase the freezing point, so only use specified urea solution.

The time for the urea solution to melt varies in accordance with driving conditions and outside temperatures.

Index

A

Active sound design..... 6-64

Accessing your vehicle..... 5-5

 Immobilizer system..... 5-11

 Smart key 5-5

Air bag - supplemental restraint system 3-49

 Additional safety precautions..... 3-67

 Air bag warning labels 3-67

 How does the air bags system operate?..... 3-57

 SRS care..... 3-66

 What to expect after an air bag inflates..... 3-60

 Where are the air bags? 3-52

 Why didn't my air bag go off in a collision? 3-61

Air cleaner 9-37

 Filter replacement..... 9-37

Air conditioner compressor label..... 2-20

Air conditioning system..... 2-14

All Wheel Drive (AWD)..... 6-42

 All Wheel Drive (AWD) operation 6-42

 Emergency precautions 6-45

Appearance care..... 9-82

 Exterior care..... 9-82

 Interior care 9-87

Automatic climate control system 5-83

 Automatic temperature control mode..... 5-85

 Manual temperature control mode 5-86

 System maintenance..... 5-97

 System operation..... 5-95

Automatic transmission 6-12

 Automatic transmission operation..... 6-12

 Good driving practices 6-21

 LCD display messages (cluster)..... 6-18

 Paddle shifter (Manual shift mode)..... 6-20

B

Battery	9-41
Battery capacity label	9-43
Battery recharging	9-43
For best battery service	9-42
Reset items	9-44
Before driving.....	6-5
Before entering the vehicle	6-5
Before starting.....	6-5
Blind-Spot Collision-Avoidance Assist (BCA)	7-32
Blind- Spot Safety system malfunction and limitations.....	7-41
Blind- Spot Safety system operation.....	7-36
Blind-Spot Safety system settings.....	7-34
Blind-Spot View Monitor (BVM)	7-77
Blind-Spot View Monitor malfunction	7-78
Blind-Spot View Monitor operation.....	7-77
Blind-Spot View Monitor settings	7-77
Brake fluid	9-35
Checking the brake fluid level	9-35
Braking system	6-22
Anti-lock Brake System (ABS).....	6-31
Auto Hold.....	6-27
Disc brakes wear indicator	6-22
Downhill Brake Control (DBC)	6-38
Electronic Parking Brake (EPB)	6-23
Electronic Stability Control (ESC).....	6-32
Emergency Stop Signal (ESS)	6-37
Good braking practices	6-41
High performance brake.....	6-23
Hill-Start Assist Control (HAC).....	6-36
Multi-Collision Brake (MCB).....	6-37
Power-assist brakes	6-22
Vehicle Stability Management (VSM)	6-35
Built-in cam	5-123
Built-in Cam operation.....	5-124
Built-in Cam screen	5-126
Built-in Cam's settings.....	5-123
Bulb wattage	2-12

C

Cabin air filter..... 9-38
 Filter inspection..... 9-38
 Filter replacement..... 9-38
 Child Restraint System (CRS)..... 3-37
 Installing a Child Restraint System (CRS)..... 3-40
 Our recommendation: Children always in the rear 3-37
 Selecting a Child Restraint System (CRS)..... 3-38
 Climate control additional features..... 5-102
 Auto. Controls That Use Climate Control Settings (for driver’s seat)..... 5-104
 Auto defogging system 5-102
 Auto dehumidify 5-103
 Recirculating air when washer fluid is used 5-104
 Sunroof inside air recirculation 5-104
 Coasting 6-57
 Coasting operating conditions..... 6-57
 Coasting release conditions..... 6-58
 Coasting setting..... 6-57

D

Declaration of conformity..... 2-20
 Dimensions 2-11
 Door locks..... 5-15
 Automatic door lock and unlock features 5-19
 Child-protector rear door locks 5-20
 Deadlocks..... 5-19
 Electronic child safety lock..... 5-20
 Operating door locks from inside the vehicle 5-16
 Operating door locks from outside the vehicle 5-15
 Drive mode integrated control system (2WD)..... 6-59
 Drive mode..... 6-59
 Drive mode integrated control system (AWD)..... 6-61
 Drive mode..... 6-61
 Multi terrain mode..... 6-64
 Vehicle characteristic 6-63

Driver Attention Warning (DAW)	7-67
Driver Attention Warning malfunction and limitations.....	7-70
Driver Attention Warning operation.....	7-68
Driver Attention Warning settings	7-67

E

Electronically controlled suspension with road preview	6-48
Limitations of the system	6-49
System malfunction.....	6-49
Electronic control suspension.....	6-48
System malfunction.....	6-48
Electronic limited slip differential	6-47
Drive mode selection.....	6-47
Warning messages	6-47
Emergency commodity	8-34
Fire extinguisher.....	8-34
First aid kit	8-34
Tire pressure gauge	8-34
Triangle reflector.....	8-34
Emission control system.....	9-90
Crankcase emission control system	9-90
Diesel Particulate Filter (DPF).....	9-92
Evaporative emission control system.....	9-90
Exhaust emission control system	9-90
Gasoline Particulate Filter (GPF).....	9-92
Lean NOx Trap (for diesel engine)	9-93
Selective Catalytic Reduction (SCR) (for diesel engine).....	9-93
Engine.....	2-11
Engine compartment.....	9-4
Engine compartment (I).....	2-9
Engine compartment (II).....	2-10
Engine coolant/Liquid-cooled intercooler coolant	9-32
Changing coolant	9-34
Checking the coolant level	9-32
Engine number.....	2-19

Engine oil.....	9-28
Checking the engine oil and filter	9-31
Checking the engine oil level.....	9-28
Engine Start/Stop button.....	6-6
Engine Stop/Start button positions.....	6-7
Remote start	6-11
Starting the engine.....	6-8
Turning off the engine.....	6-10
Explanation of scheduled maintenance items.....	9-25
Exterior features.....	5-119
Roof side rails	5-119
Exterior features.....	5-48
Fuel filler door.....	5-58
Hood.....	5-48
Power tailgate.....	5-49
Smart tailgate	5-56
Exterior overview (I)	2-2
Exterior overview (II).....	2-3

F

Fingerprint authentication system.....	5-12
Fingerprint authentication system operation.....	5-13
Fingerprint authentication system settings.....	5-12
Limitations of the system.....	5-14
Used vehicle.....	5-14
Forward Attention Warning (FAW)	7-73
Forward Attention Warning malfunction and limitations	7-74
Forward Attention Warning operation.....	7-74
Forward Attention Warning settings	7-73
Forward Collision-Avoidance Assist (FCA).....	7-2
Forward Collision-Avoidance Assist malfunction and limitations	7-17
Forward Collision-Avoidance Assist operation	7-8
Forward Collision-Avoidance Assist settings	7-5
Forward/Reverse Parking Distance Warning (PDW)	7-144
Forward/Reverse Parking Distance Warning malfunction and precautions..	7-147
Forward/Reverse Parking Distance Warning operation	7-145
Forward/Reverse Parking Distance Warning settings.....	7-144

Fuel filter (for diesel engine)	9-36
Draining water from fuel filter	9-36
Fuel filter cartridge replacement	9-36
Fuel label	2-21
Diesel engine	2-21
Gasoline engine	2-21
Fuses	9-54
Engine compartment panel fuse replacement	9-56
Fuse/relay panel description	9-57
Instrument panel fuse replacement	9-55

H

Hazard warning flasher	8-3
Head-Up Display (HUD)	5-61
Head-up display information	5-61
Head-up display settings	5-61
Precautions while using the head-up display	5-62
High Beam Assist (HBA)	5-76
High Beam Assist malfunction and limitations	5-77
High Beam Assist operation	5-77
High Beam Assist settings	5-76
Highway Driving Assist (HDA)	7-108
Highway Driving Assist malfunction and limitations	7-118
Highway Driving Assist operation	7-110
Highway Driving Assist settings	7-109

I

Idle Stop and Go (ISG)	6-52
Calibrating the Battery Sensor	6-55
Forced to Restart Engine	6-55
ISG malfunction	6-55
ISG system off	6-54
ISG system operation	6-52
If the engine overheats	8-8
If the engine will not start	8-4

If you have a flat tire (with spare tire)	8-14
Changing tires	8-15
EC declaration of conformity for jack	8-21
Jack and tools	8-14
Jack label	8-20
If you have a flat tire (with Tire Mobility Kit)	8-22
Checking the tire inflation pressure	8-28
Components of the Tire Mobility Kit	8-24
Introduction	8-22
Notes on the safe use of the Tire Mobility Kit	8-23
Using the Tire Mobility Kit	8-25
Important safety precautions	3-2
Air bag hazards	3-2
Always wear your seat belt	3-2
Control your speed	3-2
Driver distraction	3-2
Keep your vehicle in safe condition	3-2
Restrain all children	3-2
In case of an emergency while driving	8-3
If the engine stalls at a crossroad or crossing	8-3
If the engine stalls while driving	8-3
If you have a flat tire while driving	8-4
Infotainment system	5-120
Antenna	5-120
Bluetooth® Wireless Technology	5-122
Infotainment system	5-121
Lexicon premium sound system	5-122
Steering wheel remote controls	5-120
USB Port	5-120
Voice recognition	5-121
Instrument cluster	4-4
Gauges and meters	4-5
Instrument cluster control	4-5
LCD display messages	4-27
Transmission shift indicator	4-10
Warning and indicator lights	4-11
Instrument panel overview (I)	2-6
Instrument panel overview (II)	2-7
Instrument panel overview (III)	2-8

Integrated memory system.....	5-26
Recalling memory positions.....	5-27
Resetting the system.....	5-27
Seat easy access.....	5-28
Storing memory positions	5-26
Intelligent Front-Lighting System (IFS).....	5-72
Intelligent Front-Lighting System malfunction and limitations.....	5-73
Intelligent Front-Lighting System operation.....	5-72
Intelligent Front-Lighting System settings.....	5-72
Intelligent Speed Limit Assist (ISLA)	7-62
Intelligent Speed Limit Assist malfunction and limitations.....	7-65
Intelligent Speed Limit Assist operation.....	7-63
Intelligent Speed Limit Assist settings.....	7-62
Interior features.....	5-107
AC Inverter.....	5-111
Ashtray	5-108
Cargo security screen	5-117
Clock	5-114
Coat hook	5-114
Cup holder.....	5-107
Floor mat anchor(s).....	5-115
Luggage net holder.....	5-116
Power outlet	5-109
Rear side window sunshades.....	5-116
Sunvisor.....	5-108
USB charger	5-110
Wireless smart phone charging system	5-112
Interior overview (I)	2-4
Interior overview (II)	2-5

J

Jump starting.....	8-5
--------------------	-----

L

Lane Following Assist (LFA)	7-104
Lane Following Assist malfunction and limitations.....	7-107
Lane Following Assist operation.....	7-105
Lane Following Assist settings.....	7-104

Lane Keeping Assist (LKA)	7-26
Lane Keeping Assist malfunction and limitations	7-30
Lane Keeping Assist operation.....	7-28
Lane Keeping Assist settings	7-26
Launch control	6-50
Launch Control activation.....	6-50
Limited use of Launch Control	6-51
Prerequisite for activation	6-50
LCD display.....	4-32
3D instrument cluster (for 12.3-inch 3D cluster)	4-40
LCD display control.....	4-32
Option menu.....	4-38
View modes.....	4-32
Light bulbs	9-74
Headlamp aiming	9-76
Headlamp, position lamp, turn signal lamp, Daytime Running Light (DRL) replacement	9-76
High mounted stop lamp replacement.....	9-80
Interior light replacement.....	9-80
License plate lamp replacement	9-80
Puddle lamp replacement	9-79
Rear combination lamp replacement.....	9-79
Rear fog lamp replacement	9-79
Lighting	5-63
Exterior lights.....	5-63
Interior lights.....	5-67
Welcome system.....	5-71
Load and speed capacity tires (for europe).....	2-14

M

Maintenance services.....	9-6
Owner maintenance precautions	9-6
Owner’s responsibility	9-6
Manual Speed Limit Assist (MSLA)	7-59
Manual Speed Limit Assist operation	7-59
Mirrors	5-33
Inside rearview mirror.....	5-33
Outside rearview mirrors.....	5-34
Reverse parking aid.....	5-36

N

Navigation-Based Smart Cruise Control (NSCC)	7-97
Limitations of Navigation-based Smart Cruise Control.....	7-100
Navigation-based Smart Cruise Control operation	7-98
Navigation-based Smart Cruise Control settings	7-97

O

Owner maintenance	9-7
Owner maintenance schedule.....	9-8

P

Pan-European eCall System (FOR EUROPE)	8-35
Information on data processing (FOR EUROPE).....	8-37
Pan-European eCall System (FOR EUROPE).....	8-38
Panorama sunroof	5-43
Closing the sunroof	5-46
Resetting the sunroof.....	5-47
Sliding the sunroof	5-45
Sunroof open warning	5-48
Sunshade	5-44
Tilting the sunroof	5-45

R

Rear Cross-Traffic Collision-Avoidance Assist (RCCA)	7-129
Rear Cross-Traffic Safety system malfunction and limitations	7-135
Rear Cross-Traffic Safety system operation	7-131
Rear Cross-Traffic Safety system settings	7-130
Rear View Monitor (RVM).....	7-120
Rear View Monitor malfunction and limitations.....	7-122
Rear View Monitor operation.....	7-121
Rear View Monitor settings.....	7-120
Recommended lubricants and capacities	2-15
Recommended SAE viscosity number.....	2-16

Remote Smart Parking Assist (RSPA)	7-157
Front radar	7-182
Rear corner radar	7-185
Remote Smart Parking Assist malfunction and limitations	7-177
Remote Smart Parking Assist operation	7-159
Remote Smart Parking Assist settings	7-158
Reverse Parking Collision-Avoidance Assist (PCA)	7-149
Reverse Parking Collision-Avoidance Assist malfunction and limitations ..	7-152
Reverse Parking Collision-Avoidance Assist operation	7-151
Reverse Parking Collision-Avoidance Assist settings	7-149
Reverse Parking Distance Warning (PDW)	7-140
Reverse Parking Distance Warning malfunction and precautions	7-142
Reverse Parking Distance Warning operation	7-141
Reverse Parking Distance Warning settings	7-140

S

Safe Exit Assist (SEA)	7-52
Safe Exit Assist malfunction and limitations	7-56
Safe Exit Assist operation	7-54
Safe Exit Assist settings	7-53
Safe Exit Warning (SEW)	7-46
Safe Exit Warning malfunction and limitations	7-49
Safe Exit Warning operation	7-48
Safe Exit Warning settings	7-47
Scheduled maintenance services	9-9
Maintenance under severe usage conditions (except Europe)	9-16
Maintenance under severe usage conditions (for Europe)	9-23
Normal maintenance schedule (except Europe)	9-10
Normal maintenance schedule (for Europe)	9-18
Seat belts	3-26
Additional seat belt safety precautions	3-34
Care of seat belts	3-36
Pre-Active Seat Belt (PSB)	3-33
Seat belt restraint system	3-29
Seat belt safety precautions	3-26
Seat belt warning light	3-27

Seats.....	3-3
Air ventilation seats.....	3-23
Front seats.....	3-7
Headrest.....	3-16
Rear seats.....	3-12
Safety precautions.....	3-6
Seat warmers.....	3-20
Semi active engine mount.....	6-64
Smart Cruise Control (SCC).....	7-79
Smart Cruise Control malfunction and limitations.....	7-91
Smart Cruise Control operation.....	7-84
Smart Cruise Control settings.....	7-80
Special driving conditions.....	6-65
Driving at night.....	6-66
Driving in flooded areas.....	6-67
Driving in the rain.....	6-66
Hazardous driving conditions.....	6-65
Highway driving.....	6-67
Reducing the risk of a rollover.....	6-68
Rocking the vehicle.....	6-65
Smooth cornering.....	6-66
Steering wheel.....	5-29
Electric Power Steering (EPS).....	5-29
Heated steering wheel.....	5-32
Horn.....	5-31
Tilt/Telescopic steering.....	5-30
Storage compartment.....	5-105
Center console storage.....	5-105
Glove box.....	5-105
Mobile phone holder.....	5-106
Sunglass holder.....	5-106
Surround View Monitor (SVM).....	7-123
Surround View Monitor malfunction and limitations.....	7-128
Surround View Monitor operation.....	7-126
Surround View Monitor settings.....	7-124

T

Theft-alarm system	5-22
Advanced Rear Occupant Alert (ROA).....	5-23
Declaration of Conformity	5-25
Tire Pressure Monitoring System (TPMS)	8-9
Changing a tire with TPMS.....	8-13
Check tire pressure.....	8-10
Low tire pressure position and tire pressure telltale.....	8-11
Low tire pressure warning light	8-11
Tire pressure monitoring system.....	8-10
TPMS (Tire Pressure Monitoring System) malfunction indicator	8-12
Tires and wheels	2-13
Tires and wheels	9-45
Check tire inflation pressure	9-46
Low aspect ratio tires	9-53
Recommended cold tire inflation pressures	9-45
Tire care.....	9-45
Tire maintenance	9-49
Tire replacement.....	9-48
Tire rotation.....	9-47
Tire sidewall labeling	9-50
Tire traction	9-49
Wheel alignment and tire balance.....	9-48
Wheel replacement.....	9-49
Tire specification and pressure label	2-19
Towing	8-29
Emergency towing	8-31
Removable towing hook	8-30
Towing service	8-29
Trailer towing	6-74
Driving with a trailer.....	6-79
If you decide to pull a trailer?	6-75
Maintenance when towing a trailer	6-82
Trailer towing equipment.....	6-78

U

UAE ECALL System (FOR UAE)	8-42
Information on data processing (FOR UAE)	8-44
UAE ECALL System (FOR UAE)	8-45

V

Vehicle certification label	2-18
Vehicle Identification Number (VIN)	2-18
Vehicle Settings (infotainment system)	4-43
Setting your vehicle	4-43
Vehicle weight	6-83
Overloading	6-83
Vehicle weight and luggage volume	2-14

W

Washer fluid	9-36
Checking the washer fluid level	9-36
Windows	5-38
Power windows	5-40
Windshield defrosting and defogging	5-99
Defogging logic	5-100
Rear window defroster	5-101
To defog inside windshield	5-99
To defrost outside windshield	5-100
Winter driving	6-69
Snow or icy conditions	6-69
Winter precautions	6-72
Wiper blades	9-39
Blade inspection	9-39
Blade replacement	9-39
Wipers and washers	5-79
Front windshield washers	5-81
Front windshield wipers	5-79
Rear window wiper and washer	5-82